



# Instrukcja montażu

---

Moskitiera przesuwna – wariant 1.

Dostawa powinna zawierać:

1.

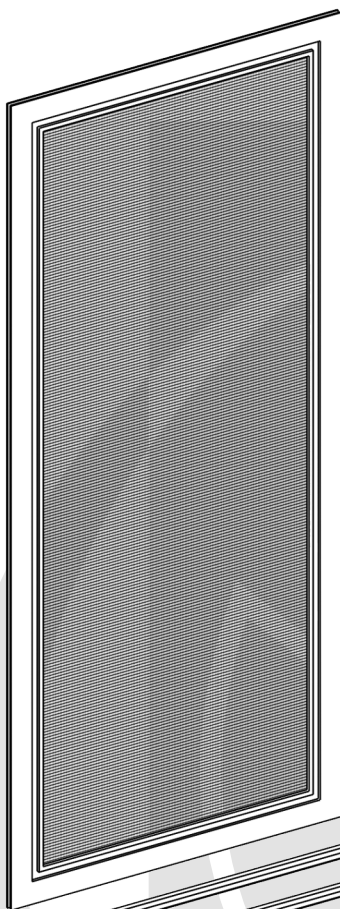

2.

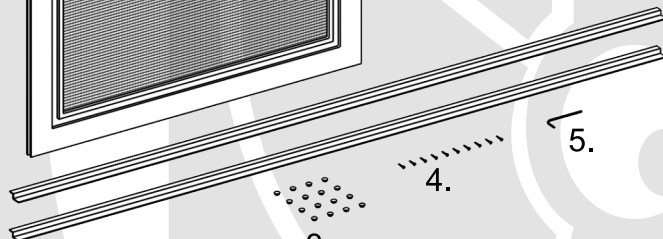

3.



4.

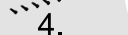

5.

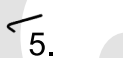

1. Moskitiera.
  2. Prowadnice.
  3. Zaślepki prowadnic.
  4. Śruby (kołki\*).
  5. Klucz imbus 2 mm.
- \* kołki – brak w komplecie, dostosować rodzaj mocowania do powierzchni montażu.

3.

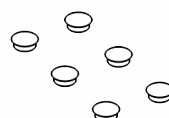

4.



\*



5.

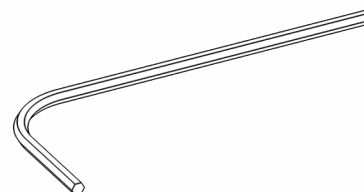

Wymiary podawane przy składaniu zamówienia:

– szerokość ramki

– wysokość ramki

– długość prowadnic.

Prowadnice. W zależności od wybranej konfiguracji w dostawie mogą być:

– górna:

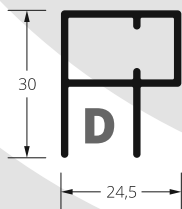
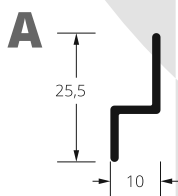

– dolna:

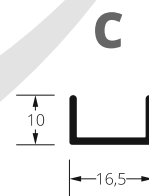
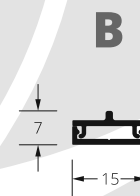
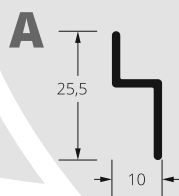

Przykładowe konfiguracje prowadnic.

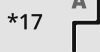

\* są to wartości, które należy dodać do wysokości ruchomej ramy moskitiery aby otrzymać wysokość całkowitą moskitiery w poszczególnych konfiguracjach prowadnic.

Montaż prowadnicy górnej.

Prowadnica A.

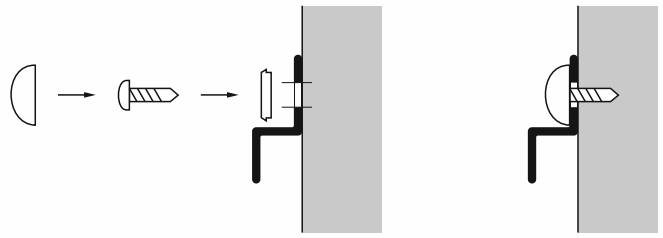

**A**

Prowadnica D

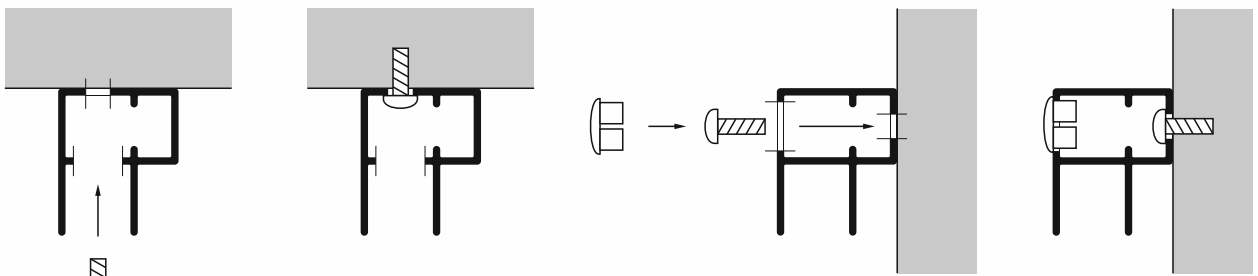

**D**

Montaż prowadnicy dolnej.

Prowadnica A

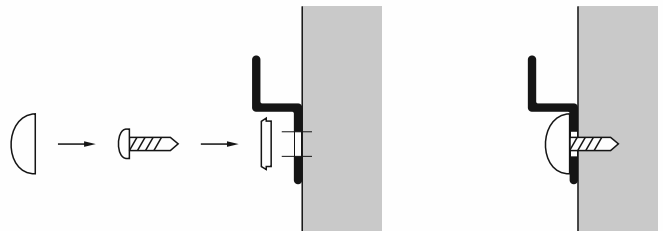

**A**

Prowadnica B

**B**

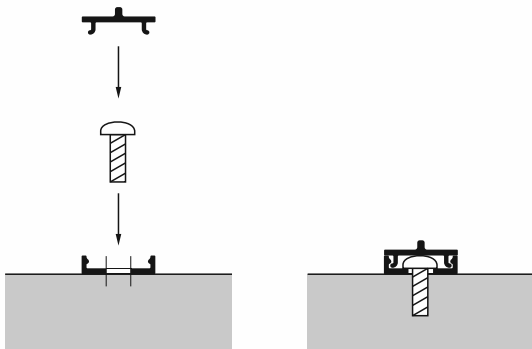

Prowadnica C

**C**

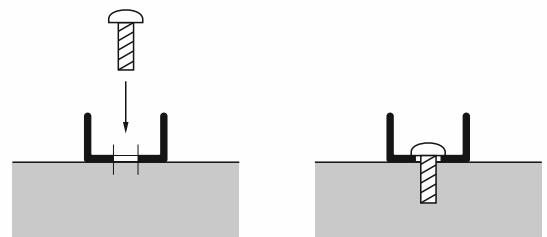

Przykręcenie prowadnic.

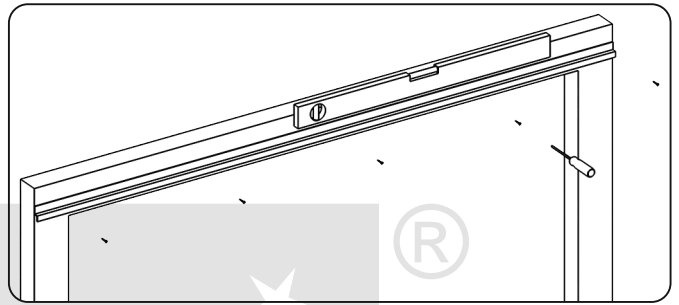
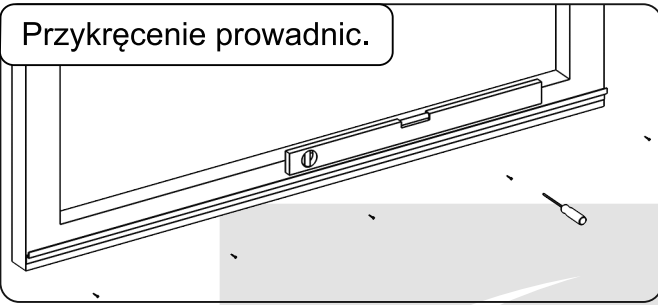

Montaż moskitiery.

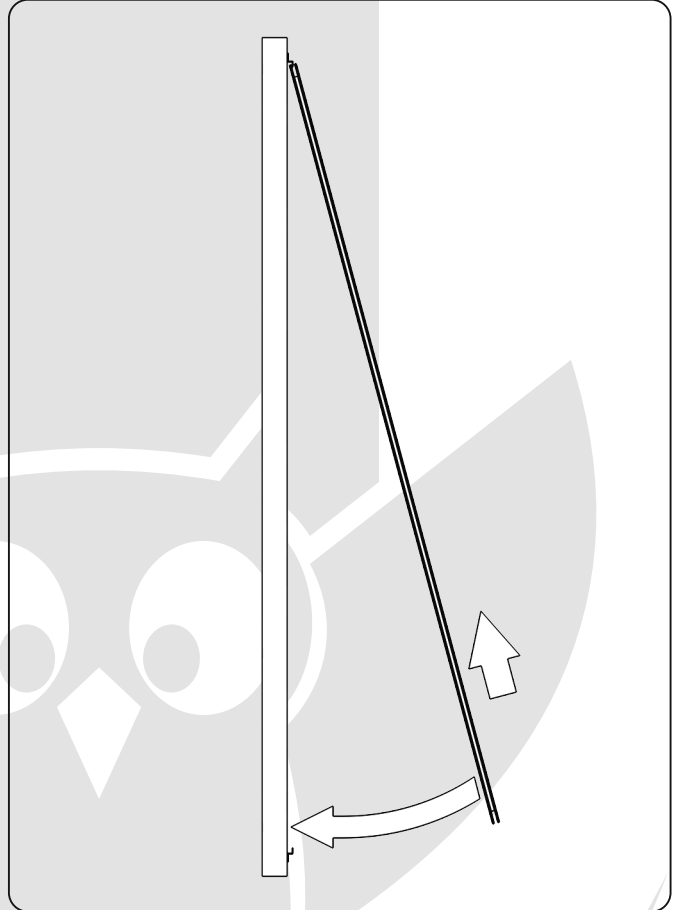

Blokowanie moskitiery.

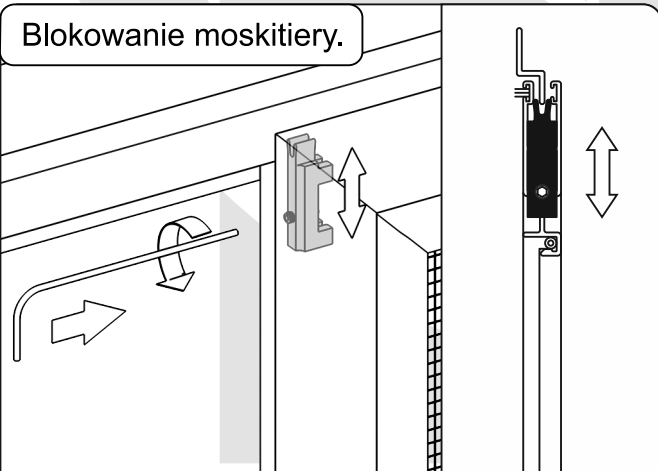

Należy zablokować moskitierę na prowadnicy za pomocą elementu prowadzącego (w górnej i dolnej części ramy). Zachować minimalny luz względem prowadnicy.

Poziomowanie moskitiery.

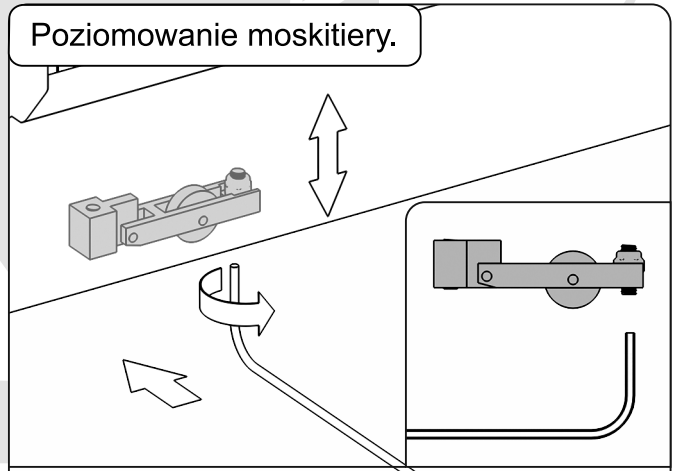

Korekcja kąta pochylenia moskitiery odbywa się poprzez regulację wkrętem dociskowym w rolce jezdnej za pomocą klucza 2 mm.



Fart Produkt Sp. z o. o. Sp. k.  
ul. Towarowa 3, 87-100 Toruń  
tel. +48 56 623 55 77, fax +48 56 649 57 23  
e-mail: [biuro@fartprodukt.pl](mailto:biuro@fartprodukt.pl)  
[www.fartprodukt.pl](http://www.fartprodukt.pl)