

---

## Premium SCREEN, ZIP guidance

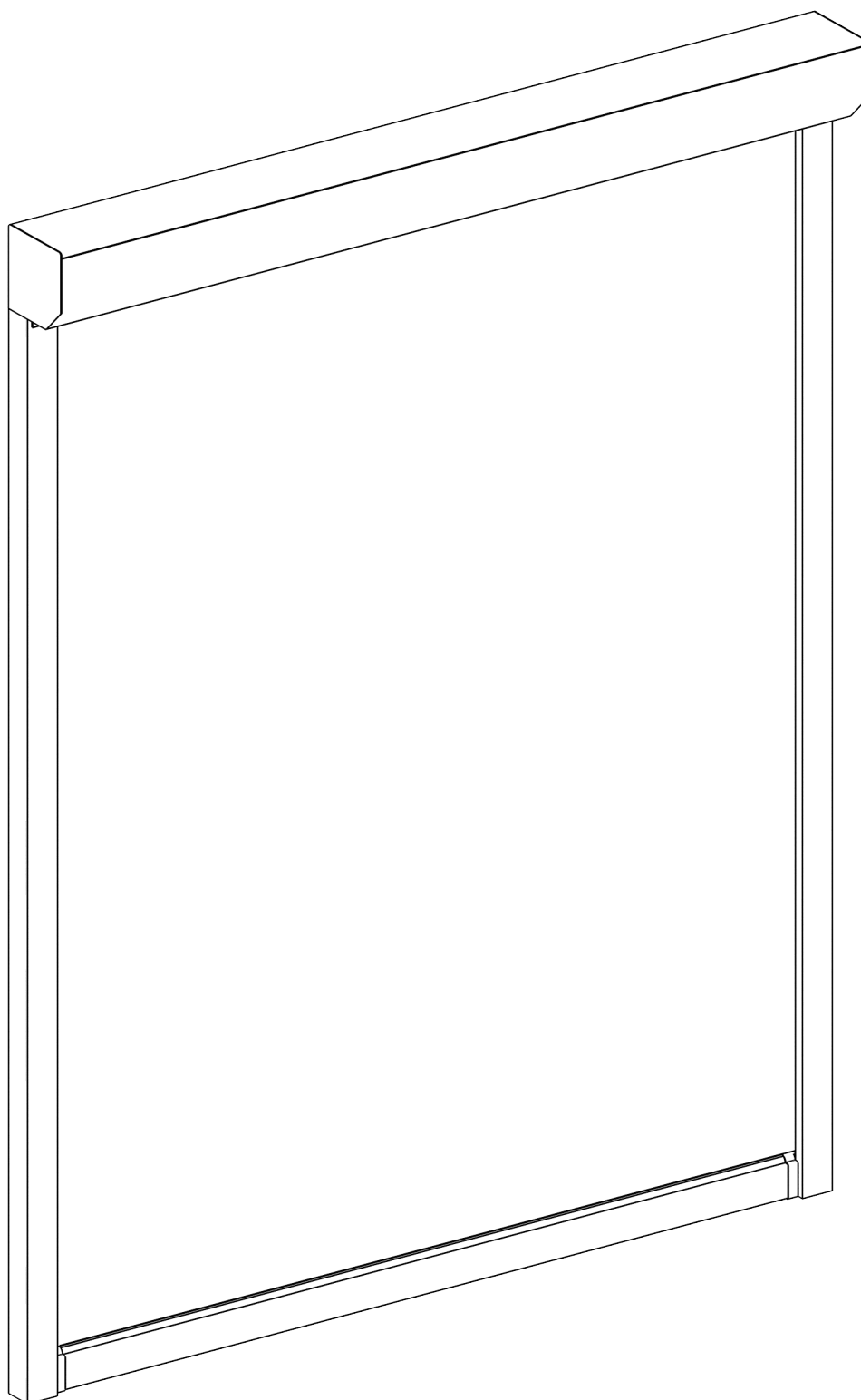

The delivery should include:

1. Cassette with cover.
2. Sideguides.

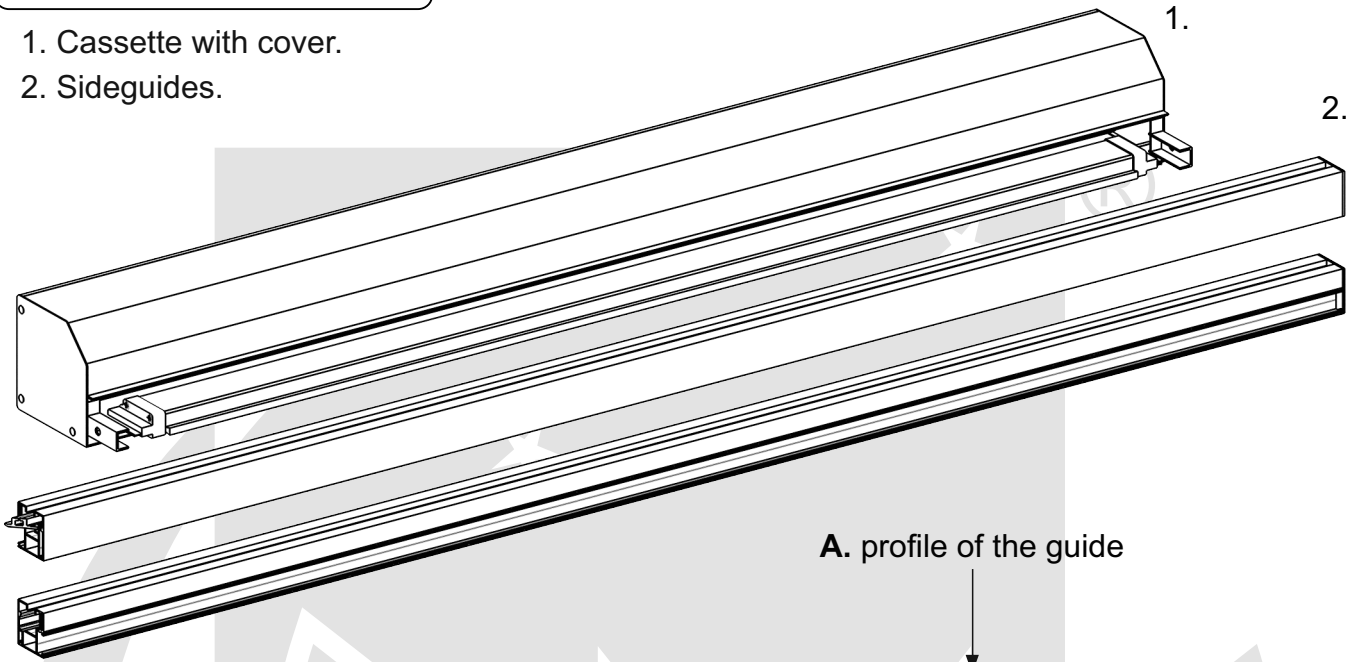

Construction of a 3-part guide in a ZIP-System:

A. profile of the guide

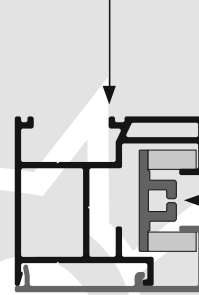

C. guiding ZIP insert

B. revision profile of the guide

A. profile of the guide

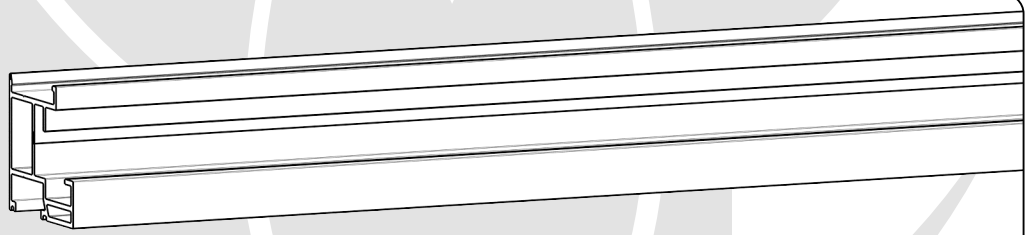
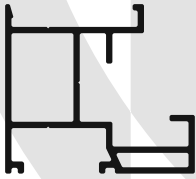

B. revision profile of the guide

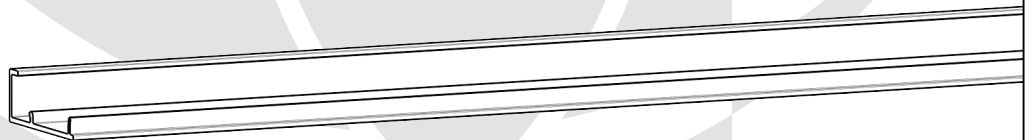

C. guiding ZIP insert



**Assembling the cassette and guides.**

1. Before assembling the cassette and guides, disassemble the revision profiles of the guides and remove the ZIP guide inserts.
2. Insert the cassette into the guides.
3. Twist the cassette and the guides together.

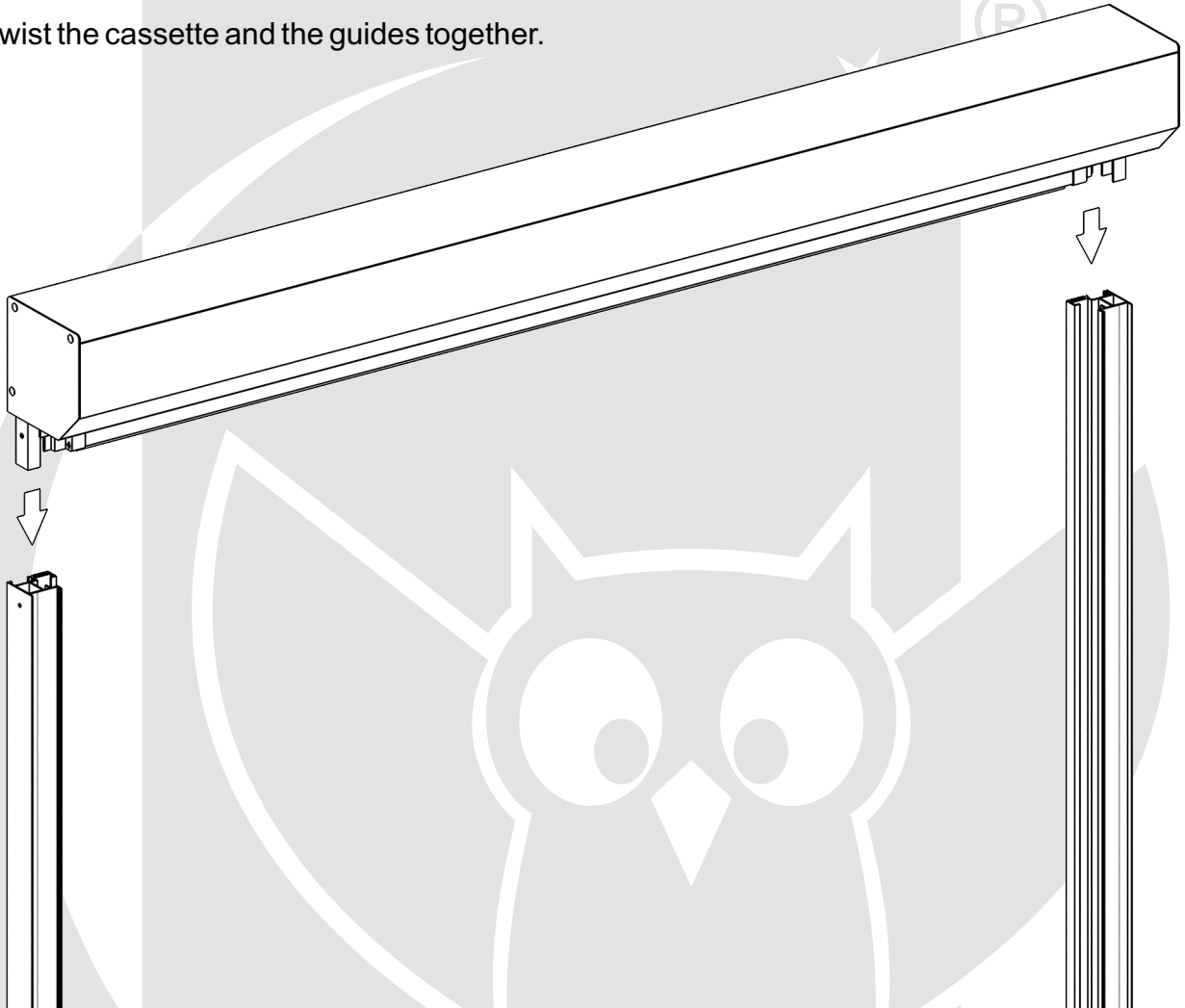

4,8 x 13 mm

Cassette mounting clip (125 mm cassettes only).

By cassettes 125 mm high and  $\geq 105$  mm wide, the cassette mounting clips can be used. Clips facilitate installation and reduce the load on the cassette brackets, and the box can be hung on them independently of the brackets.

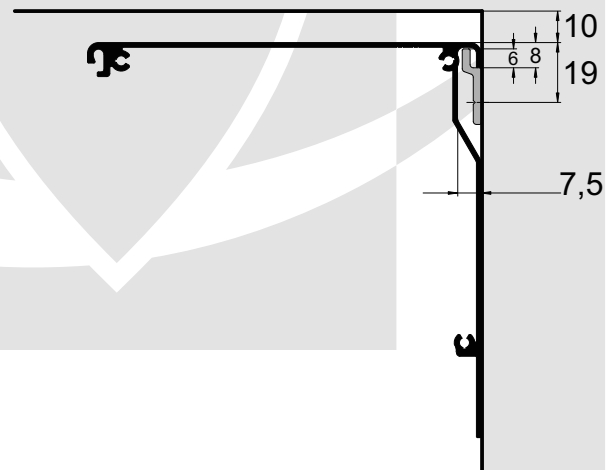
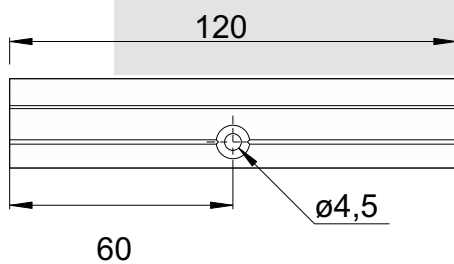
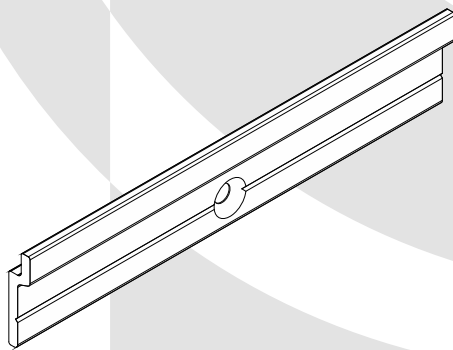
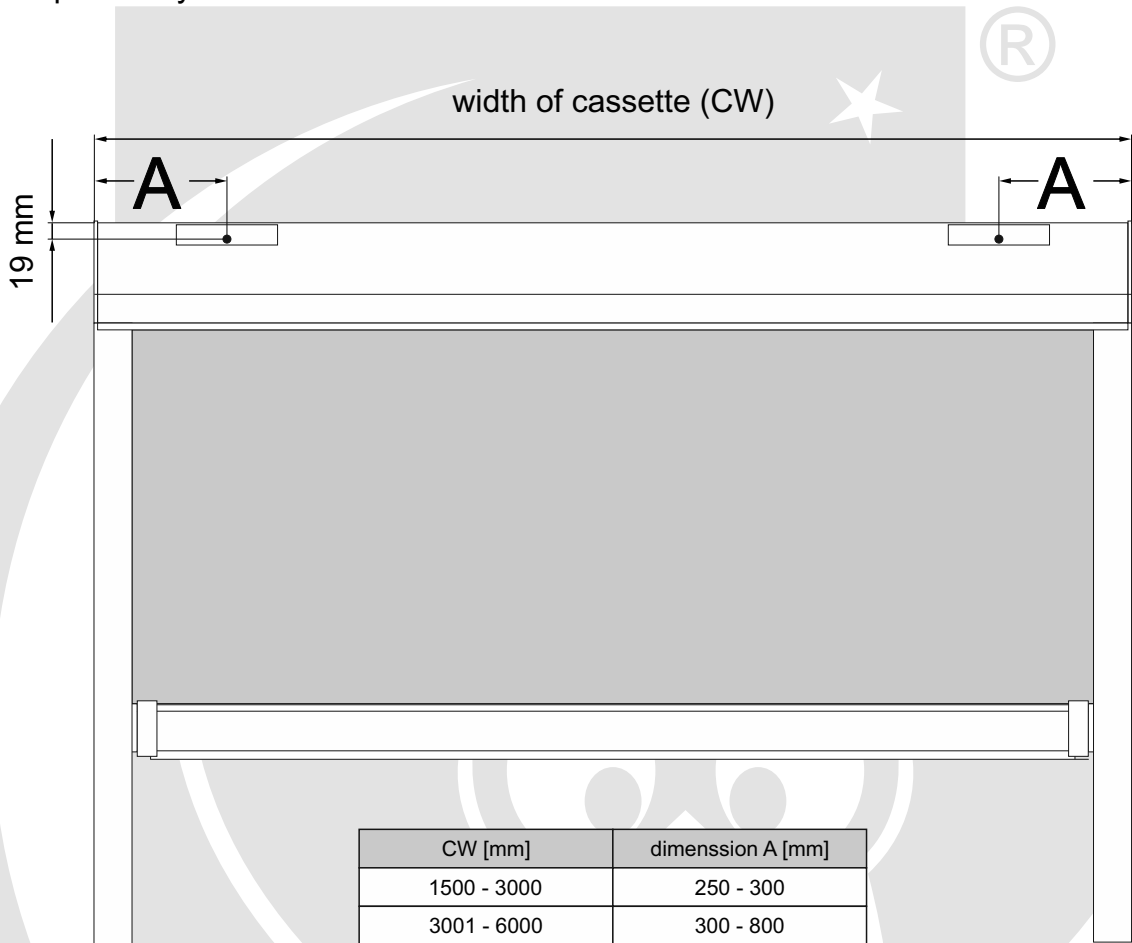

Mounting the SCREEN blind (remember to connect the power cable!).

### Installation of guides with PVC clips.

The clips should be screwed with the use of appropriately selected mounting accessories.

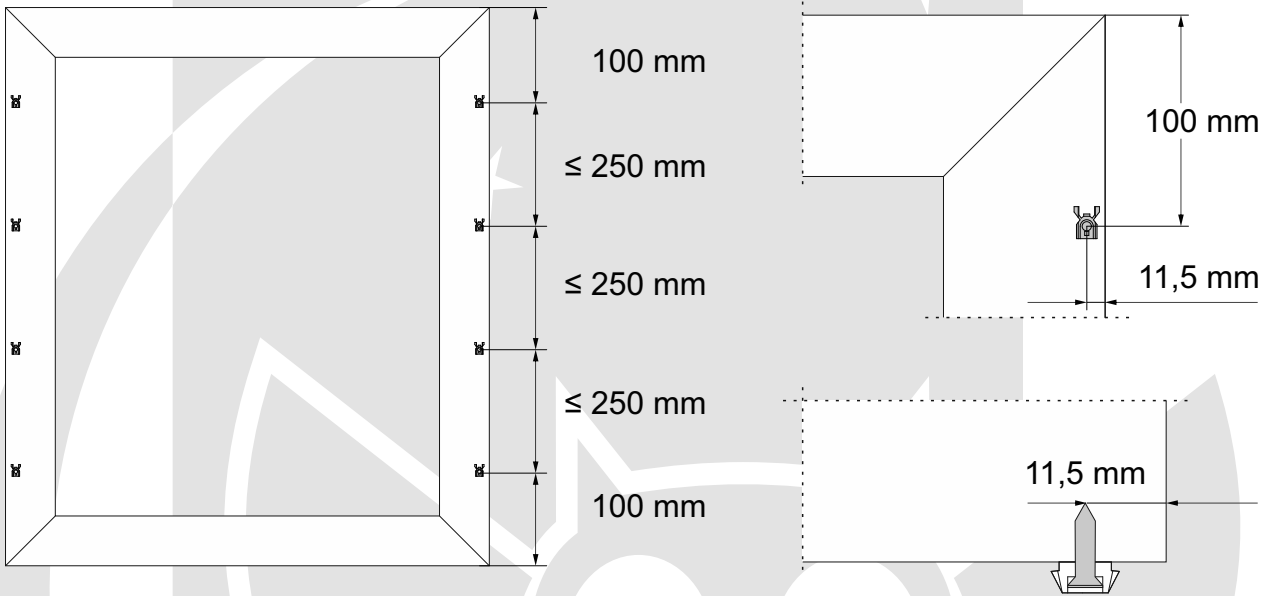
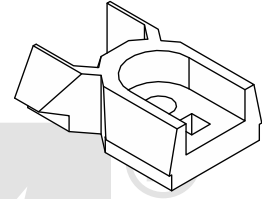

After mounting the mounting clips, slide the cover on them and "latch" it on them.

**Warning!** Make sure that the rails are screwed vertically parallel to each other; that the cassette is mounted horizontally and the diagonals between the guides are equal.

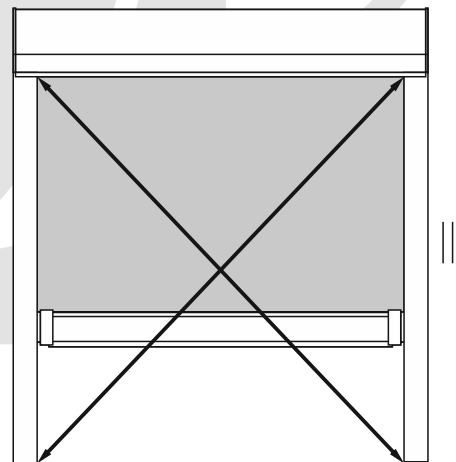
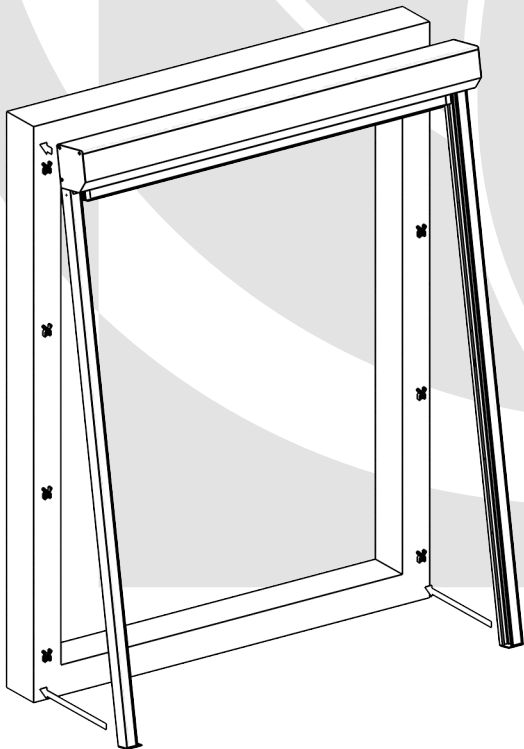

Mounting the SCREEN blind (remember to connect the power cable!).

### Installation of guides with using of the screws.

The guides should be screwed with the use of appropriately selected mounting accessories. They already have the mounting holes prepared in accordance with the selected mounting type (frontal / lateral mounting).

#### Frontal mounting.

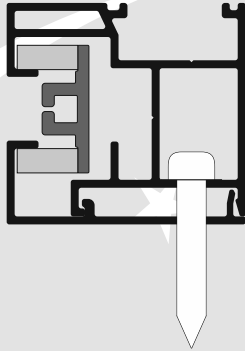

#### Lateral mounting.

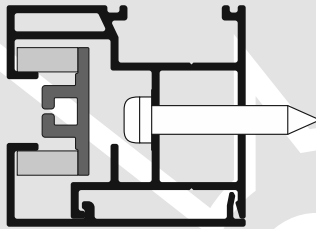

**Warning!** Make sure that the rails are screwed vertically parallel to each other; that the cassette is mounted horizontally and the diagonals between the guides are equal.

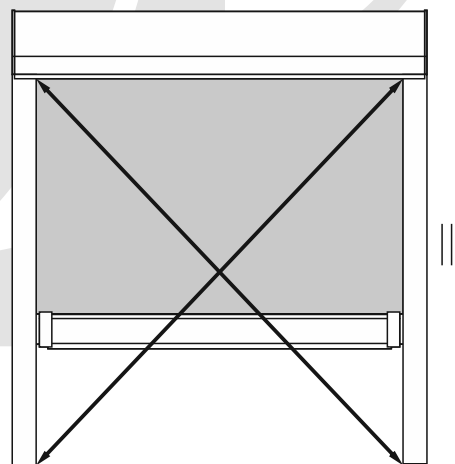
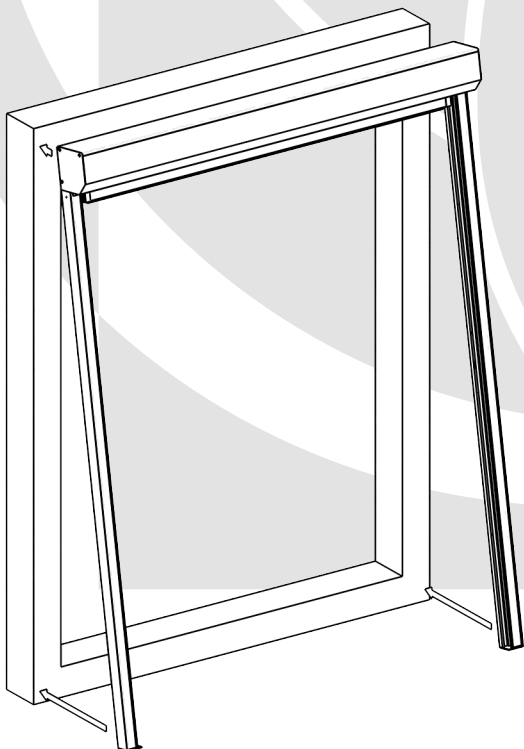

Preparing of the ZIP system and putting the guides together.

After slipping on the guides, lower the fabric to insert it into the guiding ZIP insert.



After lowering the fabric, insert it into the guiding ZIP insert and place the insert in the guide.

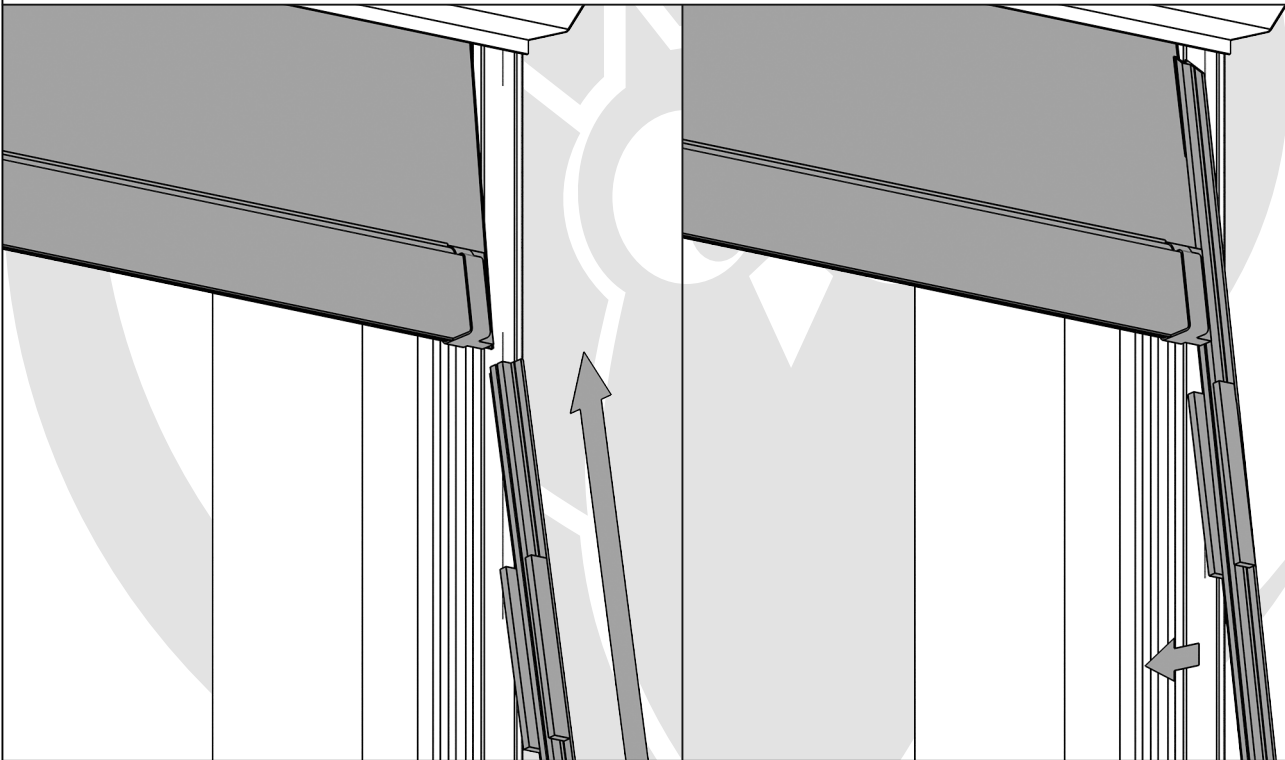

After that, latch the revision profile of the guides.

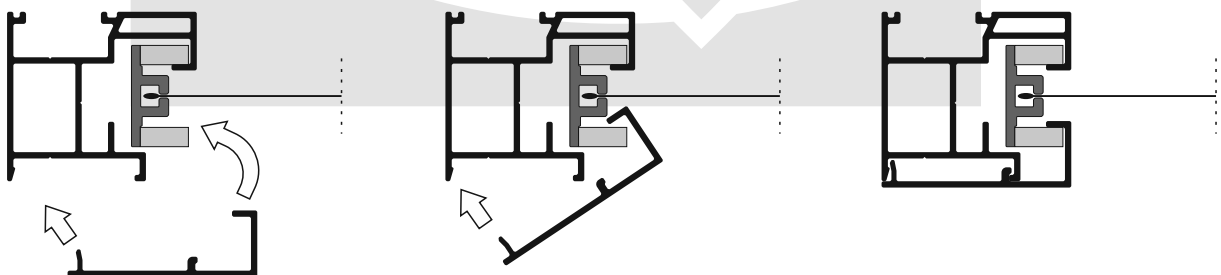



Fart Produkt Sp. z o. o. Sp. k.  
ul. Towarowa 3, 87-100 Toruń  
tel. +48 56 623 55 77  
e-mail: [export@fartprodukt.pl](mailto:export@fartprodukt.pl)  
[www.fartprodukt.pl](http://www.fartprodukt.pl)