

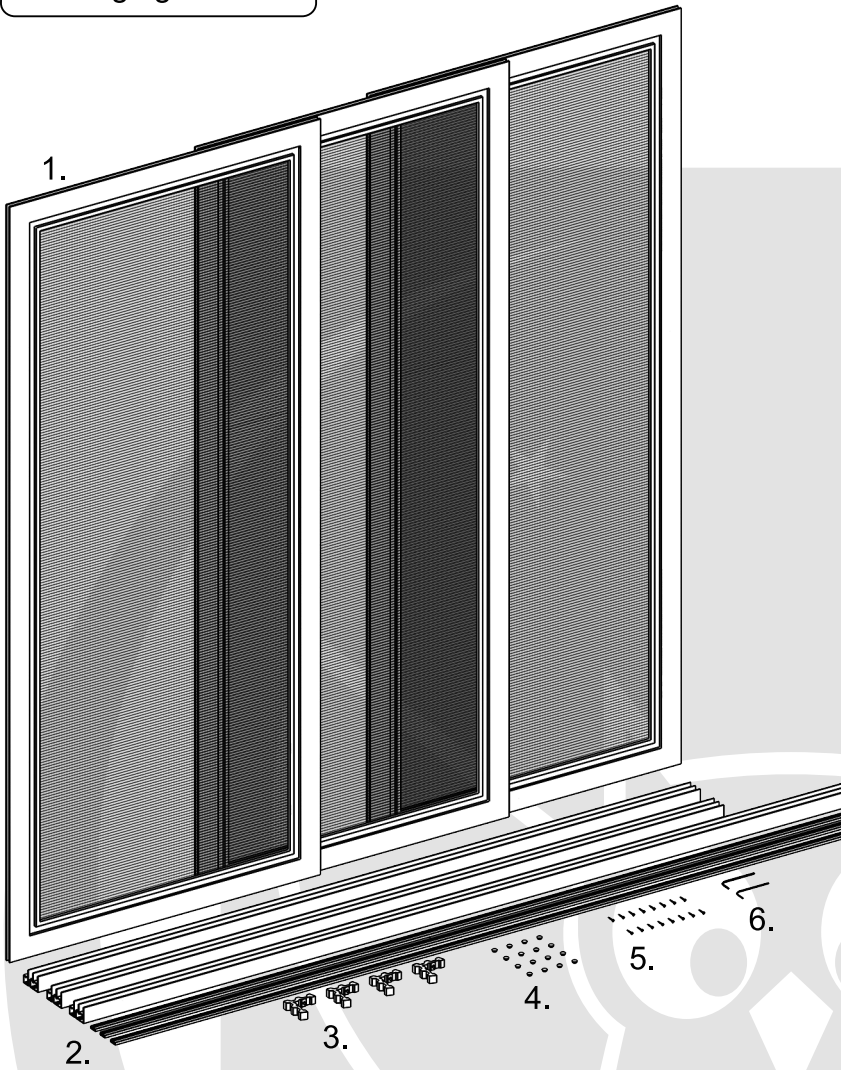

Installation instructions

Sliding insect screen - version 6

Packaging content:



1. Insect screen.
2. Side tracks.
3. Inner corner.
4. Side track caps.
5. Screws (wall plugs*).
6. Allen keys 2 mm and 2,5 mm.

* wall plugs – not included, use suitable wall plugs.

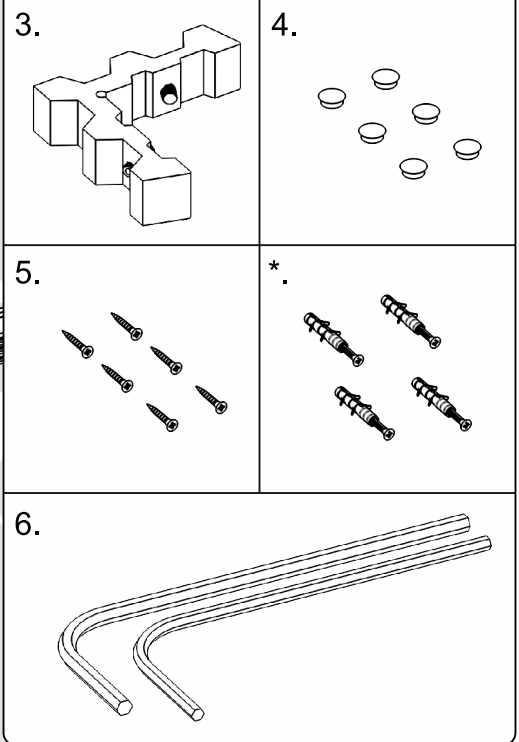

Dimensions given by placing the order:
– outer width and height of the frame.

Guides. Depending on the selected configuration, the delivery may include:

– top and lateral frame:

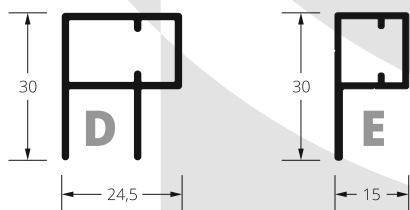

– only bottom:

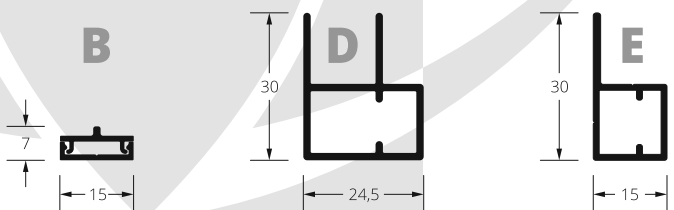

Example guides configuration:

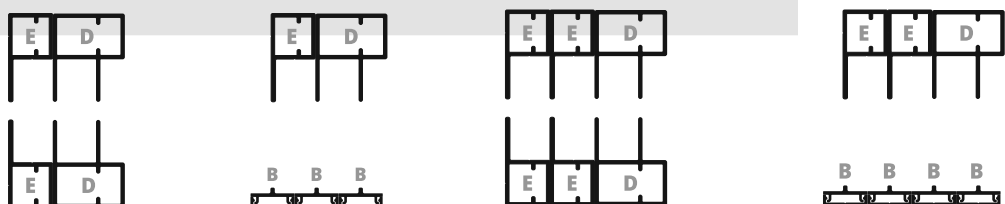

Installation of top guides / lateral frame.

DiE

Set of side tracks E and D.

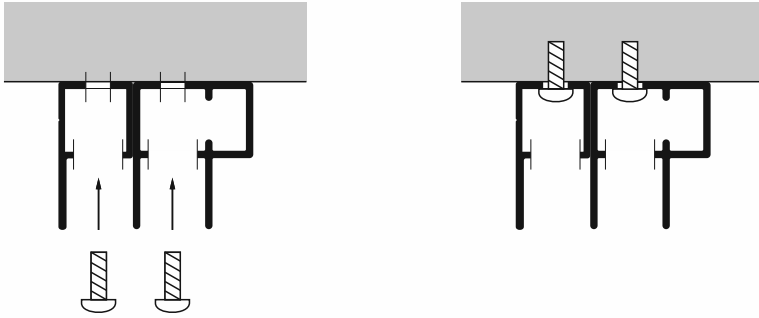

Fastening lower side tracks.

B

Set of side tracks B.

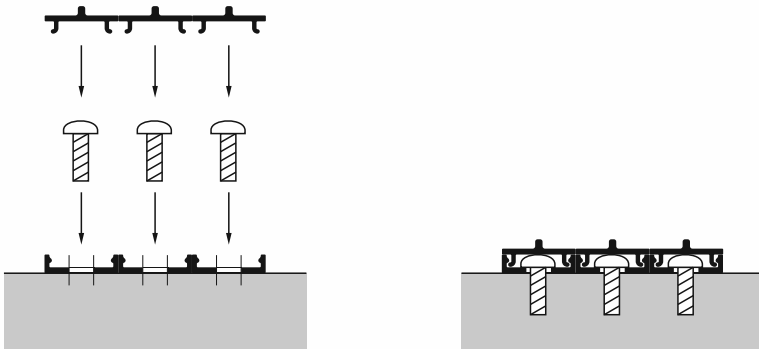

Set of side tracks E and D.

DiE

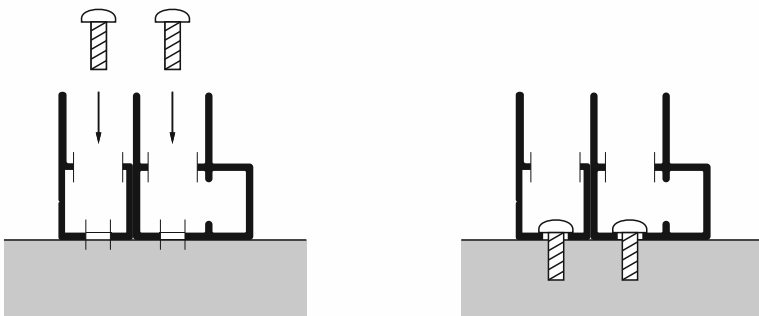

Assembling side tracks and corners.

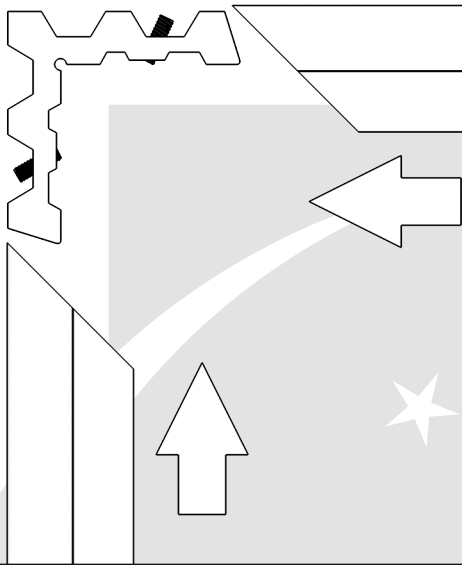

Tighten screws in the corners with using 2,5 mm key.

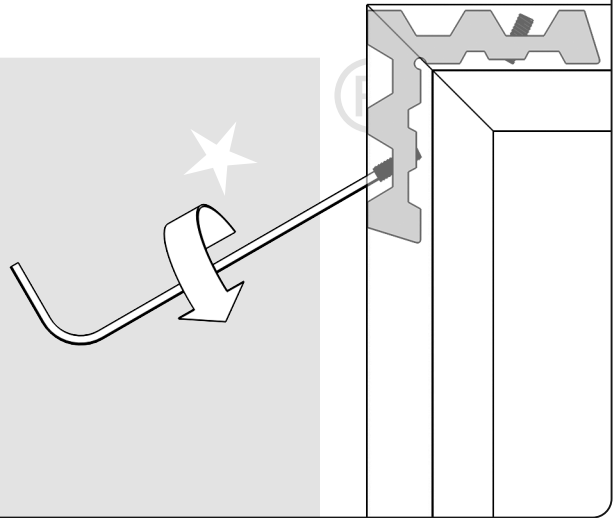

Fastening frame in the side tracks.

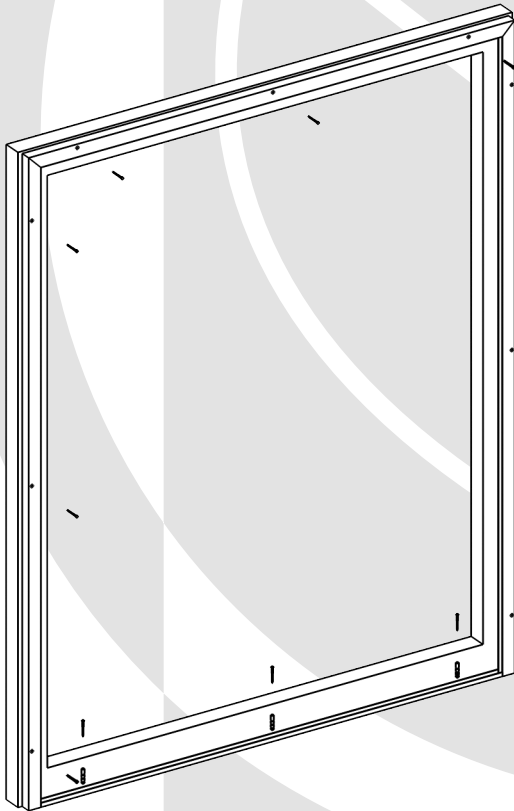

Installing hole caps.

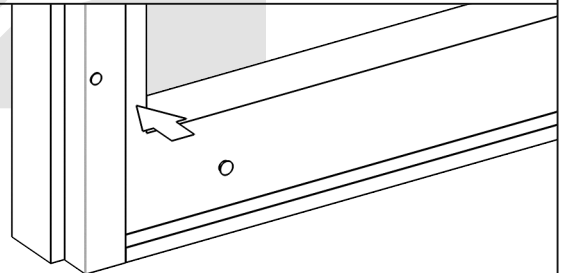
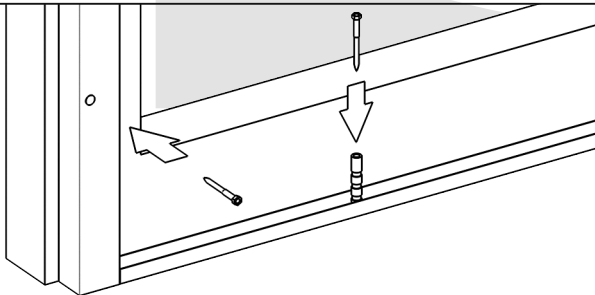
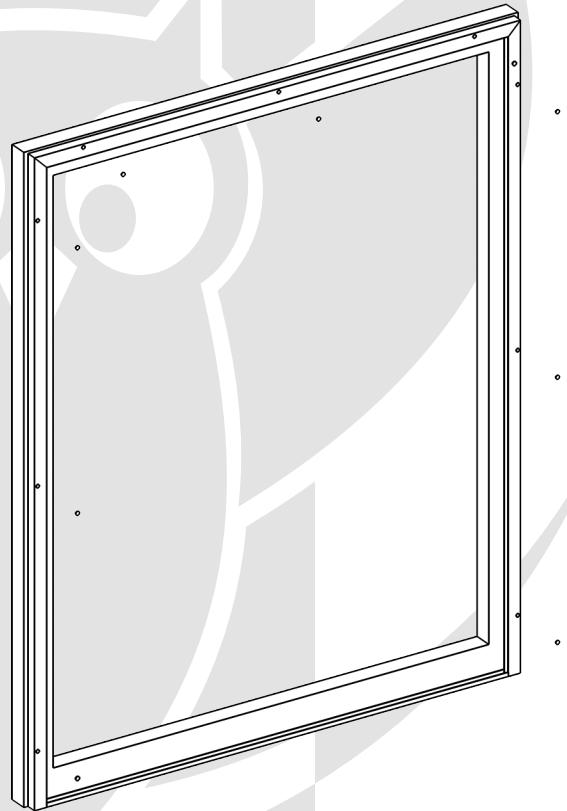

Installing insect screen.

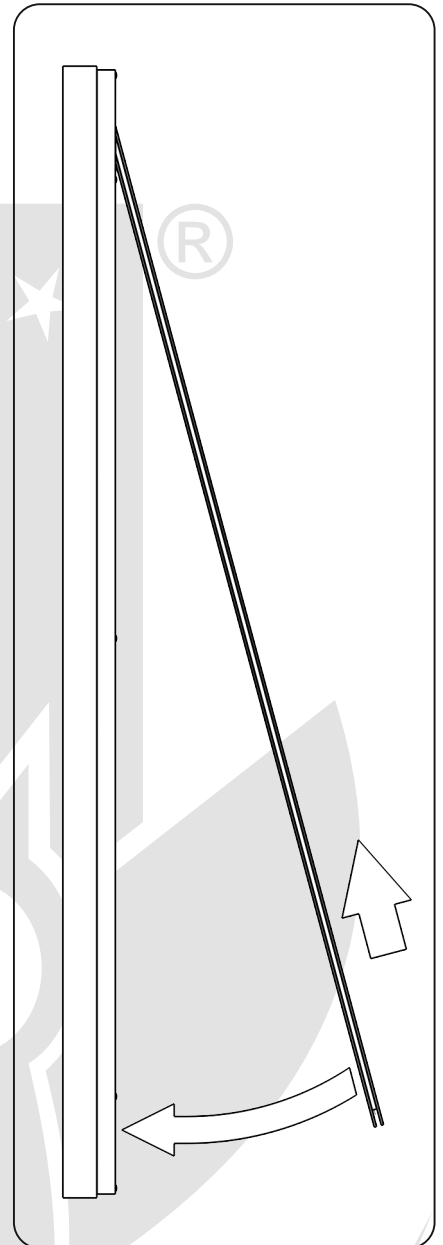
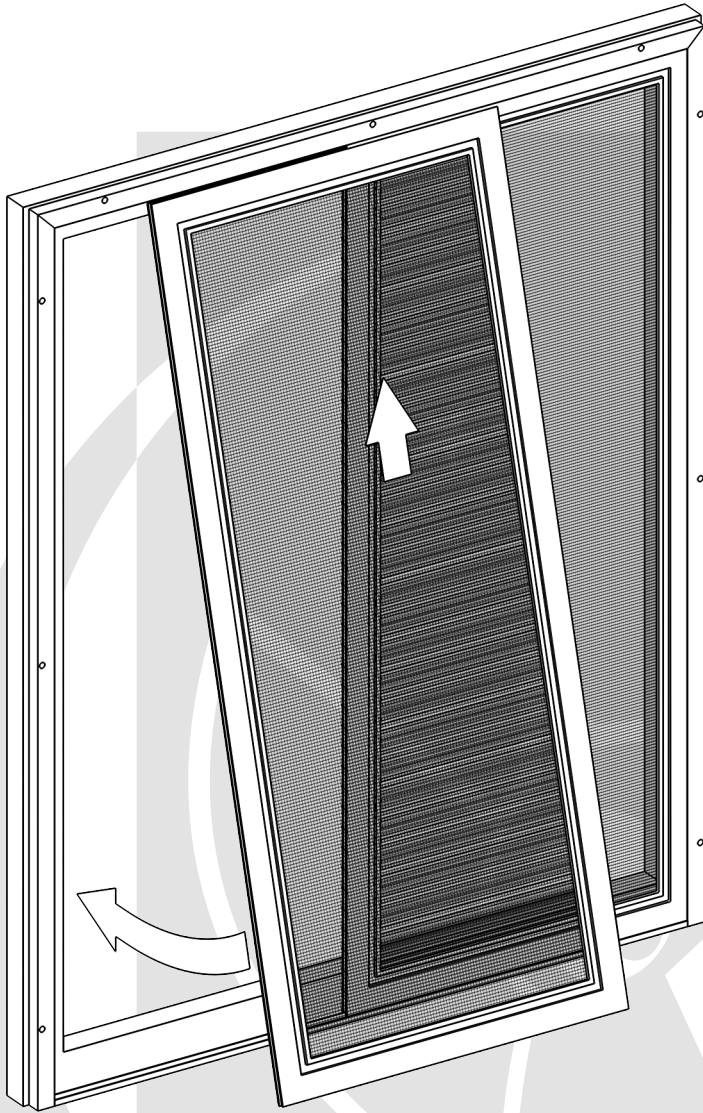

Locking insect screen.

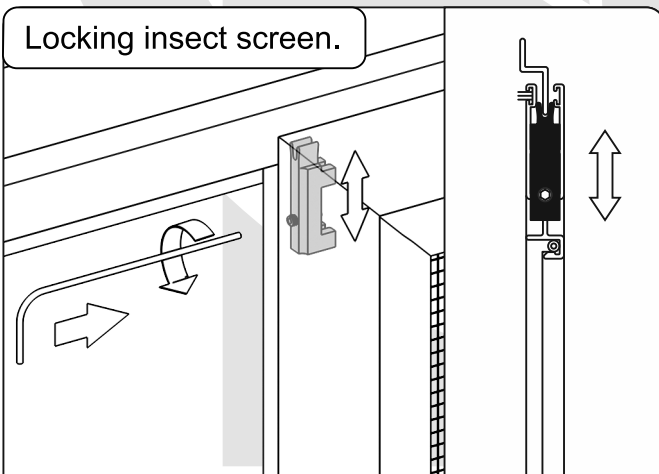

Lock the insect screen in side tracks using guide element (in top and bottom section of the frame). Keep minimum clearance in relation to the track.

Levelling insect screen.

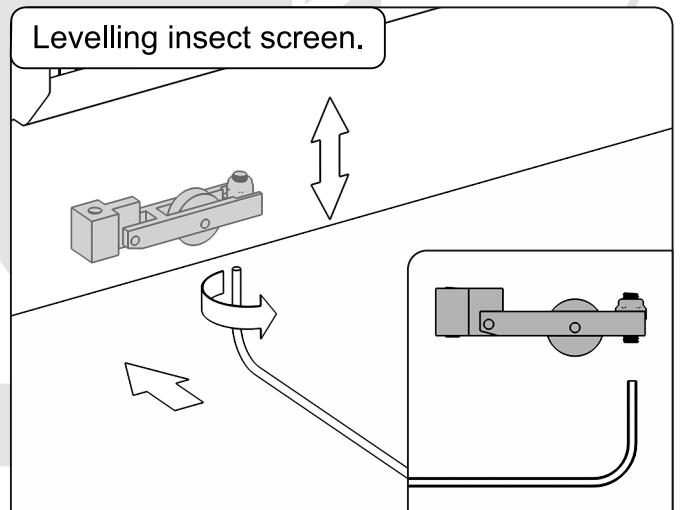

The insect screen inclination is adjusted with a set screw in the track roller with using 2 mm key.



Fart Produkt Sp. z o. o. Sp. k.
ul. Towarowa 3, 87-100 Toruń
tel. +48 56 623 55 77
e-mail: export@fartprodukt.pl
www.fartprodukt.pl