

Garage
doors

Sectional garage door price list



Issue 15.05.2023

CONTENTS

01 - 20	GARAGE DOORS
21 - 26	INDUSTRIAL DOORS
27 - 29	DOOR ORDER
30	GENERAL TERMS OF SALE

General

Fart Produkt garage doors are for use in single and multi-unit residential buildings. Sectional garage doors open vertically and remain under the ceiling for optimum parking space inside and in front of the garage. Our doors can be installed with min. 70 mm headroom. The doors can be operated manually with handle and cord or optional - with an electric drive. The door panel design and durable seal at its entire circumference provide excellent thermal insulation.

Door design

The main elements of the garage door structure are: armor, load-bearing structure and drive unit. The door frame is made of hot galvanized steel. Horizontal and vertical tracks are the main components for door curtain movement. The main drive unit component is a shaft with torsion springs, which compensate the door curtain weight. The torsion springs guarantee 15 thousand cycles of operation, i.e. 15 years of failure-free and reliable operation.





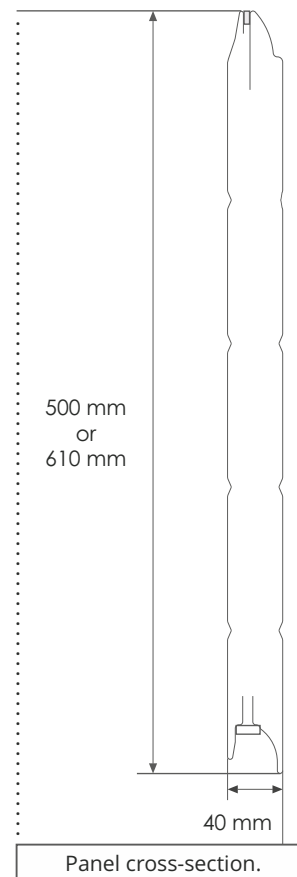

Door curtain

The door curtain is divided on sections of several panels made of hot-dip galvanized 0.5 mm steel sheet and coated with polyester. Dihedral 40mm wide panels, 500 mm or 610 mm high are insulated with CFC-free polyurethane foam and their sides are secured with fittings made of galvanized sheet. The height and number of panels depends on door height, and different height panels can be used in one door. Special panel profile is protecting fingers from crushing between the door sections. Top and bottom panels are fitted with a seal.



Panels

The panels are available in three versions: without ribbing, high profile ribbing or low profile ribbing and two surface finishes: woodgrain and smooth. Door panels are painted from without and always white from within. Standard colours: white (RAL 9010), brown (RAL 8014) or anthracite (RAL 7016). Other colours are available at extra cost.

RIBBING TYPE	COLOUR	WOODGRAIN	SMOOTH	SURCHARGE
LOW RIBS  	white RAL 9010	✓	—	—
	brown RAL 8014	✓	—	
	anthracite 7016	✓	—	
	swamp oak	✓	—	18%
	walnut mahogany golden oak	✓ ✓ ✓	— — —	
HIGH RIBS  	white RAL 9010	✓	—	—
	brown RAL 8014	✓	—	
	anthracite 7016	✓	—	
	swamp oak	—	✓	18%
	walnut winchester golden oak	— — —	✓ ✓ ✓	
NO RIBS  	white RAL 9010	—	✓	—
	gray RAL 7040	—	✓	5%
	black RAL 9005	—	✓	22%
	anthracite	—	✓	
	anthracite micro groove	—	✓	24%
	woodec turner oak black RAL 9005 matt	— —	✓ ✓	
	anthracite sandgrain	—	✓	18%
	anthracite satin	—	✓	
	walnut	—	✓	
	winchester	—	✓	
goldean oak	—	✓		
	other RAL colours	25,50 €/m ²	57,25 €/m ² (only matt) *	—

All prices are net in EUR, the tax needs to be added.







* prior consultation with the manufacturer is required.

Standard configuration of door curtain panels

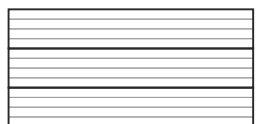
Different height panels (500 mm or 610 mm) can be used depending on the door height. The table shows standard configuration of Fart Produkt sectional garage door curtain.

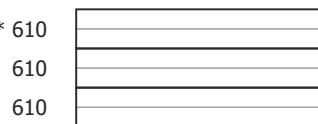
If other panel configuration/layout required, it needs to be indicated in the order form.

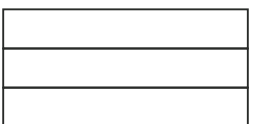
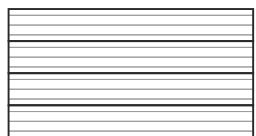
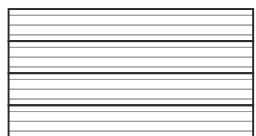
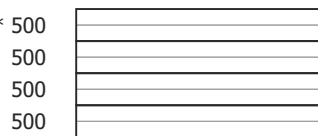
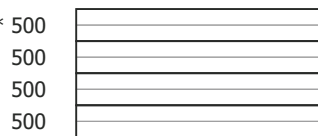
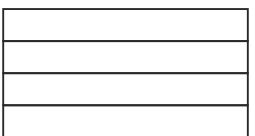
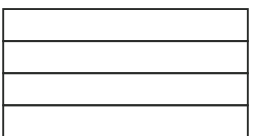
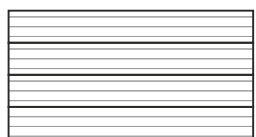
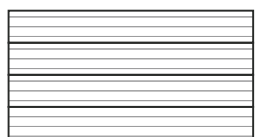
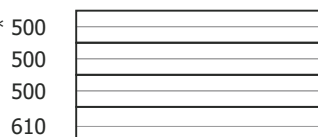
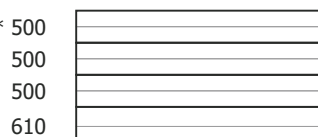
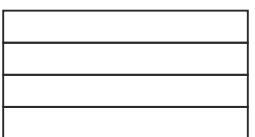
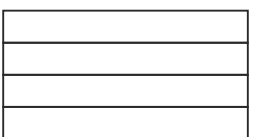
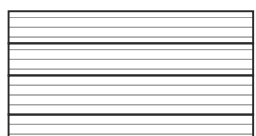
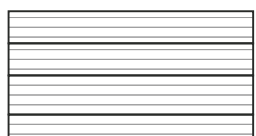
PANEL HEIGHT IN STANDARD DOOR CURTAIN CONFIGURATION

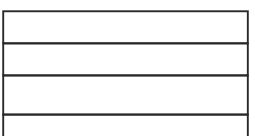
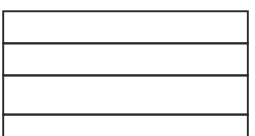
DOOR HEIGHT	LOW RIBS	HIGH RIBS	NO RIBS
up to 1850 * up to 1850, 610 cut from the top	 * 610  610 610	 * 610  610 610	 * 610  610 610
1860 - 2020 * up to 2020, 500 cut from the top	 * 500  500 500 500	 * 500  500 500 500	 * 500  500 500 500
2030 - 2130 * up to 2130, 500 cut from the top	 * 500  500 500 610	 * 500  500 500 610	 * 500  500 500 610
2140 - 2240 * up to 2240, 500 cut from the top ** up to 2240, 610 cut from the top	 * 500  500 610 610	 ** 610  610 610 610	 * 500  500 610 610











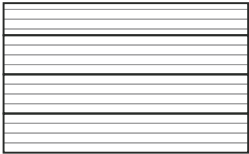
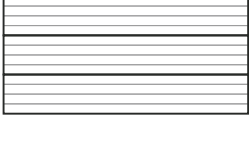
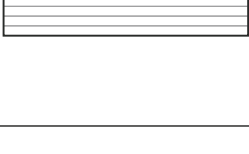
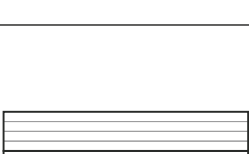
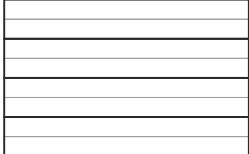
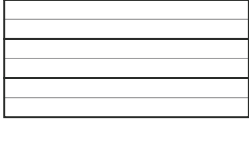
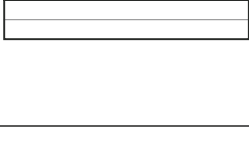
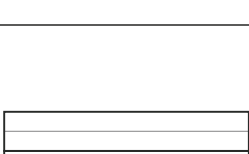
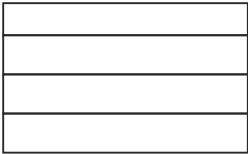
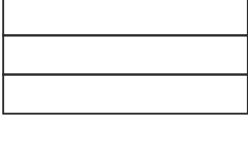
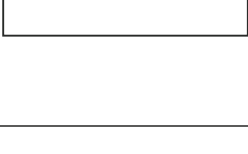
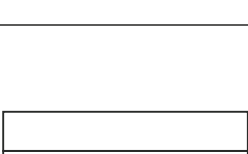
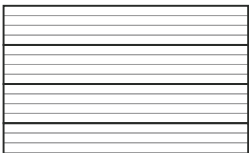
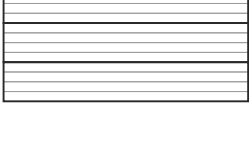

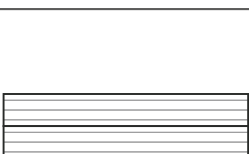
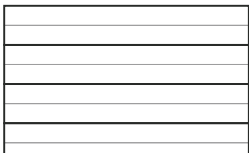
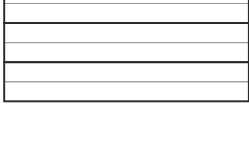
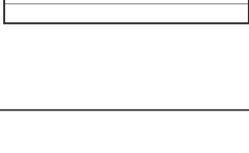
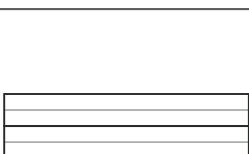
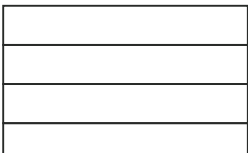
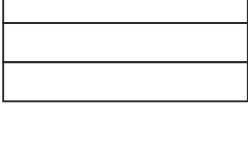
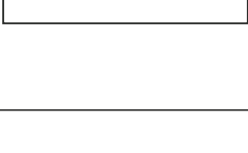
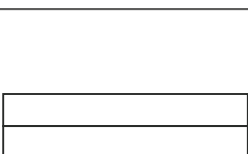
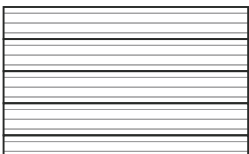
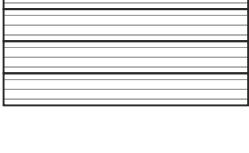

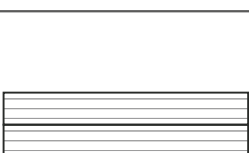
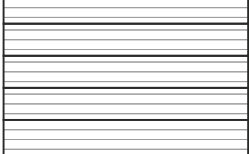
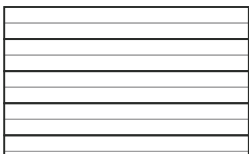
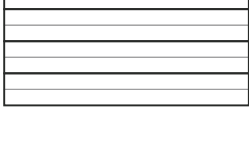
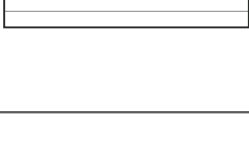
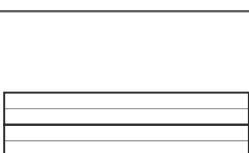
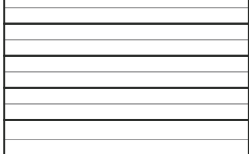
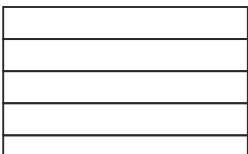
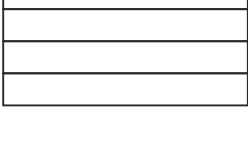
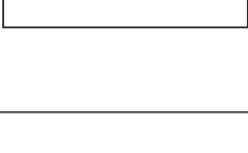
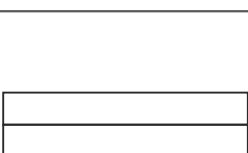
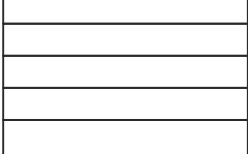
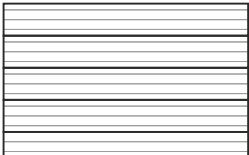
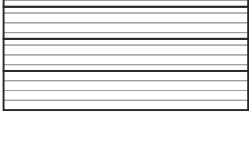
Standard configuration of door curtain panels

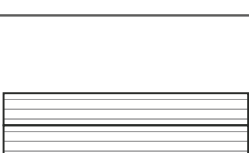
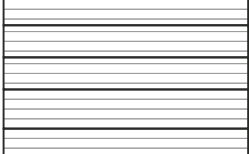
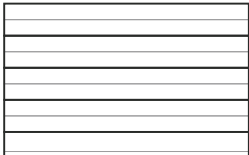
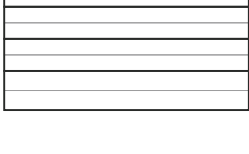
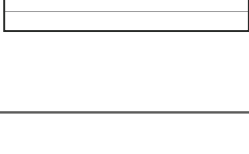
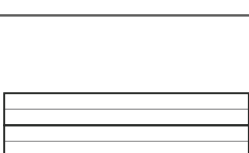
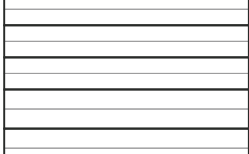
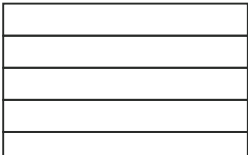
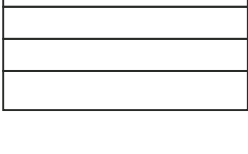
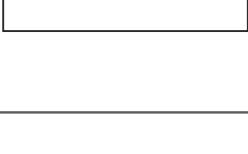
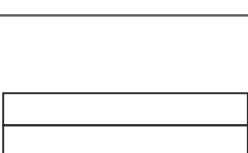
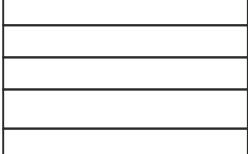
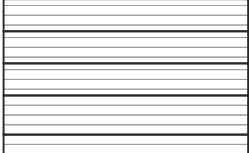
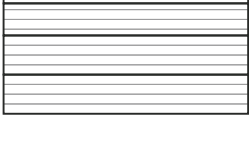
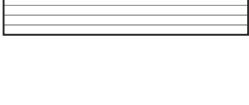
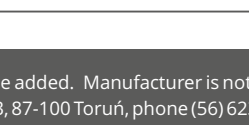
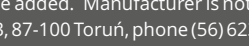
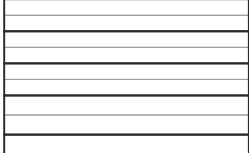
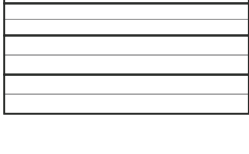
Different height panels (500 mm or 610 mm) can be used depending on the door height. The table shows standard configuration of Fart Produkt sectional garage door curtain.

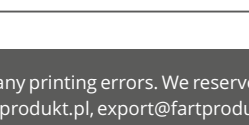
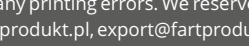
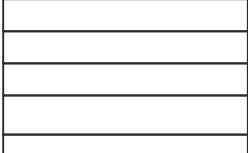
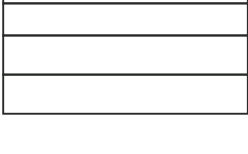
If other panel configuration/layout required, it needs to be indicated in the order form.

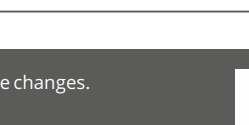
PANEL HEIGHT IN STANDARD DOOR CURTAIN CONFIGURATION

<p>2250 - 2350 * up to 2350, 500 cut from the top ** up to 2350, 610 cut from the top</p>	<p>* 500 </p> <p>610 </p> <p>610 </p> <p>610 </p>	<p>** 610 </p> <p>610 </p> <p>610 </p> <p>610 </p>	<p>* 500 </p> <p>610 </p> <p>610 </p> <p>610 </p>
<p>2360 - 2460 * up to 2460, 610 cut from the top</p>	<p>* 610 </p> <p>610 </p> <p>610 </p> <p>610 </p>	<p>* 610 </p> <p>610 </p> <p>610 </p> <p>610 </p>	<p>* 610 </p> <p>610 </p> <p>610 </p> <p>610 </p>
<p>2470 - 2520 * up to 2520, 500 cut from the top</p>	<p>* 500 </p> <p>500 </p> <p>500 </p> <p>500 </p> <p>500 </p>	<p>* 500 </p> <p>500 </p> <p>500 </p> <p>500 </p> <p>500 </p>	<p>* 500 </p> <p>500 </p> <p>500 </p> <p>500 </p> <p>500 </p>
<p>2530 - 2630 * up to 2630, 500 cut from the top</p>	<p>* 500 </p> <p>500 </p> <p>500 </p> <p>500 </p> <p>610 </p>	<p>* 500 </p> <p>500 </p> <p>500 </p> <p>500 </p> <p>610 </p>	<p>* 500 </p> <p>500 </p> <p>500 </p> <p>500 </p> <p>610 </p>
<p>2630 - 2750 * up to 2750, 500 cut from the top</p>	<p>* 500 </p> <p>500 </p> <p>500 </p> <p>610 </p> <p>610 </p>	<p>* 500 </p> <p>500 </p> <p>500 </p> <p>610 </p> <p>610 </p>	<p>* 500 </p> <p>500 </p> <p>500 </p> <p>610 </p> <p>610 </p>



Track types

Sectional garage doors are available in 5 track types:

TRACK TYPE	MINIMUM HEADROOM	
	MANUAL	ELECTRIC DRIVE
HOME-X	90 mm	120 mm
RSC	200 mm	240 mm
STANDARD	300 mm	340 mm
LHR+	200 mm	240mm
RES 70	70 mm	110 mm

Automatics

For those who place importance on comfort, we offer garage doors with electric drive, which are compatible with all door types, and are selected depending on the garage door size, weight, frequency of usage and materials of which it is made. Minimum headroom for garage doors with electric drive increases by **40 mm**.

Required minimum garage depth for garage doors with electric drive.

3160 mm* – short track
3760 mm** – long track

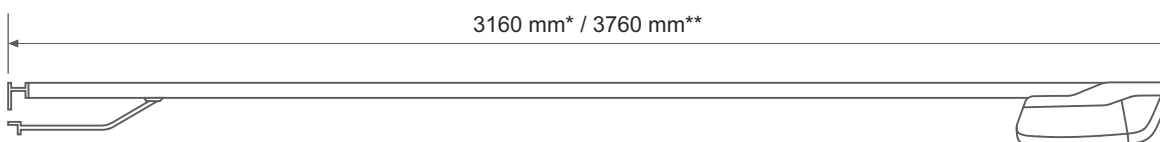

SOMFY

SOMFY ELECTRIC GARAGE DOOR DRIVE PRICES	
DRIVE TYPE	PRICE
SOMFY OPTIMO 800N up to 11 m ² max width 4500 mm	272 €
SOMFY OPTIMO 800N io up to 11 m ² max width 4500 mm (available only with SOMFY Keygo io remote control)	410 €
SOMFY DEXXO PRO 1000N up to 13 m ²	353 €
SOMFY DEXXO PRO io 1000N up to 13 m ² (available only with SOMFY Keygo io remote control)	492 €

- SOMFY DRIVE ACCESSORIES**
- Drive head with receiver.
 - Track 3000 mm with chain (max. door height 2300 mm)
 - 1 **Somfy** 2-channel RTS remote control with dynamically variable code.

- SOMFY OPTIONAL ACCESSORIES - ELECTRIC DRIVES AT EXTRA COST**
- Surcharge for track with strap 39,00 €
 - Surcharge for 3500mm track with chain (max. door height 2900 mm)..... 16,50 €
 - 2-channel remote control SOMFY 22,50 €
 - 4-channel remote control SOMFY 23,50 €
 - Remote control SOMFY Keygo 30,00 €
 - Remote control SOMFY Keygo io 40,00 €
 - Photocell SOMFY 50,00 €/set
 - Emergency release SOMFY..... 37,50 €
 - Motor battery Somfy OPTIMO 25,75 €
 - Universal radio receiver FART with 4-channel remote control 55,00 €

All prices are net in EUR, the tax needs to be added.



BFT

BFT ELECTRIC GARAGE DOOR DRIVE PRICES

DRIVE TYPE	PRICE
BFT BOTTICELLI 650 up to 9 m ²	240 €
BFT BOTTICELLI 850 SMART up to 11 m ²	263 €
BFT BOTTICELLI 1250 SMART up to 15 m ²	399 €

BFT DRIVE ACCESSORIES

- Drive head with receiver.
- Track 3000 mm with chain (max. door height 2300 mm)
- 1 **BFT** 2-channel remote control with dynamically variable code.

BFT OPTIONAL ACCESSORIES - ELECTRIC DRIVES AT EXTRA COST

- Surcharge for track with strap 39,00 €
- Surcharge for 3500mm track with chain (max. door height 2900 mm) 16,50 €
- 2-channel remote control BFT..... 16,50 €
- 4-channel remote control BFT..... 22,50 €
- Photocell BFT 50,00 €/set
- Emergency release BFT..... 37,50 €
- Universal radio receiver FART with 4-channel remote control..... 55,00 €
- **BFT B-EBA Wi-Fi Gateway module** 179,50 €

(**BFT B-EBA Wi-Fi Gateway** - allows controlling the garage doors via smartphone with feedback showing gate position. Available with BFT BOTTICELLI 850 SMART and BFT BOTTICELLI 1250 SMART motors).

All prices are net in EUR, the tax needs to be added.

SOMMER

SOMMER ELECTRIC GARAGE DOOR DRIVE PRICES

DRIVE TYPE	PRICE
SOMMER Aperto light 550 up to 8 m ² (short track)	225 €
SOMMER Aperto light 800 up to 12 m ² (short track)	263 €
SOMMER Aperto 550 L light up to 8 m ² (long track)	250 €
SOMMER Aperto 800 XL light up to 12 m ² (long track)	288 €

SOMMER DRIVE ACCESSORIES

- Drive head with receiver.
- Short or long rail with chain. Short rail up to a maximum garage door height of 2300 mm, long rail up to a maximum garage door height of 3100 mm.
- 2 SOMMER 2-channel remote controls with dynamically changful code.
- Mural switch-button.

SOMMER OPTIONAL ACCESSORIES - ELECTRIC DRIVES AT EXTRA COST

- 2-channel remote control SOMMER 21,25 €
- 4-channel remote control SOMMER 27,50 €
- Emergency release SOMMER 21,25 €
- 700 mm elongated push arm (for standard tracking type). 17,50 €
- Photocell SOMMER 45,00 €/set
- Wicket opening sensor..... 47,50 €

All prices are net in EUR, the tax needs to be added.

Optional accessories

Perforated angle section for support L=2000 mm	10,25 €/pc.
Inner bolt	9,75 €/pc.
Lock	56,50 €/pc.
Rectangular window (external frame dimensions 630 mm x 330 mm)	47,50 €/pc.
Floor bracket - pair (Fig. 3)	6,50 €/pair
Shaft cap	1,83 €/pc.
Floor section (Fig. 4)	10,75 €/m
Floor seal 18 metres	38,00 €/18 m
Plastic gable vent (black / white) 344 mm x 138 mm	27,50 €/pc.
Aluminium gable vent (varnished on RAL colour) 600 mm x 300 mm	93,25 €/pc.
Glass-panelled section in aluminium frame (frame - anodized aluminium)	111,25 €/m
Glass-panelled section in aluminium frame (frame in RAL colour)	155,00 €/m
NEW! Ventilated panel section in aluminium frame (frame - anodized aluminium)	117,00 €/m
NEW! Ventilated panel section in aluminium frame (frame in RAL colour)	156,00 €/m
NEW! Quiet roll bracket – 8 pc. set for 4-panels garage door with a max width of 4460 mm	12,25 €/8 pc.
NEW! Wicket in the SAFESTEP system*	787,50 €/pc.
NEW! Two-lip seal of the top panel (Fig. 1.)	6,50 €/m
NEW! Side / top thermal seal (Fig. 2.)	5,00 €/m

All prices are net in EUR, the tax needs to be added.

NEW! Fig. 1. 2-LIP SEAL

A high-quality 2-lip top seal provides increased insulation between the top panel and the headroom.

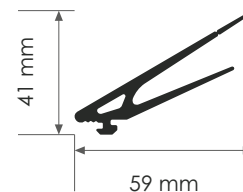

NEW! Fig. 2. THERMAL SEAL

The profile with the double function of the side and top gas-kets prevents the formation of thermal bridges, increasing the thermal insulation properties of the garage door.

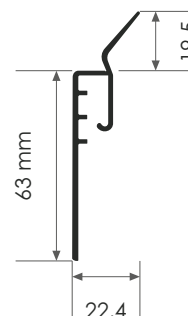

Optional accessories

Fig. 3. FLOOR BRACKET - PAIR

Floor bracket for attaching the vertical tracks to the floor for improved burglar-proofing.

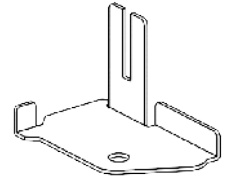
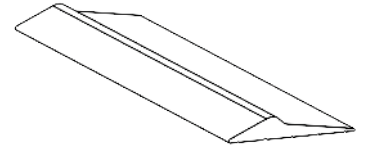

Fig. 4. FLOOR SECTION

Rubber seal for improved tightness between the floor and the door curtain. The seal prevents water from entering the garage. Attached to the floor with glue (not included).



NEW! QUIET ROLL BRACKET

The new roll bracket with a soundproofing system ensures smooth and silent sliding of the rollers in the hinges (maximum gate width is 4460 mm).



NEW! SAFESTEP

The SAFESTEP wicket is a convenient crossing for pedestrians. Integrated with the structure, invisible hinges give the gate an aesthetic appearance, and the low threshold makes the wicket comfortable. Using it, there is no need to open the entire sectional gate to get inside the building. The wicket in the gate allows for a significant reduction of energy losses.

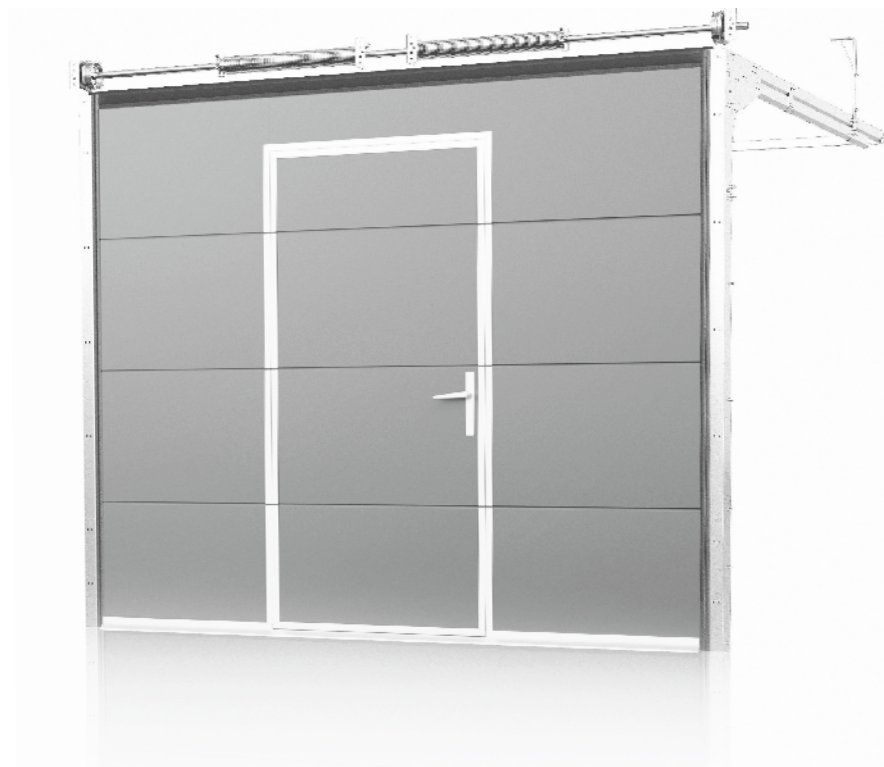

***Note** - in garage doors wider than 4000 mm, the wicket can be placed only in the middle of the garage door.

"HOME-X" tracks

- HOME-X gates - an innovative version of gates with extension springs placed on vertical guides.
- Min.headroom is **90 mm**, min. sideroom width **100 mm**.

Minimum installation dimensions

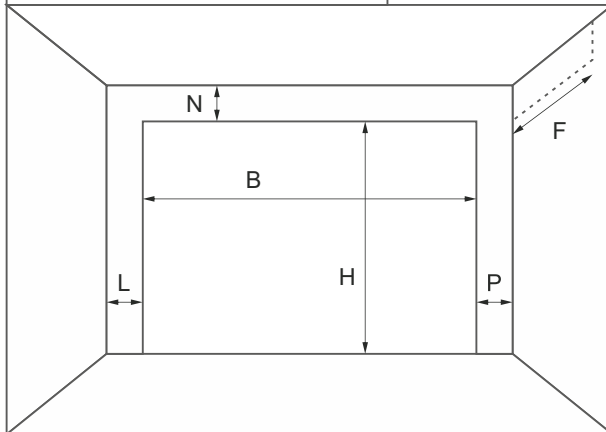

B	opening width
H	opening height
N	headroom
L, P	sideroom width
F	horizontal track installation depth
*	door with motor

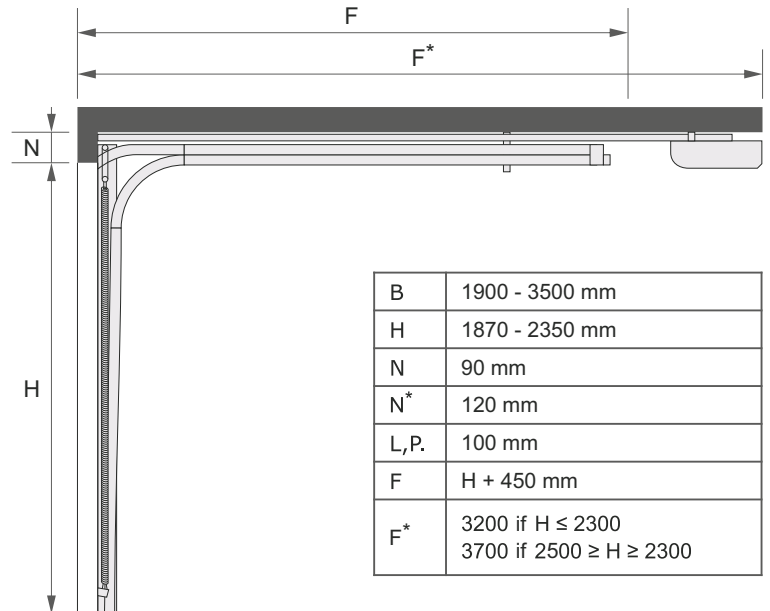

B	1900 - 3500 mm
H	1870 - 2350 mm
N	90 mm
N*	120 mm
L, P.	100 mm
F	H + 450 mm
F*	3200 if H ≤ 2300 3700 if 2500 ≥ H ≥ 2300

☰ No Surcharge – FPGP panel with horizontal low ribbing in woodgrain structure, colours: white 9010, brown 8014, anthracite 7016.							
up to	2250	2500	2750	3000	3250	3500	Door sections
2000	666	684	758	827	878	904	4
2125	684	695	791	835	979	959	4
2240	725	736	831	883	930	1011	4
2350	746	772	864	919	1081	1146	4
Max. no. of windows in section	2			3			

All prices are net in EUR, the tax needs to be added.

☐ ☐ No Surcharge – FPGG panel without ribbing in smooth structure – white 9010. No Surcharge – FPGS panel with high ribbing in woodgrain structure – white 9010, brown 8014, anthracite 7016.							
up to	2250	2500	2750	3000	3250	3500	Door sections
2000	743	784	827	864	901	937	4
2125	758	808	839	952	981	1011	4
2240	817	827	945	989	1040	1092	4
2350	853	872	996	1048	1125	1202	4
Max. no. of windows in section	2			3			

All prices are net in EUR, the tax needs to be added.

- Net price per set – ex VAT.
- Standard, included in the price: inner bolt from the right side, from the inside.
- Please check width availability before ordering.



"HOME-X" tracks

Surcharge. FPGP panel with horizontal low ribbing in woodgrain structure, colours at extra charge – swamp oak, walnut, mahogany, golden oak – 18%.							
up to	2250	2500	2750	3000	3250	3500	Door sections
2000	666	684	758	827	878	904	4
2125	684	695	791	835	979	959	4
2240	725	736	831	883	930	1011	4
2350	746	772	864	919	1081	1146	4
Max. no. of windows in section	2			3			

All prices are net in EUR, the tax needs to be added.

Surcharge. FPGG panel without ribbing in smooth structure – anthracite sandgrain, anthracite satin, walnut, winchester, golden oak 18%, colours at extra charge: – anthracite 22%, anthracite micro-groove, woodec turner oak, black RAL 9005 matt 24%.							
Surcharge. FPGSG panel with high ribbing in smooth structure, colours at extra charge – swamp oak, walnut, winchester, golden oak – 18%.							
up to	2250	2500	2750	3000	3250	3500	Door sections
2000	743	784	827	864	901	937	4
2125	758	808	839	952	981	1011	4
2240	817	827	945	989	1040	1092	4
2350	853	872	996	1048	1125	1202	4
Max. no. of windows in section	2			3			

All prices are net in EUR, the tax needs to be added.

Surcharge. FPGG panel without ribbing in smooth structure, colours at extra charge – gray RAL 7040, black RAL 9005 5%.							
up to	2250	2500	2750	3000	3250	3500	Door sections
2000	743	784	827	864	901	937	4
2125	758	808	839	952	981	1011	4
2240	817	827	945	989	1040	1092	4
2350	853	872	996	1048	1125	1202	4
Max. no. of windows in section	2			3			

All prices are net in EUR, the tax needs to be added.

- Net price per set – ex VAT.
- Standard, included in the price: inner bolt from the right side, from the inside.
- Please check width availability before ordering.
- **Surcharge:** – gray RAL 7040, black RAL 9005 – **5%**
 - Golden oak, walnut, mahogany, swamp oak, anthracite sandgrain, anthracite satin, Winchester – **18%**,
 - anthracite – **22%**,
 - black RAL 9005 matt, anthracite micro grove, woodec turner oak – **24%**.

HOME-0 installation set

- : HOME-0 installation set-a solution that allows you to install the HOME-X system garage door as a built-in garage door in a place without a headroom or side rooms.

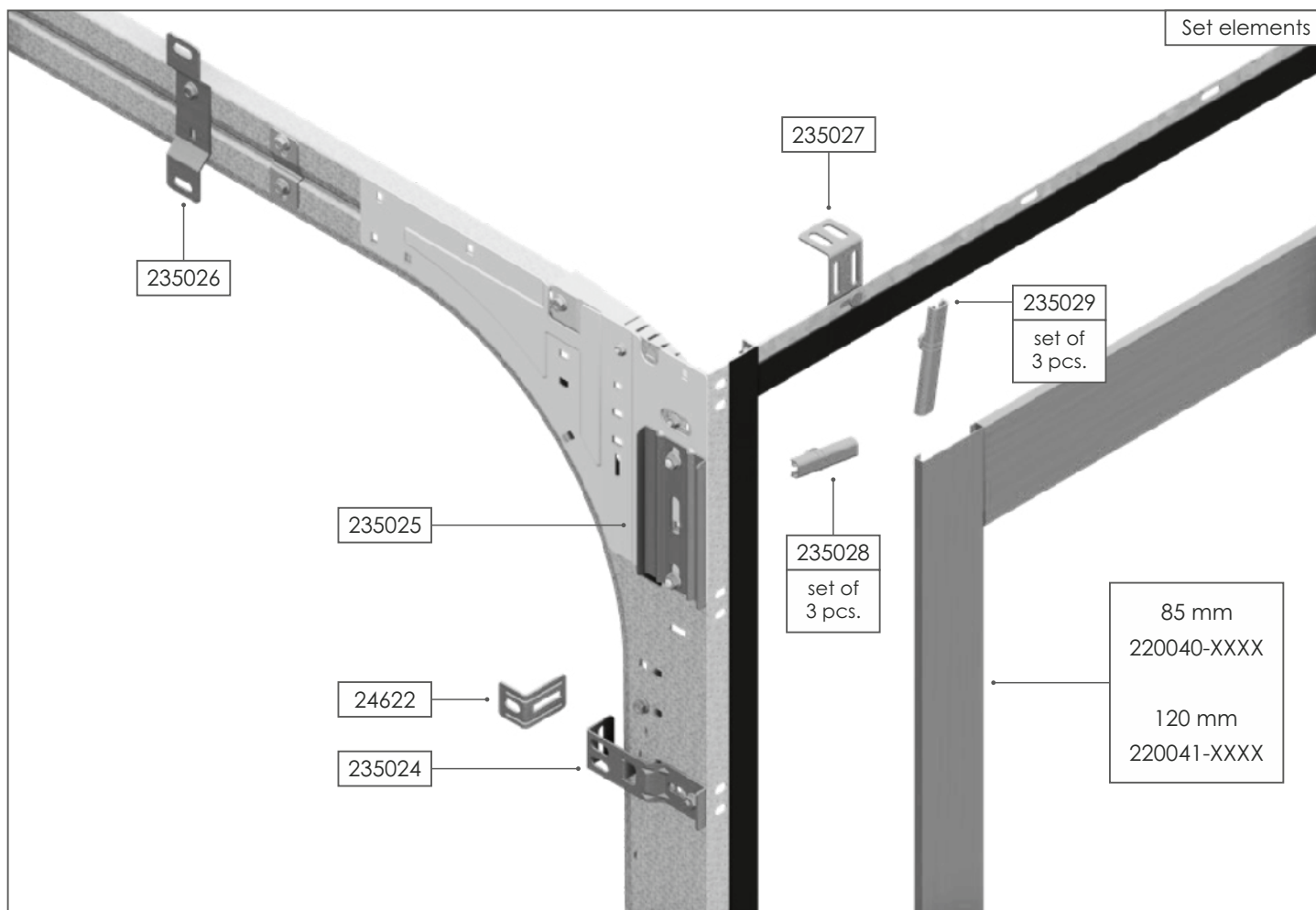

PRICE LIST OF HOME-0 ELEMENTS

■ 220040 - RAL 7016, 3000 mm	73,00 €
■ 220040 - RAL 9016, 3000 mm	49,00 €
■ 220041- RAL 7016, 3000 mm	75,50 €
■ 220041- RAL 9016, 3000 mm	74,50 €
■ 235024	1,75 €
■ 235025	2,15 €
■ 235026	1,50 €
■ 235027	1,40 €
■ 235028 (set of 3 pcs.)	25,80 €
■ 235029 (set of 3 pcs.)	30,20 €

235024 - number of items to order

height of the opening ≤ 2250	x 4
2250 < height of the opening ≤ 2750	x 5
2750 < height of the opening ≤ 3000	x 7

L+R

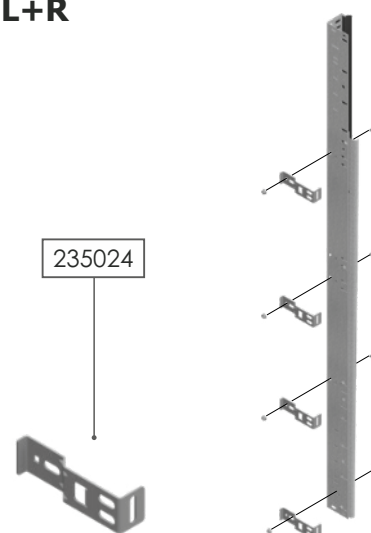

235026 - number of items to order

height of the opening ≤ 2250	Y
$2250 <$ height of the opening ≤ 3000	Y+Z

L+R

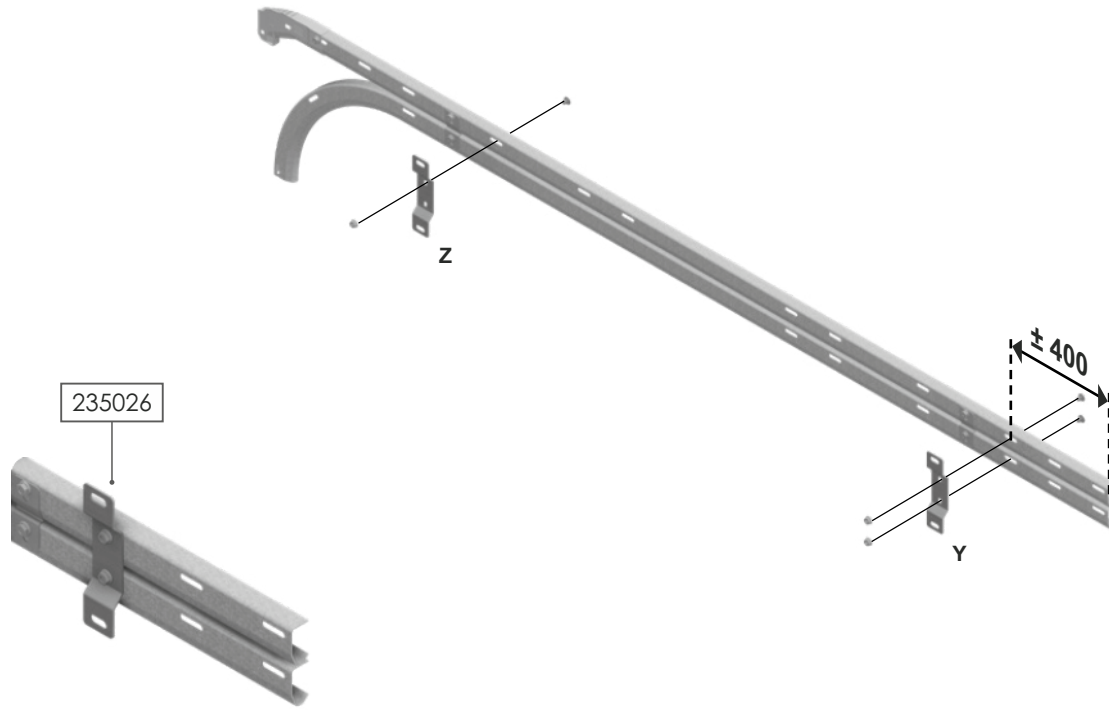

235027 - number of items to order

width of the opening ≤ 2000	x3
$2000 <$ width of the opening ≤ 2500	x4
$2500 <$ width of the opening ≤ 3000	x5

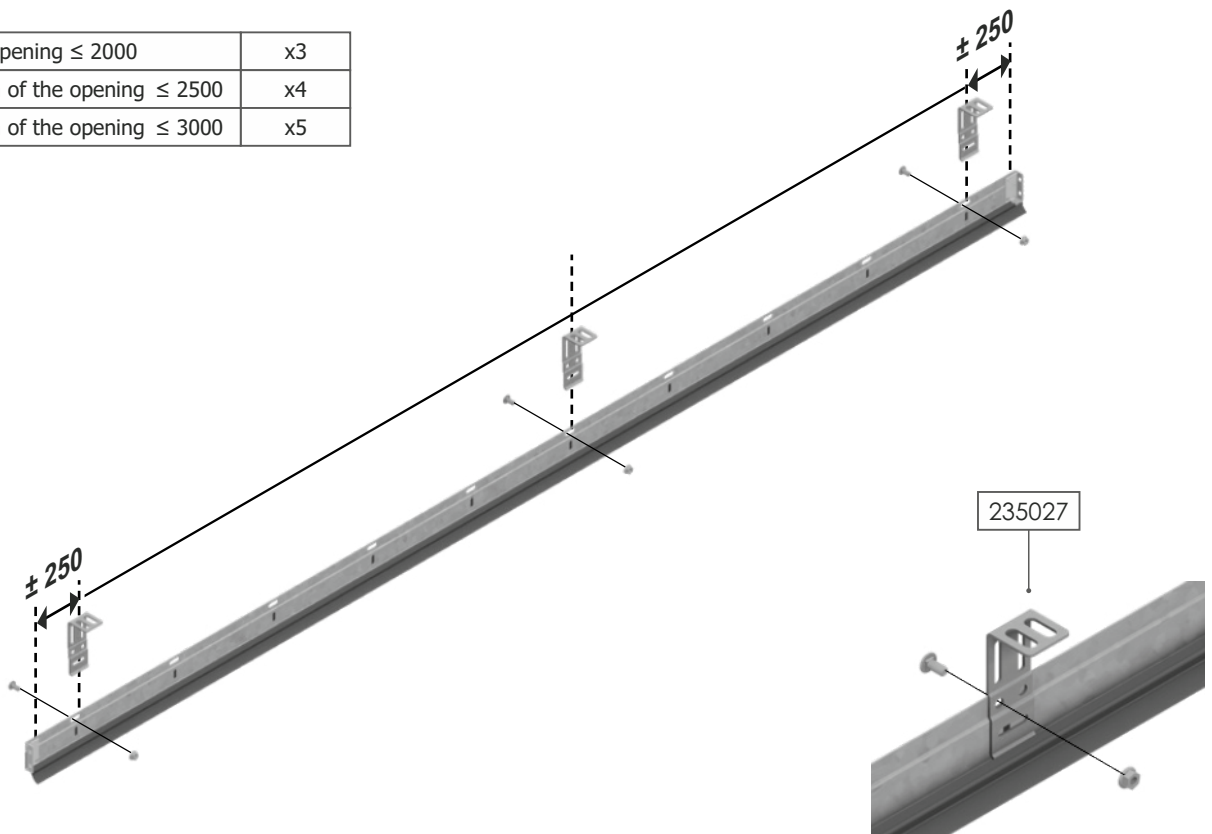

Sectional garage door price list



"RSC" tracks

: RSC Garage doors - is an innovative version of LHR type garage doors. Min.headroom is **200 mm**, min. sideroom width **100 mm**.

Minimum installation dimensions

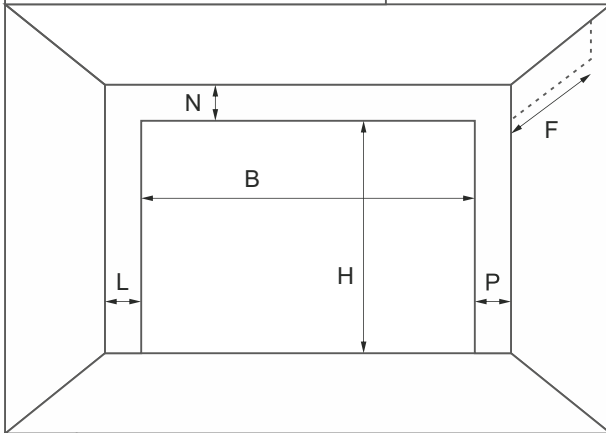

B	opening width
H	opening height
N	headroom
L, P	sideroom width
F	horizontal track installation depth
*	door with motor

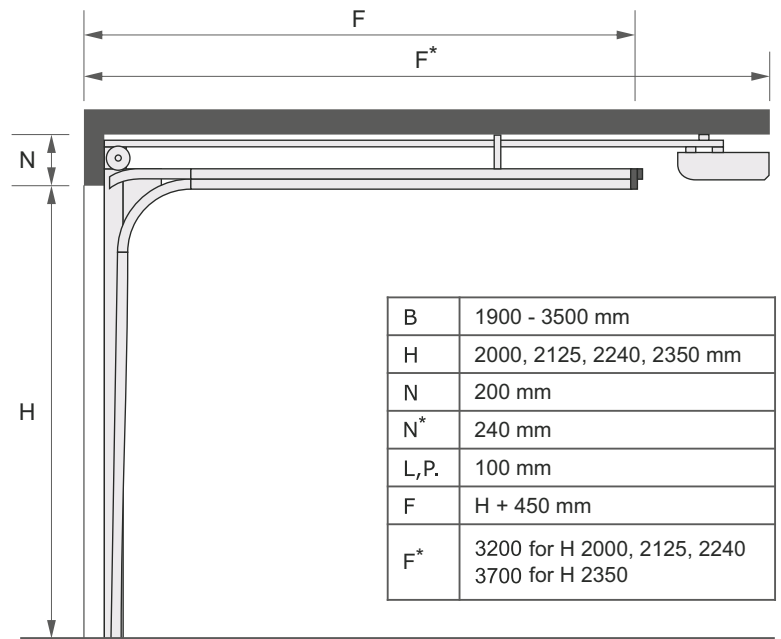

B	1900 - 3500 mm
H	2000, 2125, 2240, 2350 mm
N	200 mm
N*	240 mm
L, P.	100 mm
F	H + 450 mm
F*	3200 for H 2000, 2125, 2240 3700 for H 2350

No Surcharge – FPGP panel with horizontal low ribbing in woodgrain structure, colours: white 9010, brown 8014, anthracite 7016.

up to	2250	2500	2750	3000	3250	3500	Door sections
2000	701	720	798	871	924	951	4
2125	720	732	833	879	979	1010	4
2240	763	775	875	929	1006	1064	4
2350	786	813	910	968	1137	1207	4
Max. no. of windows in section	2			3			

All prices are net in EUR, the tax needs to be added.

No Surcharge – FPGG panel without ribbing in smooth structure – white 9010.
No Surcharge – FPGS panel with high ribbing in woodgrain structure – white 9010, brown 8014, anthracite 7016.

up to	2250	2500	2750	3000	3250	3500	Door sections
2000	782	825	871	910	948	987	4
2125	798	828	883	1002	1033	1064	4
2240	860	871	995	1041	1095	1149	4
2350	898	918	1048	1103	1184	1265	4
Max. no. of windows in section	2			3			

All prices are net in EUR, the tax needs to be added.

- Net price per set – ex VAT.
- Standard, included in the price: inner bolt from the right side, from the inside.
- Please check width availability before ordering.

"RSC" tracks

 Surcharge.

FPGP panel with horizontal low ribbing in woodgrain structure, colours at extra charge – swamp oak, walnut, mahogany, golden oak – 18%.

up to	2250	2500	2750	3000	3250	3500	Door sections
2000	701	720	798	871	924	951	4
2125	720	732	833	879	979	1010	4
2240	763	775	875	929	1006	1064	4
2350	786	813	910	968	1137	1207	4
Max. no. of windows in section	2			3			

All prices are net in EUR, the tax needs to be added.

 Surcharge. FPGG panel without ribbing in smooth structure – anthracite sandgrain, anthracite satin, walnut, winchester, golden oak 18%, colours at extra charge: – anthracite 22%, anthracite micro-groove, woodec turner oak, black RAL 9005 matt 24%.

 Surcharge.

FPGSG panel with high ribbing in smooth structure, colours at extra charge – swamp oak, walnut, winchester, golden oak – 18%.

up to	2250	2500	2750	3000	3250	3500	Door sections
2000	782	825	871	910	948	987	4
2125	798	828	883	1002	1033	1064	4
2240	860	871	995	1041	1095	1149	4
2350	898	918	1048	1103	1184	1265	4
Max. no. of windows in section	2			3			

All prices are net in EUR, the tax needs to be added.

 Surcharge. FPGG panel without ribbing in smooth structure, colours at extra charge – gray RAL 7040, black RAL 9005 5%.

up to	2250	2500	2750	3000	3250	3500	Door sections
2000	782	825	871	910	948	987	4
2125	798	828	883	1002	1033	1064	4
2240	860	871	995	1041	1095	1149	4
2350	898	918	1048	1103	1184	1265	4
Max. no. of windows in section	2			3			

All prices are net in EUR, the tax needs to be added.

- Net price per set – ex VAT.
- Standard, included in the price: inner bolt from the right side, from the inside.
- Please check width availability before ordering.
- **Surcharge:** – gray RAL 7040, black RAL 9005 – **5%**
 - Golden oak, walnut, mahogany, swamp oak, anthracite sandgrain, anthracite satin, Winchester – **18%**,
 - anthracite – **22%**,
 - black RAL 9005 matt, anthracite micro grove, woodec turner oak – **24%**.

Sectional garage door price list



"STANDARD" tracks

STANDARD doors – standard version with front spring shaft. Min. headroom **300 mm**, min. sideroom width **100 mm**.

Minimum installation dimensions

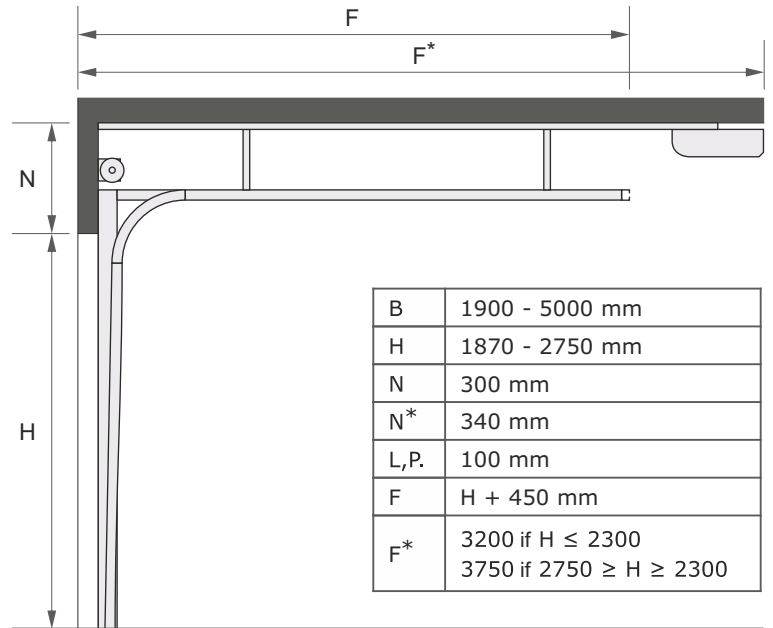
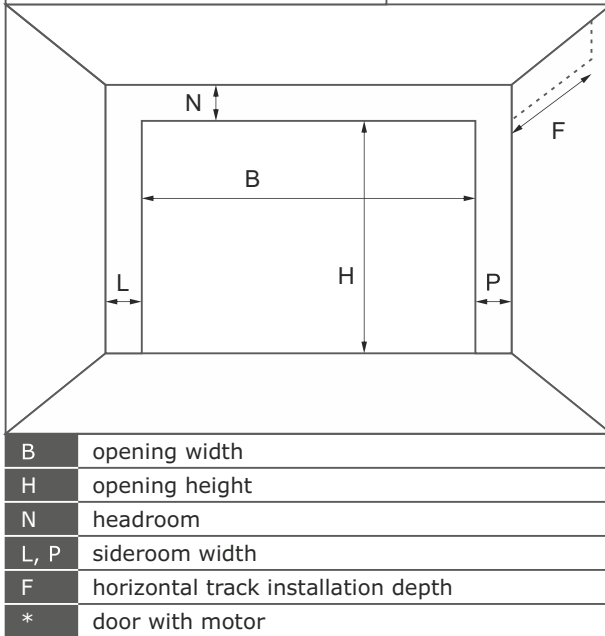

☰ No surcharge – FPGP panel with low ribbing in woodgrain structure, colours: white 9010, brown 8014, anthracite 7016.													
up to	2250	2500	2750	3000	3250	3500	3750	4000	4250	4500	4750	5000	Door sections
1870	606	633	707	761	822	857	953	1015	1081	1138 Ω	1196 Ω	1235 Ω	3
2040	644	660	733	807	888	926	1031	1069	1158	1196 Ω	1273 Ω	1312 Ω	4
2150	664	699	768	838	938	980	1069	1119	1177	1254 Ω	1312 Ω	1351 Ω	4
2260	695	737	811	876	976	1034	1119	1177	1227	1265 Ω	1390 Ω	1428 Ω	4
2370	733	761	849	914	1050	1100	1177	1235	1312	1351 Ω	1505 Ω	1552 Ω	4
2500	811	869	919	1023	1138	1177	1273	1332	1390	1447 Ω	1621 Ω	1660 Ω	5
2750	864	980	1058	1138	1212	1262	1347	1486	1525	1563 Ω	1695 Ω	1737 Ω	5
Max. no. of windows in section	2			3			4			5			

All prices are net in EUR, the tax needs to be added.

☐ ☐ No surcharge – FPGG panel without ribbing in smooth structure – white 9010. No surcharge – FPGS panel with high ribbing in woodgrain structure – white 9010, brown 8014, anthracite 7016.													
up to	2250	2500	2750	3000	3250	3500	3750	4000	4250	4500	4750	5000	Door sections
1870	707	722	799	864	930	946	1031	1116	1175	1235 Ω	1322 Ω	1409 Ω	3
2040	726	745	841	880	916	953	1038	1123	1185	1247 Ω	1332 Ω	1417 Ω	4
2150	745	753	861	957	1034	1111	1149	1185	1233	1282 Ω	1365 Ω	1447 Ω	4
2260	795	807	942	984	1050	1116	1187	1258	1297	1335 Ω	1444 Ω	1552 Ω	4
2370	830	849	957	1042	1114	1185	1254	1324	1387	1451 Ω	1575 Ω	1698 Ω	4
2500	888	907	1042	1100	1166	1231	1311	1390	1451	1513 Ω	1617 Ω	1722 Ω	5
2750	1000	1062	1138	1235	1284	1332	1418	1505	1602	1698 Ω	1756 Ω	1814 Ω	5

All prices are net in EUR, the tax needs to be added.

- Net price per set – ex VAT.
- Standard, included in the price: inner bolt from the right side, from the inside.
- Prices marked with W- Panels reinforced with Omega profile.
- Please check width availability before ordering.

Sectional garage door price list



"STANDARD" tracks

Surcharge. FPGP panel with horizontal low ribbing in woodgrain structure, colours at extra charge – swamp oak, walnut, mahogany, golden oak 18%.													
up to	2250	2500	2750	3000	3250	3500	3750	4000	4250	4500	4750	5000	Door sections
1870	606	633	707	761	822	857	953	1015	1081	1138 Ω	1196 Ω	1235 Ω	3
2040	644	660	733	807	888	926	1031	1069	1158	1196 Ω	1273 Ω	1312 Ω	4
2150	664	699	768	838	938	980	1069	1119	1177	1254 Ω	1312 Ω	1351 Ω	4
2260	695	737	811	876	976	1034	1119	1177	1227	1265 Ω	1390 Ω	1428 Ω	4
2370	733	761	849	914	1050	1100	1177	1235	1312	1351 Ω	1505 Ω	1552 Ω	4
2500	811	869	919	1023	1138	1177	1273	1332	1390	1447 Ω	1621 Ω	1660 Ω	5
2750	864	980	1058	1138	1212	1262	1347	1486	1525	1563 Ω	1695 Ω	1737 Ω	5
Max. no. of windows in section	2			3				4			5		

All prices are net in EUR, the tax needs to be added.

<input type="checkbox"/> Surcharge. FPGG panel without ribbing in smooth structure – anthracite sandgrain, anthracite satin, walnut, winchester, golden oak 18%, colours at extra charge: – anthracite 22%, anthracite micro-groove, woodec turner oak, black RAL 9005 matt 24%.													
<input type="checkbox"/> Surcharge. FPGSG panel with high ribbing in smooth structure, colour at extra charge – swamp oak, walnut, winchester, golden oak – 18%.													
up to	2250	2500	2750	3000	3250	3500	3750	4000	4250	4500	4750	5000	Door sections
1870	707	722	799	864	930	946	1031	1116	1175	1235 Ω	1322 Ω	1409 Ω	3
2040	726	745	841	880	916	953	1038	1123	1185	1247 Ω	1332 Ω	1417 Ω	4
2150	745	753	861	957	1034	1111	1149	1185	1233	1282 Ω	1365 Ω	1447 Ω	4
2260	795	807	942	984	1050	1116	1187	1258	1297	1335 Ω	1444 Ω	1552 Ω	4
2370	830	849	957	1042	1114	1185	1254	1324	1387	1451 Ω	1575 Ω	1698 Ω	4
2500	888	907	1042	1100	1166	1231	1311	1390	1451	1513 Ω	1617 Ω	1722 Ω	5
2750	1000	1062	1138	1235	1284	1332	1418	1505	1602	1698 Ω	1756 Ω	1814 Ω	5

All prices are net in EUR, the tax needs to be added.

<input type="checkbox"/> Surcharge. FPGG panel without ribbing in smooth structure, colours at extra charge – gray RAL 7040, black RAL 9005 5%.													
up to	2250	2500	2750	3000	3250	3500	3750	4000	4250	4500	4750	5000	Door sections
1870	707	722	799	864	930	946	1031	1116	1175	1235 Ω	1322 Ω	1409 Ω	3
2040	726	745	841	880	916	953	1038	1123	1185	1247 Ω	1332 Ω	1417 Ω	4
2150	745	753	861	957	1034	1111	1149	1185	1233	1282 Ω	1365 Ω	1447 Ω	4
2260	795	807	942	984	1050	1116	1187	1258	1297	1335 Ω	1444 Ω	1552 Ω	4
2370	830	849	957	1042	1114	1185	1254	1324	1387	1451 Ω	1575 Ω	1698 Ω	4
2500	888	907	1042	1100	1166	1231	1311	1390	1451	1513 Ω	1617 Ω	1722 Ω	5
2750	1000	1062	1138	1235	1284	1332	1418	1505	1602	1698 Ω	1756 Ω	1814 Ω	5

All prices are net in EUR, the tax needs to be added.

- Net price per set – ex VAT.
- Standard, included in the price: inner bolt from the right side, from the inside.
- Prices marked with W- Panels reinforced with Omega profile.
- Please check width availability before ordering.
- **Surcharge:** – gray RAL 7040, black RAL 9005 – **5%**
 - Golden oak, walnut, mahogany, swamp oak, anthracite sandgrain, anthracite satin, Winchester – **18%**,
 - anthracite – **22%**,
 - black RAL 9005 matt, anthracite micro grove, woodec turner oak – **24%**.

Sectional garage door price list



"LHR+" tracks

LHR+ Garage doors - are a reduced version of garage doors with a front spring shaft. Min.headroom is **200 mm**, min. sideroom width **100 mm**.

Minimum installation dimensions

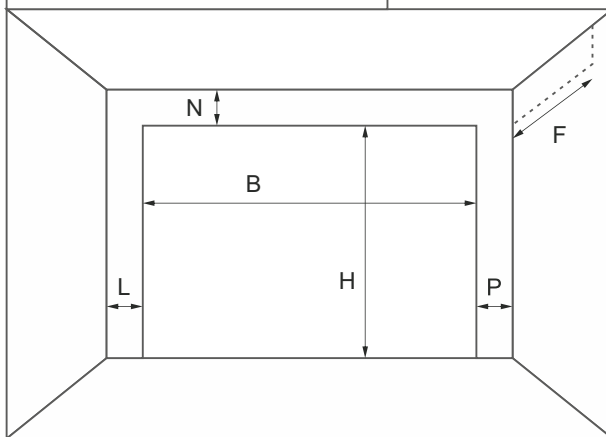

B	opening width
H	opening height
N	headroom
L, P	sideroom width
F	horizontal track installation depth
*	door with motor

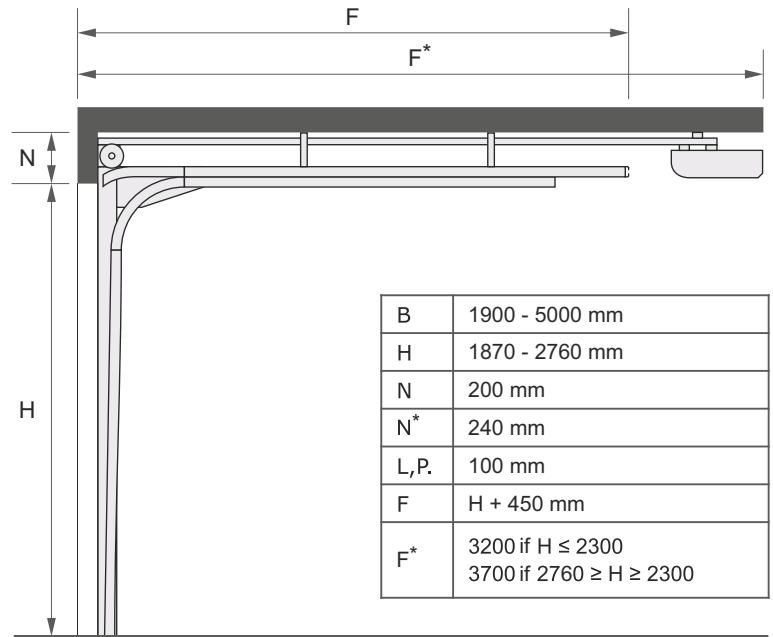

B	1900 - 5000 mm
H	1870 - 2760 mm
N	200 mm
N*	240 mm
L, P.	100 mm
F	H + 450 mm
F*	3200 if H ≤ 2300 3700 if 2760 ≥ H ≥ 2300

No surcharge – FPGP panel with horizontal low robbing in woodgrain structure, colours: white 9010, brown 8014, anthracite 7016.

up to	2250	2500	2750	3000	3250	3500	3750	4000	4250	4500	4750	5000	Door sections
1870	648	652	733	795	846	876	980	1062	1119	1162 Ω	1231 Ω	1270 Ω	3
2040	679	699	776	849	903	930	1042	1138	1181	1235 Ω	1312 Ω	1351 Ω	4
2150	699	710	811	857	957	988	1054	1146	1186	1273 Ω	1351 Ω	1390 Ω	4
2260	741	753	853	907	984	1042	1108	1170	1235	1282 Ω	1385 Ω	1470 Ω	4
2370	764	791	888	946	1116	1185	1258	1332	1390	1436 Ω	1575 Ω	1668 Ω	4
2480	819	870	942	1047	1158	1209	1282	1351	1401	1444 Ω	1631 Ω	1702 Ω	4
2540	826	895	1004	1110	1196	1236	1312	1390	1463	1505 Ω	1702 Ω	1743 Ω	5
2650	951	1031	1100	1158	1243	1297	1444	1544	1582	1621 Ω	—	—	5
2760	980	1065	1119	1196	1285	1337	1459	1567	1610	1629 Ω	—	—	5
Max. no. of windows in section	2			3				4		5			



No surcharge – FPGG panel without ribbing in smooth structure – white 9010.

No surcharge – FPGS panel with high ribbing in woodgrain structure – white 9010, brown 8014, anthracite 7016.

up to	2250	2500	2750	3000	3250	3500	3750	4000	4250	4500	4750	5000	Door sections
1870	741	795	841	873	923	957	1038	1119	1192	1265 Ω	1347 Ω	1428 Ω	3
2040	761	803	849	888	926	965	1046	1127	1200	1273 Ω	1355 Ω	1436 Ω	4
2150	776	807	884	980	1011	1042	1115	1189	1250	1312 Ω	1397 Ω	1482 Ω	4
2260	838	849	973	1019	1073	1127	1191	1254	1322	1390 Ω	1505 Ω	1621 Ω	4
2370	876	896	1027	1081	1162	1243	1302	1362	1418	1475 Ω	1613 Ω	1751 Ω	4
2480	926	938	1052	1102	1183	1273	1339	1405	1463	1521 Ω	1664 Ω	1807 Ω	4
2540	934	942	1102	1113	1202	1277	1345	1412	1470	1528 Ω	1704 Ω	1879 Ω	5
2650	1011	1034	1127	1196	1289	1382	1405	1428	1525	1621 Ω	—	—	5
2760	1062	1089	1159	1305	1347	1390	1451	1513	1639	1764 Ω	—	—	5

All prices are net in EUR, the tax needs to be added.

- Net price per set – ex VAT.
- Standard, included in the price: inner bolt from the right side, from the inside.
- Prices marked with W- Panels reinforced with Omega profile.
- Please check width availability before ordering.

Sectional garage door price list



"LHR+" tracks

Surcharge. FPGP panel with horizontal low ribbing in woodgrain structure, colours at extra charge – swamp oak, walnut, mahogany, golden oak 18%.													
up to	2250	2500	2750	3000	3250	3500	3750	4000	4250	4500	4750	5000	Door sections
1870	648	652	733	795	846	876	980	1062	1119	1162 Ω	1231 Ω	1270 Ω	3
2040	679	699	776	849	903	930	1042	1138	1181	1235 Ω	1312 Ω	1351 Ω	4
2150	699	710	811	857	957	988	1054	1146	1186	1273 Ω	1351 Ω	1390 Ω	4
2260	741	753	853	907	984	1042	1108	1170	1235	1282 Ω	1385 Ω	1470 Ω	4
2370	764	791	888	946	1116	1185	1258	1332	1390	1436 Ω	1575 Ω	1668 Ω	4
2480	819	870	942	1047	1158	1209	1282	1351	1401	1444 Ω	1631 Ω	1702 Ω	4
2540	826	895	1004	1110	1196	1236	1312	1390	1463	1505 Ω	1702 Ω	1743 Ω	5
2650	951	1031	1100	1158	1243	1297	1444	1544	1582	1621 Ω			5
2760	980	1065	1119	1196	1285	1337	1459	1567	1610	1629 Ω			5
Max. no. of windows in section	2			3				4			5		

All prices are net in EUR, the tax needs to be added.

<input type="checkbox"/> Surcharge. FPGG panel without ribbing in smooth structure – anthracite sandgrain, anthracite satin, walnut, winchester, golden oak 18%, colours at extra charge: – anthracite 22%, anthracite micro-groove, woodec turner oak, black RAL 9005 matt 24%.													
<input type="checkbox"/> Surcharge. FPGSG panel with high ribbing in smooth structure, colour at extra charge – swamp oak, walnut, winchester, golden oak – 18%.													
up to	2250	2500	2750	3000	3250	3500	3750	4000	4250	4500	4750	5000	Door sections
1870	741	795	841	873	923	957	1038	1119	1192	1265 Ω	1347 Ω	1428 Ω	3
2040	761	803	849	888	926	965	1046	1127	1200	1273 Ω	1355 Ω	1436 Ω	4
2150	776	807	884	980	1011	1042	1115	1189	1250	1312 Ω	1397 Ω	1482 Ω	4
2260	838	849	973	1019	1073	1127	1191	1254	1322	1390 Ω	1505 Ω	1621 Ω	4
2370	876	896	1027	1081	1162	1243	1302	1362	1418	1475 Ω	1613 Ω	1751 Ω	4
2480	926	938	1052	1102	1183	1273	1339	1405	1463	1521 Ω	1664 Ω	1807 Ω	4
2540	934	942	1102	1113	1202	1277	1345	1412	1470	1528 Ω	1704 Ω	1879 Ω	5
2650	1011	1034	1127	1196	1289	1382	1405	1428	1525	1621 Ω	—	—	5
2760	1062	1089	1159	1305	1347	1390	1451	1513	1639	1764 Ω	—	—	5

All prices are net in EUR, the tax needs to be added.

<input type="checkbox"/> Surcharge. FPGG panel without ribbing in smooth structure, colours at extra charge – gray RAL 7040, black RAL 9005 5%.													
up to	2250	2500	2750	3000	3250	3500	3750	4000	4250	4500	4750	0	Door sections
1870	741	795	841	873	923	957	1038	1119	1192	1265 Ω	1347 Ω	1428 Ω	3
2040	761	803	849	888	926	965	1046	1127	1200	1273 Ω	1355 Ω	1436 Ω	4
2150	776	807	884	980	1011	1042	1115	1189	1250	1312 Ω	1397 Ω	1482 Ω	4
2260	838	849	973	1019	1073	1127	1191	1254	1322	1390 Ω	1505 Ω	1621 Ω	4
2370	876	896	1027	1081	1162	1243	1302	1362	1418	1475 Ω	1613 Ω	1751 Ω	4
2480	926	938	1052	1102	1183	1273	1339	1405	1463	1521 Ω	1664 Ω	1807 Ω	4
2540	934	942	1102	1113	1202	1277	1345	1412	1470	1528 Ω	1704 Ω	1879 Ω	5
2650	1011	1034	1127	1196	1289	1382	1405	1428	1525	1621 Ω	—	—	5
2760	1062	1089	1159	1305	1347	1390	1451	1513	1639	1764 Ω	—	—	5

All prices are net in EUR, the tax needs to be added.

- Net price per set – ex VAT.
- Standard, included in the price: inner bolt from the right side, from the inside.
- Prices marked with W- Panels reinforced with Omega profile.
- Please check width availability before ordering.
- **Surcharge:** – gray RAL 7040, black RAL 9005 – **5%**
 - Golden oak, walnut, mahogany, swamp oak, anthracite sandgrain, anthracite satin, Winchester – **18%**,
 - anthracite – **22%**,
 - black RAL 9005 matt, anthracite micro groove, woodec turner oak – **24%**.

Sectional garage door price list



"RES70" tracks

- RES70 Garage doors - are a specific version of garage doors with a rear spring shaft. Min.headroom is **70 mm**,
- min. sideroom width **100 mm**.

Minimum installation dimensions

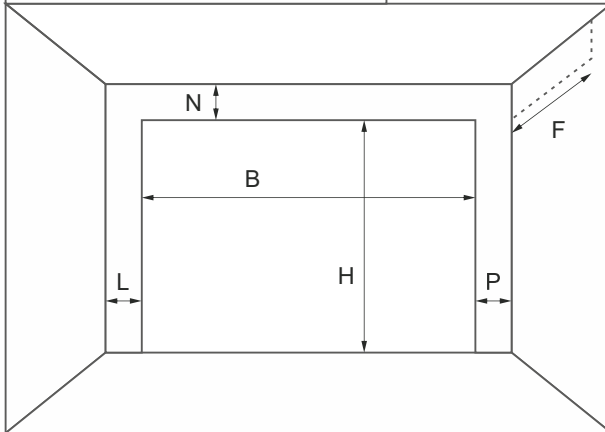

B	opening width
H	opening height
N	headroom
L, P	sideroom width
F	horizontal track installation depth
*	door with motor

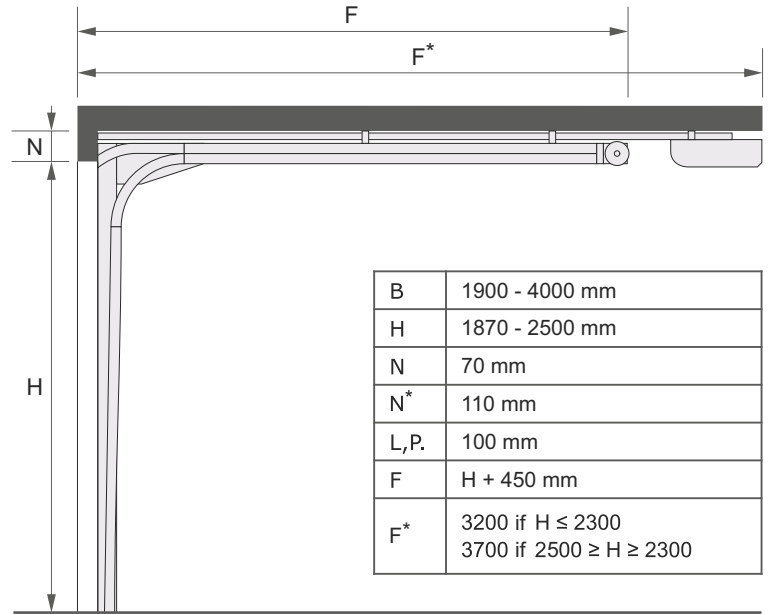

B	1900 - 4000 mm
H	1870 - 2500 mm
N	70 mm
N*	110 mm
L, P.	100 mm
F	H + 450 mm
F*	3200 if H ≤ 2300 3700 if 2500 ≥ H ≥ 2300

No surcharge – FPGP panel with horizontal low ribbing in woodgrain structure, colours: white 9010, brown 8014, anthracite 7016.

up to	2250	2500	2750	3000	3250	3500	3750	4000	Door sections
1870	710	718	795	864	914	946	1050	1138	3
2040	749	753	846	919	973	1011	1104	1216	4
2150	795	814	926	996	1104	1119	1216	1297	4
2260	811	834	934	1003	1181	1250	1332	1405	4
2370	819	841	942	1007	1185	1258	1335	1412	4
2480	888	896	996	1054	1273	1324	1397	1467	4
2500	899	903	1003	1069	1285	1335	1417	1486	5
Max. no. of windows in section	2			3					

All prices are net in EUR, the tax needs to be added.

No surcharge – FPGG panel without ribbing in smooth structure – white 9010.
No surcharge – FPGS panel with high ribbing in woodgrain structure – white 9010, brown 8014, anthracite 7016.

up to	2250	2500	2750	3000	3250	3500	3750	4000	Door sections
1870	772	811	888	896	955	1015	1116	1217	3
2040	776	819	892	899	961	1023	1142	1262	4
2150	819	826	973	1003	1067	1131	1218	1305	4
2260	849	853	984	1034	1148	1262	1287	1313	4
2370	907	914	1042	1096	1198	1298	1364	1430	4
2480	938	946	1081	1131	1237	1344	1413	1482	4
2500	946	949	1084	1135	1253	1372	1435	1499	5

All prices are net in EUR, the tax needs to be added.

- Net price per set – ex VAT.
- Standard, included in the price: inner bolt from the right side, from the inside.
- Prices marked with W- Panels reinforced with Omega profile.
- Please check width availability before ordering.

"RES70" tracks

Surcharge. FPGP panel with horizontal low ribbing in woodgrain structure, colours at extra charge – swamp oak, walnut, mahogany, golden oak 18%.									
up to	2250	2500	2750	3000	3250	3500	3750	4000	Door sections
1870	710	718	795	864	914	946	1050	1138	3
2040	749	753	846	919	973	1011	1104	1216	4
2150	795	814	926	996	1104	1119	1216	1297	4
2260	811	834	934	1003	1181	1250	1332	1405	4
2370	819	841	942	1007	1185	1258	1335	1412	4
2480	888	896	996	1054	1273	1324	1397	1467	4
2500	899	903	1003	1069	1285	1335	1417	1486	5
Max. no. of windows in section	2			3					

All prices are net in EUR, the tax needs to be added.

<input type="checkbox"/> Surcharge. FPGG panel without ribbing in smooth structure – anthracite sandgrain, anthracite satin, walnut, winchester, golden oak 18%, colours at extra charge: – anthracite 22%, anthracite micro-groove, woodec turner oak, black RAL 9005 matt 24%.									
<input type="checkbox"/> Surcharge. FPGSG panel with high ribbing in smooth structure, colour at extra charge – swamp oak, walnut, winchester, golden oak – 18%.									
up to	2250	2500	2750	3000	3250	3500	3750	4000	Door sections
1870	772	811	888	896	955	1015	1116	1217	3
2040	776	819	892	899	961	1023	1142	1262	4
2150	819	826	973	1003	1067	1131	1218	1305	4
2260	849	853	984	1034	1148	1262	1287	1313	4
2370	907	914	1042	1096	1198	1298	1364	1430	4
2480	938	946	1081	1131	1237	1344	1413	1482	4
2500	946	949	1084	1135	1253	1372	1435	1499	5

All prices are net in EUR, the tax needs to be added.

<input type="checkbox"/> Surcharge. FPGG panel without ribbing in smooth structure, colours at extra charge – gray RAL 7040, black RAL 9005 5%.									
up to	2250	2500	2750	3000	3250	3500	3750	4000	Door sections
1870	772	811	888	896	955	1015	1116	1217	3
2040	776	819	892	899	961	1023	1142	1262	4
2150	819	826	973	1003	1067	1131	1218	1305	4
2260	849	853	984	1034	1148	1262	1287	1313	4
2370	907	914	1042	1096	1198	1298	1364	1430	4
2480	938	946	1081	1131	1237	1344	1413	1482	4
2500	946	949	1084	1135	1253	1372	1435	1499	5

All prices are net in EUR, the tax needs to be added.

- Net price per set – ex VAT.
- Standard, included in the price: inner bolt from the right side, from the inside.
- Prices marked with W- Panels reinforced with Omega profile.
- Please check width availability before ordering.
- **Surcharge:** – gray RAL 7040, black RAL 9005 – **5%**
 - Golden oak, walnut, mahogany, swamp oak, anthracite sandgrain, anthracite satin, Winchester – **18%**,
 - anthracite – **22%**,
 - black RAL 9005 matt, anthracite micro groove, woodec turner oak – **24%**.

Windows

There is possibility to use windows mounted in panels (segments). The maximum number of windows depends on the width of the garage doors.

GARAGE DOOR WIDTH	till 2750 mm	2750 - 4000 mm	4000 - 4500 mm	4500 - 5000 mm
MAX. WINDOW QUANTITY IN A PANEL	2	3	4	5

Window nr: **2435R1**

109,50 €



- stainless steel
- double acrylic
- 230x230 mm

Window nr: **2435R2**

138,50 €



- stainless steel
- double acrylic
- 310x310 mm

Window nr: **2435RS1**

308,25 €



- stainless steel
- double glazing
- 230x230 mm

Window nr: **2435RS1-SB**

297,75 €



- stainless steel
- double frosted glazing
- 230x230 mm

Window nr: **2435RS2**

259,25 €



- stainless steel
- double glazing
- 310x310 mm

Window nr: **2435RS2-SB**

346,25 €



- stainless steel
- double frosted glazing
- 310x310 mm

General

Industrial garage doors with front spring shaft are a reinforced version of the standard garage doors. The door curtain is made of hot-dip galvanized, polyester coated 0.5 mm steel sheet. 500 mm or 610 mm high double 40mm panels insulated with CFC-free polyurethane foam and secured with galvanized steel stiles on sides.

The door frame is made of 2 mm hot-dip galvanized steel. The doors feature torsion spring to compensate the door curtain weight and guarantee 25 thousand cycles of operation, i.e. 15 years of failure-free and reliable operation. Optional glazing (rectangular windows) and service access door.

Panels

Industrial doors are available with low horizontal ribbing, in stucco structure.

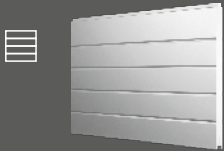
PANEL TYPE	COLOUR	ORANGE PEEL STRUCTURE (stucco)
	white RAL 9002	✓
	brown RAL 8014	✓
	silver RAL 9006	✓
	red RAL 3000	✓
	blue 5010	✓
	anthracite 7016	✓
	green 6005	✓

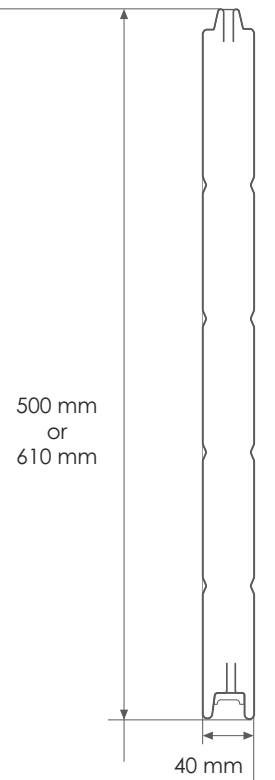

Panel cross-section.

Colours

Door panels are painted on the outside and are always white on the inside.

Standard colours: white (RAL 9002), brown (RAL 8014), silver (RAL 9006), red (RAL 3000), blue (RAL 5010) and anthracite (RAL 7016). Other colours available at additional charge.

COLOUR	SURCHARGE
white RAL 9002, brown RAL 8014	0 %
silver RAL 9006, red RAL 3000	
blue RAL 5010, antracyt RAL 7016	
green RAL 6005	5 %
RAL colour	25,50 €/m ²

All prices are net in EUR, the tax needs to be added.

Minimum installation dimensions

	Manual
B	1800 - 6000 mm
H	1800 - 6000 mm
N	370 mm
L,P	100 mm
F	H + 450 mm

B	opening width
H	opening height
N	headroom
L,P	sideroom width
F	horizontal track installation depth

L,P* min. sideroom width for electric drive - 400 mm

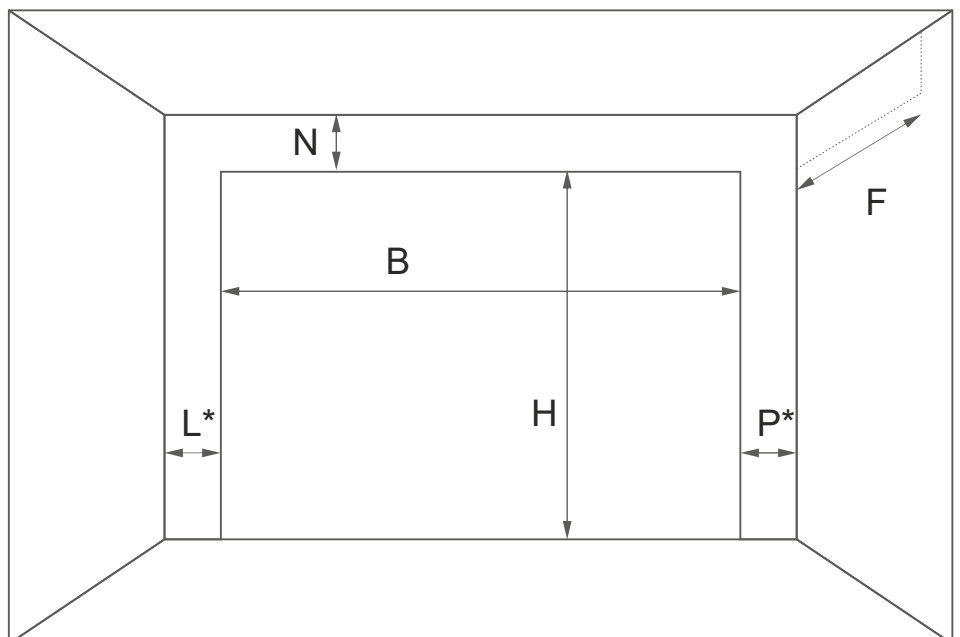

Track types

Five industrial door track versions allows optimal matching of the door type for any installation conditions. We offer standard, high, inclined, high inclined and vertical tracks. Track type details on the next page.

Automatics

We offer special motors for industrial doors adapted to the door size, weight and essentially - to the exploitation intensity.

Min. sideroom width for electric drive - 400 mm.



Set BFT ARGO

BFT ARGO actuator (on shaft mounted) up to 14 m ²	574 €
2-channel remote control	17 €
SPC 3 switch STOP – UP – DOWN	44 €
All prices are net in EUR, the tax needs to be added.	
	635 €

Set SOMMER Totman

Actuator – Sommer (on shaft mounted) up to 30 M. ² 400 VAC (with integrated control in Totman mode).	710 €
Chain for emergency operation 5 m.	
Control console UP/STOP/DOWN.	
Inability to connect the radio receiver	

All prices are net in EUR, the tax needs to be added.

Set SOMMER Automat

SOMMER actuator (on shaft mounted) up to 30 m ² 400 VAC.	900 €
The control system with full automation.	
Control wire from the motor to the control unit, length 5 m.	
Chain for emergency operation 5 m.	
Optical - electrical edge protection OSE	
Control unit doesn't have a radio receiver ! Optional – see page 5.	

All prices are net in EUR, the tax needs to be added.

Optional accessories

Optional accessories available. Additional charges, see table.

Service door with a low threshold and a door closer	727,50 €/pc.
Service door with a standard 15cm threshold and a door closer	628,25 €/pc.
Wired door opening sensor	107,00 €/pc.
Chain gearing 1:4	79,25 €/pc.
Perforated angle iron for suspending L=2000 mm	10,25 €/pc.
Inner bolt	9,75 €/pc.
Lock	56,50 €/pc.
Rectangular window (external frame dimensions 630 x 330)	47,50 €/pc.
Glass-panelled section in aluminium frame (frame - anodized aluminium)	111,25 €/m
Glass-panelled section in aluminium frame (frame in RAL colour)	155,00 €/m
Ventilated panel section in aluminium frame (frame - anodized aluminium)	117,00 €/m
Ventilated panel section in aluminium frame (frame in RAL colour)	156,00 €/m
Plastic gable vent (black / white) 344 mm x 138 mm	27,50 €/pc.
Aluminium gable vent (varnished on RAL colour) 600 mm x 300 mm	93,25 €/pc.

All prices are net in EUR, the tax needs to be added.

Industrial sectional door track types

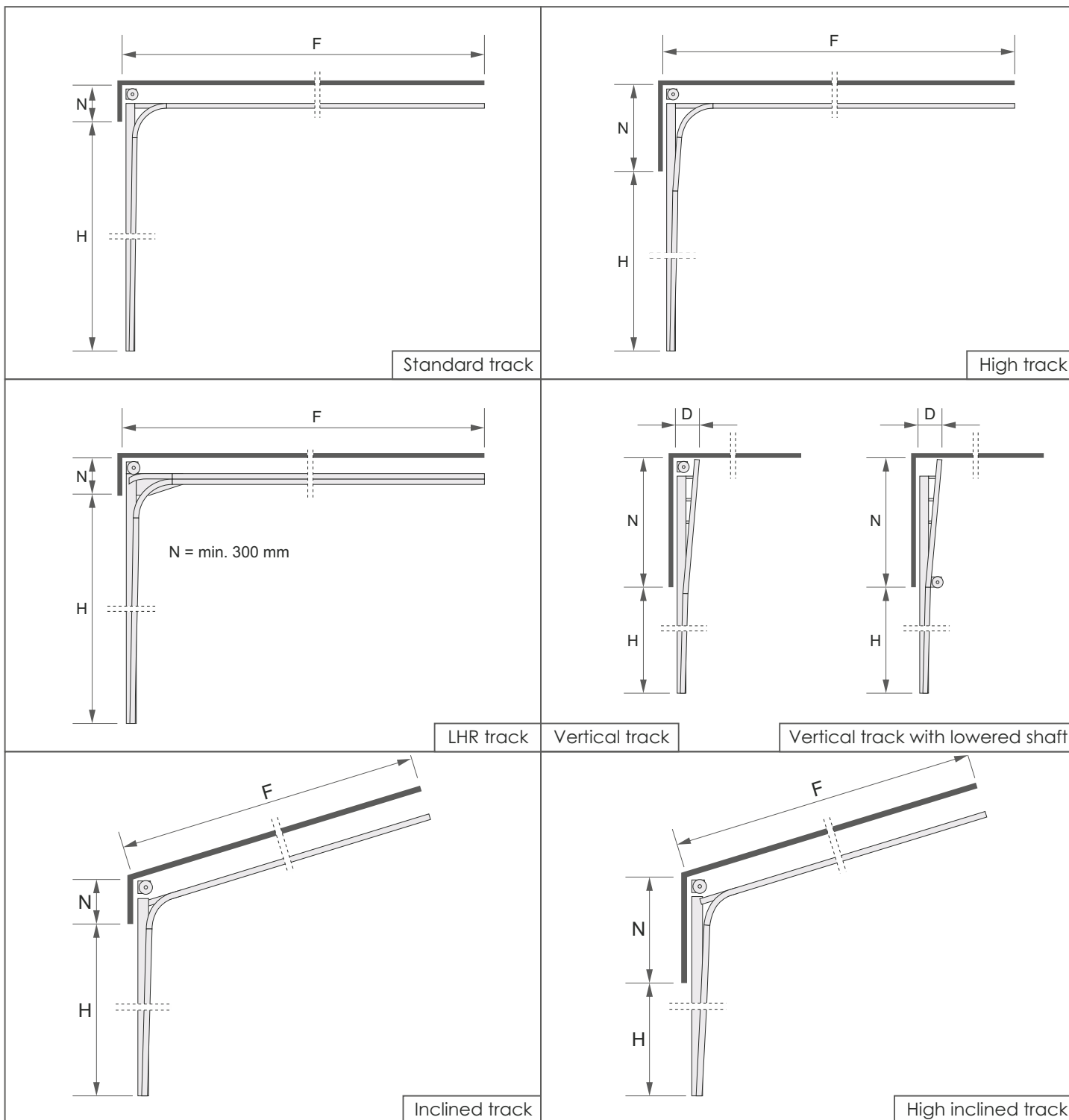

Additional charges for non-standard track:		
High track	750 mm	3%
High track	1370 mm	5%
High track	2000 mm	10%
High track	2500 mm	15%
High track	3050 mm	20%
High track	4115 mm	30%
Vertical track		10%
Vertical track with lowered shaft		25%

Additional charges for non-standard track:		
Inclined track	<8°	2%
Inclined track	<15°	4%
Inclined track	<25°	6%
Inclined track	<30°	12%
Inclined track	<40°	25%
LHR track		10%
Doors for high-moisture environment		100%



up to	2200	2250	2300	2400	2500	2600	2700	2750	2800	2900	3000	3100	Number of segments
2040	926	930	940	956	991	1033	1048	1068	1087	1104	1121	1152	4
2150	930	934	942	957	992	1036	1052	1070	1090	1107	1122	1155	4
2260	934	945	948	963	997	1041	1056	1076	1096	1111	1129	1161	4
2370	953	971	975	991	1027	1073	1090	1099	1110	1127	1144	1186	4
2480	1003	994	997	1015	1052	1096	1113	1124	1135	1152	1169	1223	4
2540	1011	1001	1003	1020	1056	1101	1118	1129	1141	1158	1175	1230	5
2650	1031	1028	1034	1052	1089	1130	1147	1161	1173	1187	1192	1272	5
2760	1081	1087	1090	1110	1149	1193	1212	1222	1232	1238	1243	1298	5
2870	1119	1115	1119	1139	1178	1223	1241	1243	1244	1264	1275	1335	5
2980	1138	1152	1164	1166	1206	1244	1265	1267	1270	1273	1294	1371	5
3090	1158	1158	1169	1172	1212	1252	1272	1271	1275	1282	1301	1378	5
3150	1185	1178	1181	1201	1241	1294	1315	1329	1345	1366	1387	1441	6
3260	1196	1202	1227	1249	1290	1341	1363	1366	1370	1386	1438	1484	6
3370	1282	1278	1282	1289	1333	1382	1405	1420	1434	1457	1482	1532	6
3480	1309	1296	1305	1327	1370	1422	1445	1461	1477	1499	1522	1573	6
3590	1312	1300	1309	1331	1372	1425	1450	1465	1482	1504	1527	1578	6
3700	1390	1399	1424	1450	1402	1547	1573	1588	1604	1630	1657	1725	6
3760	1393	1402	1428	1454	1453	1552	1578	1593	1609	1635	1661	1733	7
3870	1428	1444	1469	1496	1542	1596	1624	1638	1652	1680	1708	1774	7
3980	1467	1487	1514	1542	1588	1633	1661	1687	1711	1741	1756	1797	7
4090	1470	1491	1519	1547	1593	1638	1665	1692	1718	1748	1761	1803	7
4200	1548	1561	1572	1601	1650	1704	1735	1768	1800	1814	1845	1908	7
4310	1621	1615	1625	1655	1708	1780	1812	1817	1822	1831	1862	1930	7
4370	1625	1618	1629	1660	1710	1785	1815	1820	1824	1836	1866	1933	8
4480	1660	1657	1668	1700	1751	1829	1846	1848	1851	1883	1916	1987	8
4590	1679	1673	1686	1711	1771	1848	1865	1868	1871	1903	1936	2007	8
4700	1737	1724	1727	1733	1786	1864	1896	1916	1936	1970	2005	2078	8
4810	1775	1777	1780	1804	1860	1935	1968	1993	2016	2051	2087	2173	8
4920	1787	1780	1783	1815	1868	1940	1976	2000	2027	2061	2095	2182	8
4980	1795	1786	1788	1822	1874	1947	1980	2007	2033	2067	2100	2187	9
5090	1799	1789	1792	1824	1879	1950	1985	2011	2036	2072	2106	2192	9
5200	1922	1930	1944	1979	2037	2107	2145	2175	2206	2245	2282	2363	9
5310	2277	2297	2311	2345	2405	2502	2547	2583	2619	2277	2742	2800	9
5420	2296	2362	2373	2419	2494	2570	2615	2652	2688	2732	2777	2868	9
5530	2354	2369	2380	2427	2501	2578	2622	2660	2696	2742	2787	2877	9
5590	2358	2442	2453	2499	2573	2653	2700	2745	2789	2834	2881	2958	10
5700	2431	2520	2539	2587	2660	2725	2773	2810	2846	2894	2941	3032	10
5810	2509	2609	2643	2692	2768	2838	2888	2924	2959	3008	3057	3149	10
5920	2586	2696	2746	2797	2876	2940	2990	3031	3069	3121	3174	3246	10
6030	2663	2702	2752	2803	2882	2945	2995	3035	3080	3128	3180	3254	10

- Net price per set – ex VAT.
- Standard, included in the price: inner bolt from the right side, from the inside.
- Springs guarantee 25,000 cycles of operation.
- Industrial panel – longitudinal ribbing (no finger protection) White (RAL 9002)/Brown (RAL 8014). Colours visible from the outside.



up to	3200	3250	3300	3400	3500	3600	3700	3750	3800	3900	4000	4250	Number of segments
2040	1169	1181	1193	1210	1227	1323	1340	1345	1348	1356	1378	1417	4
2150	1170	1184	1196	1213	1230	1326	1343	1348	1351	1359	1382	1420	4
2260	1176	1190	1202	1220	1236	1333	1351	1354	1359	1366	1387	1428	4
2370	1202	1209	1215	1224	1263	1361	1380	1384	1387	1396	1419	1461	4
2480	1241	1267	1294	1312	1331	1391	1410	1414	1419	1426	1450	1514	4
2540	1247	1275	1301	1320	1337	1399	1417	1422	1425	1434	1457	1522	5
2650	1292	1321	1351	1359	1371	1428	1448	1462	1477	1507	1532	1596	5
2760	1320	1359	1399	1419	1439	1485	1505	1536	1565	1572	1578	1653	5
2870	1354	1380	1406	1428	1448	1505	1525	1553	1582	1604	1630	1697	5
2980	1392	1414	1451	1459	1479	1541	1562	1579	1598	1620	1646	1740	5
3090	1399	1422	1445	1465	1487	1548	1570	1588	1605	1627	1655	1749	5
3150	1462	1491	1522	1544	1565	1624	1646	1668	1689	1711	1743	1831	6
3260	1505	1528	1549	1562	1605	1671	1694	1710	1729	1751	1781	1883	6
3370	1554	1575	1595	1620	1643	1708	1731	1751	1774	1799	1822	1931	6
3480	1598	1623	1641	1650	1675	1734	1760	1781	1802	1827	1857	1973	6
3590	1602	1624	1646	1655	1680	1740	1764	1786	1808	1832	1864	1979	6
3700	1738	1754	1770	1796	1822	1874	1901	1917	1935	1960	1994	2072	6
3760	1743	1759	1775	1802	1828	1880	1906	1924	1940	1967	2000	2078	7
3870	1786	1802	1818	1846	1874	1925	1952	1967	1980	2008	2042	2124	7
3980	1827	1846	1868	1897	1925	1964	1993	2010	2027	2055	2092	2161	7
4090	1832	1852	1874	1902	1931	1970	1999	2016	2033	2062	2098	2167	7
4200	1939	1962	1985	2016	2039	2104	2135	2149	2164	2195	2234	2266	7
4310	1960	1982	2002	2033	2062	2132	2162	2178	2194	2224	2263	2360	7
4370	1965	1985	2007	2037	2067	2136	2167	2183	2198	2229	2268	2365	8
4480	2018	2040	2062	2093	2125	2195	2227	2246	2263	2294	2336	2435	8
4590	2037	2061	2084	2114	2147	2218	2251	2268	2287	2319	2359	2461	8
4700	2107	2125	2141	2209	2217	2222	2253	2273	2293	2325	2366	2397	8
4810	2209	2212	2217	2229	2262	2350	2383	2456	2530	2565	2611	2877	8
4920	2217	2235	2255	2289	2323	2413	2447	2522	2599	2635	2682	2951	8
4980	2223	2243	2262	2297	2331	2419	2455	2530	2608	2643	2689	2959	9
5090	2227	2248	2266	2302	2336	2425	2459	2536	2612	2648	2696	2966	9
5200	2402	2427	2453	2490	2527	2611	2648	2703	2757	2796	2845	3061	9
5310	2846	2882	2919	2964	3008	3083	3129	3152	3174	3218	3276	3407	9
5420	2914	2943	2971	3016	3063	3140	3185	3215	3246	3293	3349	3489	9
5530	2924	2951	2980	3025	3072	3149	3195	3226	3256	3302	3361	3499	9
5590	3006	3032	3060	3106	3152	3249	3296	3316	3336	3382	3443	3581	10
5700	3078	3090	3102	3151	3197	3332	3378	3398	3419	3465	3527	3667	10
5810	3199	3199	3200	3248	3297	3412	3460	3481	3499	3549	3611	3760	10
5920	3298	3330	3362	3379	3398	3465	3523	3574	3625	3660	3695	3844	10
6030	3305	3337	3369	3386	3404	3481	3530	3581	3632	3667	3701	3852	10

- Net price per set – ex VAT.
- Standard, included in the price: inner bolt from the right side, from the inside.
- Springs guarantee 25,000 cycles of operation.
- Industrial panel – longitudinal ribbing (no finger protection) White (RAL 9002)/Brown (RAL 8014). Colours visible from the outside.

up to	4500	4750	5000	5250	5500	5750	6000	6250	6500	6750	7000	Number of segments
2040	1521	1653	1701	2065	2114	2132	2249	2388	2501	2629	2743	4
2150	1524	1657	1707	2069	2120	2136	2254	2393	2506	2635	2749	4
2260	1532	1665	1715	2080	2131	2147	2266	2405	2520	2648	2763	4
2370	1565	1704	1719	2107	2176	2195	2313	2456	2572	2705	2820	4
2480	1625	1741	1858	2139	2214	2287	2362	2494	2620	2748	2868	4
2540	1633	1750	1868	2150	2226	2299	2374	2506	2634	2762	2884	5
2650	1676	1794	1917	2203	2275	2413	2547	2614	2748	2813	2931	5
2760	1740	1865	1990	2282	2419	2558	2626	2762	2899	2950	3061	5
2870	1786	1914	2042	2340	2482	2624	2696	2833	2974	3027	3140	5
2980	1832	1964	2095	2402	2620	2688	2757	2899	3041	3176	3288	5
3090	1842	1975	2106	2414	2632	2702	2771	2912	3057	3191	3304	5
3150	1880	2013	2180	2467	2691	2754	2828	2968	3112	3248	3356	6
3260	1979	2076	2263	2530	2757	2905	2971	3116	3264	3404	3512	6
3370	2033	2128	2319	2595	2825	2974	3038	3183	3336	3475	3579	6
3480	2076	2176	2373	2649	2882	3035	3188	3340	3396	3535	3744	6
3590	2083	2184	2379	2658	2891	3044	3199	3351	3407	3546	3755	6
3700	2183	2289	2561	2782	3025	3363	3530	3693	3862	4012	4114	6
3760	2189	2295	2569	2789	3035	3374	3541	3703	3875	4024	4126	7
3870	2243	2351	2627	2858	3100	3447	3614	3781	3951	4101	4200	7
3980	2280	2391	2675	2907	3154	3503	3740	3910	4088	4241	4335	7
4090	2288	2399	2685	2914	3163	3513	3751	3921	4100	4253	4348	7
4200	2394	2510	2879	3047	3305	3667	3913	4083	4265	4418	4506	7
4310	2444	2561	2937	3105	3363	3732	3979	4154	4336	4489	4570	7
4370	2448	2565	2944	3111	3370	3740	3987	4162	4344	4497	4580	8
4480	2476	2595	2973	3143	3404	3774	4026	4194	4378	4531	4608	8
4590	2501	2621	3002	3176	3439	3813	4066	4236	4422	4576	4656	8
4700	2624	2641	3084	3226	3459	3470	4270	4552	4598	4768	5023	8
4810	3001	3123	3189	3365	3643	4034	4290	4643	4659	4813	5739	8
4920	3076	3203	3234	3513	3904	4086	4347	4679	4714	5691	6051	8
4980	3086	3214	3243	3524	3914	4098	4361	4693	4728	5709	6070	9
5090	3094	3220	3249	3532	3922	4106	4369	4857	4737	5720	6082	9
5200	3188	3319	3446	3813	4083	4270	4453	4939	5670	5749	6112	9
5310	3549	3691	3830	4049	4220	4410	5344	5645	5728	5992	6377	9
5420	3631	3772	3914	4137	4285	5139	5441	5745	6005	6086	6485	9
5530	3641	3785	3927	4149	4299	5156	5458	5763	6023	6105	6504	9
5590	3728	3870	4017	4241	5178	5323	5643	5951	6218	6303	6736	10
5700	3798	3956	4114	5056	5339	5540	5784	6009	6278	6363	6800	10
5810	3901	4054	4208	5219	5403	5605	5850	6075	6345	6434	6871	10
5920	3995	4142	4292	5985	6073	6326	6766	7033	7203	7256	7877	10
6030	4002	4149	4301	5997	6085	6338	6778	7048	7216	7272	7893	10

Panels reinforced with Ω profile

- Net price per set – ex VAT.
- Standard, included in the price: inner bolt from the right side, from the inside.
- Over 4500 mm – panels reinforced with Ω profile
- Springs guarantee 25,000 cycles of operation.
- Industrial panel – longitudinal ribbing (no finger protection) White (RAL 9002)/Brown (RAL 8014). Colours visible from the outside.

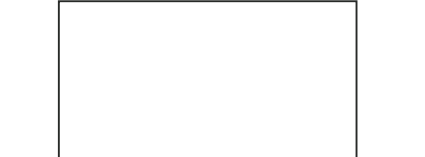
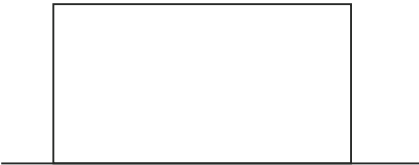

ORDER FOR PRODUCING A GARAGE DOOR

GARAGE DOOR TYPE:	HOME-X	RSC	STANDARD	LHR+	RES70
Client:	Order no.:				
Quantity:	Delivery date:				
Panel type:	Panel colour:				
Opening dimensions:	Height.....mm		Width.....mm		
Headroom:	Sideroom width:				
Garage length:	Manual drive		Electric drive		
Rectangular windows:	Quantity of windows: (please include a reference drawing)				
Glass-panelled section:	Quantity of glass-panelled sections: (please include a reference drawing)				
Burglar-proofing:	Inner bolt		Lock		
<input type="checkbox"/> rear crossbar <input type="checkbox"/> headroom profile with a seal	Wicket in garage door..... (opening outwards)				
Optional accessories: <input type="checkbox"/> <input type="checkbox"/> <input type="checkbox"/> <input type="checkbox"/>	Opening (view from the outside, from the hinge) <div style="display: flex; justify-content: space-around; margin-top: 10px;"> left right </div> Wicket location: <div style="text-align: center; margin-top: 10px;">  </div> Reference drawing from the outside.				
Reference drawing from the outside. <div style="text-align: center; margin-top: 20px;">  </div>	date, stamp and authorized signature				

Note: By garage doors without motor please specify, if you plan to install it in the future.

Note: (garage doors with motor) – emergency release from the outside must be installed if there is no other access to the garage available.

– mark selected items X

ORDER FOR PRODUCING AN INDUSTRIAL SECTIONAL DOOR. 1.

Client:		Order no.:	
Track type: <input type="checkbox"/> Standard <input type="checkbox"/> Vertical <input type="checkbox"/> LHR+ <input type="checkbox"/> Vertical with lowered shaft. <input type="checkbox"/> High (.....) <input type="checkbox"/> High inclined (.....) <input type="checkbox"/> Inclined			
Quantity:		Delivery date:	
Panel colour: <input type="checkbox"/> white RAL 9010 <input type="checkbox"/> blue RAL 5010 <input type="checkbox"/> brown RAL 8014 <input type="checkbox"/> anthracite RAL 7016 <input type="checkbox"/> silver RAL 9006 <input type="checkbox"/> green RAL 6005 <input type="checkbox"/> red RAL 3000 <input type="checkbox"/> RAL colour:			
Headroom height:		Sideroom width:	
Opening dimensions: Height mm Width mm			
Manual drive <input type="checkbox"/> chain gearing <input type="checkbox"/> cable for lower down			
Electric drive <input type="checkbox"/> BFT ARGO (<input type="checkbox"/> remote control – pcs: or <input type="checkbox"/> SPC3 switcher - pcs:) <input type="checkbox"/> SOMMER Totman <input type="checkbox"/> SOMMER Automat			

Note: By garage doors without motor please specify, if you plan to install it in the future.

Note: (doors with motor) – emergency release from the outside must be installed if no other access to the garage is available.

– mark selected items X



ORDER FOR PRODUCING AN INDUSTRIAL SECTIONAL DOOR. 2.

Glazing: rectangular windows Quantity of windows:
(please include a reference drawing)

glass-panelled sections Quantity of windows:
(please include a reference drawing)

↓

frame raw aluminum

frame RAL colour.....

Reference drawing from the outside:

Burglar-proofing: Inner bolt Lock

Wicket **Wicket location:**
(opening outwards) (Reference drawing from the outside.)

Opening
(view from the outside, from the hinge)

left right

Options:

standard 15 cm threshold

low threshold

wicket opening sensor

Optional accessories:

<input type="checkbox"/>	<input type="checkbox"/>
<input type="checkbox"/>	<input type="checkbox"/>
<input type="checkbox"/>	<input type="checkbox"/>

General Provisions

1. General Terms and Conditions of Sale shall apply to the sale of products of the Fart Produkt sp. z o.o. sp.k. company having its registered office in Toruń at ul. Towarowa 3, entered into the National Court Register under the number 0000615850.
2. The sale shall be made to the economic operators cooperating with Fart-Produkt, hereinafter referred to as Trading Partners.
3. Price list does not constitute an offer within the meaning of the Civil Code.
4. Trading Partner is a separate, economic operator independent of the Fart-Produkt.
5. Trading Partners operate in their own name and on their own account.
6. Trading Partner may use trademarks of Fart-Produkt only with the consent of Fart-Produkt or only for the purpose of identifying Fart-Produkt as the manufacturer of a product.
7. All trade information obtained from Fart-Produkt shall be confidential and should not be disclosed by Trading Partner to any third parties.
8. Business Days within the meaning of this Terms and Conditions of Sale shall mean days from Monday to Friday excluding public holidays.

Obligations and Liabilities of Trading Partner

1. Having relevant expertise for the purpose of optimal selection of products from the wide range of products offered by Fart-Produkt.
2. Having relevant expertise for the purpose of proper assembly of products from the wide range of products offered by Fart-Produkt.
3. Providing customers with true information about products from the wide range of products offered by Fart-Produkt.
4. Displaying advertising materials and relevant information about Fart-Produkt as the manufacturer of the products.
5. Providing services during the period.
6. Providing post- services according to individual agreements with customers.
7. Handling of customer complaints pertaining to the products offered by Fart-Produkt, in accordance with the complaints procedure.
8. Protecting good reputation and corporate image of Fart-Produkt by providing reliable service, proper assembly as well as providing maintenance services on products from the wide range of products offered by Fart-Produkt.
9. Ensuring that proper storage conditions will be maintained for products delivered by Fart-Produkt, including proper display of products offered by Fart-Produkt.

Prices

1. Prices of products offered by Fart-Produkt are indicated in price list valid on a given date. Prices quoted are net prices. VAT should be added to the given prices at the rate applying on the date when the tax obligation arises.
2. Prices indicated in price lists of Fart-Produkt are expressed in Euro.
3. Prices indicated in price lists of Fart-Produkt are recommended retail prices, on which discount will apply for Trading Partner. Discounts shall be settled individually.
4. Prices indicated in price lists do not include assembly.
5. Fart-Produkt reserves the right to modify the price list. Any modification to the price list will be communicated to Trading Partners when published on the site www.fartprodukt.pl, via e-mail and by sales representatives of Fart-Produkt.

Orders

1. Trading Partner shall place Orders in writing using order forms prepared by Fart-Produkt.
2. Order forms shall be delivered together with price lists and are available on the site www.fartprodukt.pl.
3. Orders can be placed via fax or internet. By placing an order Trading Partner accepts the General Terms and Conditions of Sale and Trading Partner shall bear full responsibility for the content of order, which he has placed.
4. Orders placed in other form than by order forms will extend the order completion period and Fart-Produkt shall not be responsible for interpretation of data included in such orders.
5. Any modifications of orders require written form and they will extend the order completion period.
6. If an order is in progress the costs related to any modification of such order will be borne by Trading Partner.
7. Non-standard orders as well as orders under which lacquering of elements of finished product is required will extend the order completion period to 3 weeks.
8. Placing an order is considered as acceptance of the General Terms and Conditions of Sale.

Terms of payment

1. Trading Partner is obliged to pay for ordered and purchased products on the date indicated in the invoice. The payment deadline shall be the date on which bank account of Fart-Produkt has been credited.
2. The terms, like: advance payments, form and the payment deadline will be determined individually for every Trading Partner.
3. If Trading Partner exceeds the payment deadline it may result in charging statutory interest for late payment by Fart-Produkt, suspension of execution of successive orders, refusal to deliver ordered products, modifying the terms of payment.
4. In case the payment deadline has been exceeded and compulsory enforcement of payment due to Fart-Produkt by debt collection agency is necessary, then Trading Partner authorises Fart-Produkt to charge Trading Partner with costs related to recovery of due amount.

Warranty

1. Fart-Produkt shall provide a 24-month warranty for delivered products to Trading Partner.
2. The warranty period shall commence on the date of issuing an invoice to Trading Partner.
3. Warranty provided by Fart-Produkt shall be valid only with a relevant document confirming the purchase of the product i.e. VAT invoice or receipt.
4. If damage is discovered which could not be objectively noticed externally over delivery, the Trade Partner should report the disclosed damage immediately, but no later than within 7 days from the date of delivery.
5. Upon delivery, the Trade Partner is obliged to check the consistency of the delivery with the invoice or WZ document. Any contradictions and failings should be reported by the Trade Partner immediately, but not later than within 7 days from the date of delivery.
6. Trading Partner shall act as the Guarantor unto customer.
7. The Guarantor performs his duties at his headquarters, in the place of business. The customer is obliged to transport the goods subject by the warranty notification to the place specified in point 1 of the General Provisions of these General Sales Conditions. If the Guarantor makes regular deliveries to the customer, the goods subjected by the complaint may be picked up from the customer's point, after prior arrangement of such a possibility.

8. When delivering the goods subjected by the complaint, the customer is obliged to properly secure and pack it. The customer bears the costs for any damage resulting on the score of unsecured goods.
9. The Guarantor does not bear the costs of assembly, disassembly, commuting, or any other costs directly or indirectly related to the assembly or disassembly of the goods subjected by the warranty.
10. The Customer's rights under the Warranty are limited only to the defective part of the goods, unless it cannot be separated from the rest of the goods.
11. Assembly of products of Fart-Produkt shall be performed by dedicated and trained assembly teams, otherwise the warranty rights shall be deemed null and void.
12. The warranty does not cover:
 - damage caused by Trading Partner or persons for whom Trading Partner shall be responsible as well as damage caused by third parties.
 - natural wear and tear of the products, incorrect assembly, incorrect start-up, inappropriate use of the product, impact of external factors.
 - discoloration and other changes in the surface properties of elements caused by the influence of atmospheric factors as well as differences in the shades of colours between template and a real finished product.
 - defects of indentations, scratches, damages, if they resulted from inappropriate transport of products by Trading Partner.
 - damages resulting from random events (fire, flood, etc.)
 - damages resulting from improper storage of products by Trading Partner.
 - oversized products ordered on special request of Trading Partner.
13. Trading Partner shall bear the costs of transport to the place of complaint.
14. In case of unjustified call for expert of Fart-Produkt to the place of complaint, Fart-Produkt shall charge Trading Partner with the costs incurred.
15. Interference in visual elements of products, i.e. removing stickers, logo, rating plates shall result in the loss of warranty rights.
16. Trading Partner shall lose the warranty rights in case Trading Partner or any third parties will make any modifications or unauthorised repairs of the products.
17. Guarantee will cover damages caused by courier company only in case of writing a proper damage protocol in the presence of the courier by Trading Partner.

Final Provisions

1. Any disputes which may arise between Fart-Produkt and Trading Partner, if they cannot be settled amicably, will be dealt with by common courts, with jurisdiction over the registered office of Fart-Produkt.
2. Any matters not provided for in the provisions of Cooperation Agreement or the General Terms and Conditions of Sale shall be governed by the Civil Code.

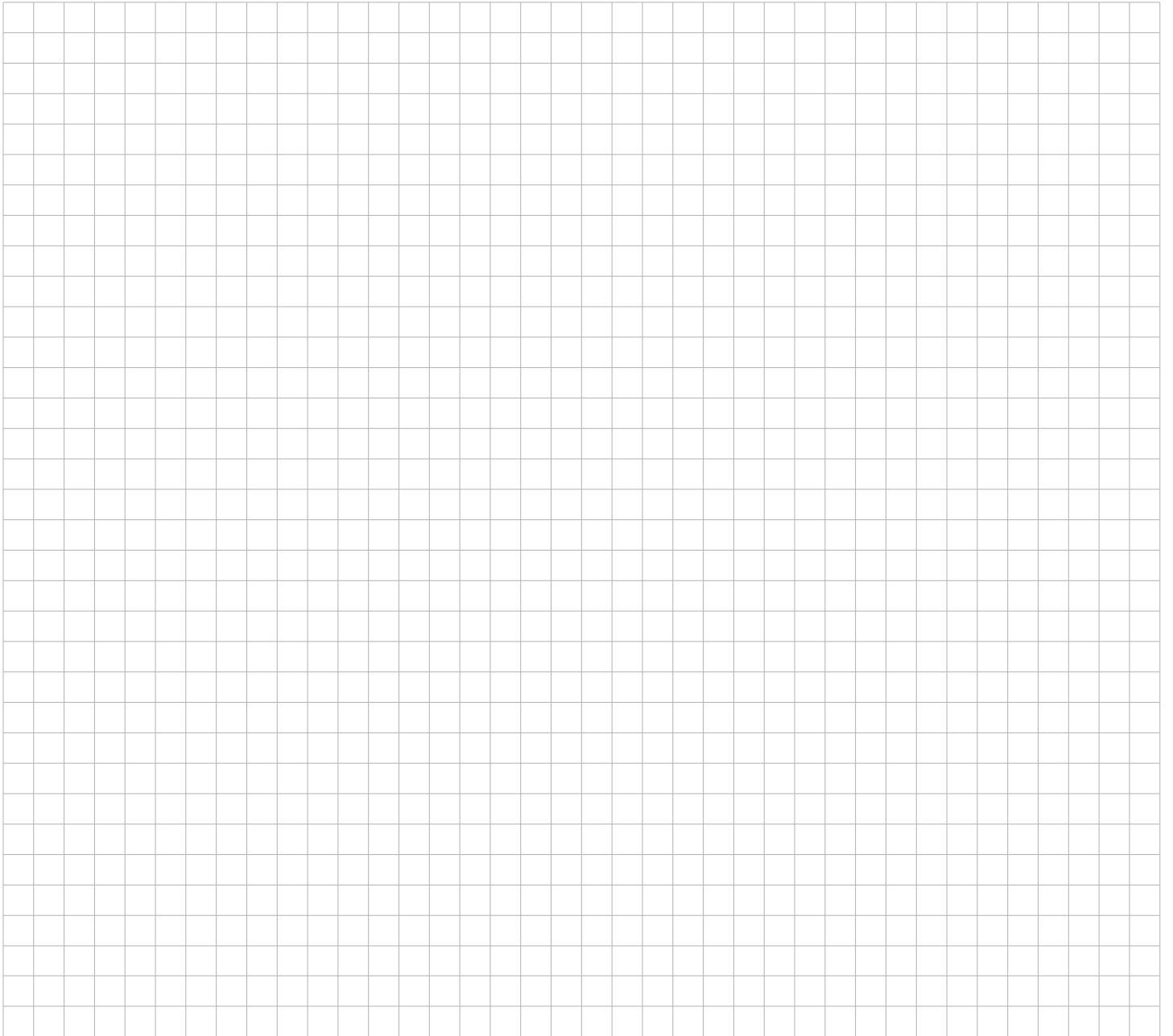

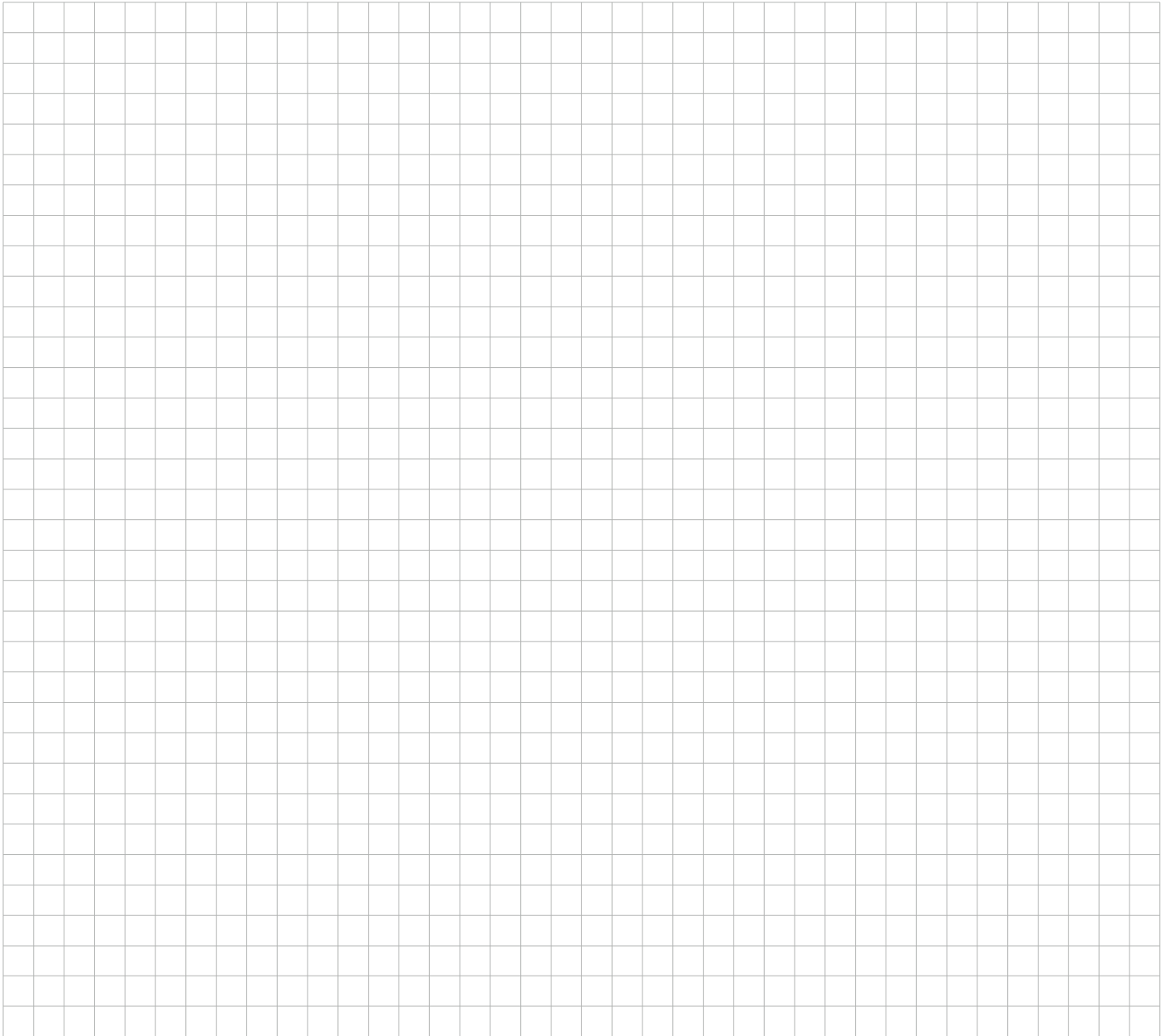

All rights reserved.

The property rights to texts, drawings, photos and all other information published in this price list belong to Fart Produkt Ltd. limited partnership, Towarowa street 3, 87-100 Toruń. It is forbidden to use, duplicate, distribute or modify the submitted graphic materials in a manner other than specified in the contract with Fart Produkt Ltd. limited partnership, Towarowa street 3, 87-100 Toruń. Fart Produkt Ltd. limited partnership, Towarowa street 3, 87-100 Toruń reserves the right to withdraw consent to the use, reproduction, distribution or modification of received graphic materials.

Fart Produkt Ltd. Limited partnership,
Towarowa street 3, 87-100 Toruń



Sp. z o.o. sp. k. Fart Produkt
ul. Towarowa 3
87-100 Toruń
tel. +48 56 623 55 77
www.fartprodukt.pl
export@fartprodukt.pl

our partner