



Roller shutter Price List



edition 15.03.2023

\ 1 General terms of sale

\ 2 - 13 System SK45⁰ / Owal / SKP

- 2 - 5 SK45⁰ / Owal / SKP on an aluminum profile 39 mm
- 6 - 9 SK45⁰ / Owal / SKP on an aluminum profile 43 mm
- 10 - 13 SK45⁰ / Owal / SKP on an aluminum profile 52 mm

\ 14 - 25 System SP-E

- 14 - 17 SP-E on an aluminum profile 39 mm
- 18 - 21 SP-E on an aluminum profile 43 mm
- 22 - 25 SP-E on an aluminum profile 52 mm

\ 26 - 33 System BECLEVER

- 26 - 29 BECLEVER on an aluminum profile 39 mm
- 30 - 33 BECLEVER on an aluminum profile 43 mm

\ 34 - 41 System OPOTERM

- 34 - 37 OPOTERM on an aluminum profile 39 mm
- 38 - 41 OPOTERM on an aluminum profile 43 mm

\ 42 - 49 System REVO

- 42 - 45 REVO on an aluminum profile 39 mm
- 46 - 49 REVO on an aluminum profile 43 mm

\ 50 - 60 Drives and accessories

- 50 - 57 Drives and accessories
- 58 Services
- 59 - 60 Selection of roller shutter drives

\ 61 - 70 Order forms

- 61 - 65 Order forms SK45⁰ / Owal / SKP / SP-E
- 66 - 70 Order forms REVO / BECLEVER / OPOTERM



General Provisions

1. General Terms and Conditions of Sale shall apply to the sale of products of the Fart Produkt sp. z o.o. sp.k. company having its registered office in Toruń at ul. Towarowa 3, entered into the National Court Register under the number 0000615850.
2. The sale shall be made to the economic operators cooperating with Fart-Produkt, hereinafter referred to as Trading Partners.
3. Price list does not constitute an offer within the meaning of the Civil Code.
4. Trading Partner is a separate, economic operator independent of the Fart-Produkt.
5. Trading Partners operate in their own name and on their own account.
6. Trading Partner may use trademarks of Fart-Produkt only with the consent of Fart-Produkt or only for the purpose of identifying Fart-Produkt as the manufacturer of a product.
7. All trade information obtained from Fart-Produkt shall be confidential and should not be disclosed by Trading Partner to any third parties.
8. Business Days within the meaning of this Terms and Conditions of Sale shall mean days from Monday to Friday excluding public holidays.

Obligations and Liabilities of Trading Partner

1. Having relevant expertise for the purpose of optimal selection of products from the wide range of products offered by Fart-Produkt.
2. Having relevant expertise for the purpose of proper assembly of products from the wide range of products offered by Fart-Produkt.
3. Providing customers with true information about products from the wide range of products offered by Fart-Produkt.
4. Displaying advertising materials and relevant information about Fart-Produkt as the manufacturer of the products.
5. Providing services during the period.
6. Providing post- services according to individual agreements with customers.
7. Handling of customer complaints pertaining to the products offered by Fart-Produkt, in accordance with the complaints procedure.
8. Protecting good reputation and corporate image of Fart-Produkt by providing reliable service, proper assembly as well as providing maintenance services on products from the wide range of products offered by Fart-Produkt.
9. Ensuring that proper storage conditions will be maintained for products delivered by Fart-Produkt,

including proper display of products offered by Fart-Produkt.

Prices

1. Prices of products offered by Fart-Produkt are indicated in price list valid on a given date. Prices quoted are net prices. VAT should be added to the given prices at the rate applying on the date when the tax obligation arises.
2. Prices indicated in price lists of Fart-Produkt are expressed in Euro.
3. Prices indicated in price lists of Fart-Produkt are recommended retail prices, on which discount will apply for Trading Partner. Discounts shall be settled individually.
4. Prices indicated in price lists do not include assembly.
5. Fart-Produkt reserves the right to modify the price list. Any modification to the price list will be communicated to Trading Partners when published on the site www.fartprodukt.pl, via e-mail and by sales representatives of Fart-Produkt.

Orders

1. Trading Partner shall place Orders in writing using order forms prepared by Fart-Produkt.
2. Order forms shall be delivered together with price lists and are available on the site www.fartprodukt.pl.
3. Orders can be placed via fax or internet. By placing an order Trading Partner accepts the General Terms and Conditions of Sale and Trading Partner shall bear full responsibility for the content of order, which he has placed.
4. Orders placed in other form than by order forms will extend the order completion period and Fart-Produkt shall not be responsible for interpretation of data included in such orders.
5. Any modifications of orders require written form and they will extend the order completion period.
6. If an order is in progress the costs related to any modification of such order will be borne by Trading Partner.
7. Non-standard orders as well as orders under which lacquering of elements of finished product is required will extend the order completion period to 3 weeks.
8. Placing an order is considered as acceptance of the General Terms and Conditions of Sale.

Terms of payment

1. Trading Partner is obliged to pay for ordered and purchased products on the date indicated in the invoice. The payment deadline shall be the date on which bank account of Fart-Produkt has been credited.
2. The terms, like: advance payments, form and the

payment deadline will be determined individually for every Trading Partner.

3. If Trading Partner exceeds the payment deadline it may result in charging statutory interest for late payment by Fart-Produkt, suspension of execution of successive orders, refusal to deliver ordered products, modifying the terms of payment.
4. In case the payment deadline has been exceeded and compulsory enforcement of payment due to Fart-Produkt by debt collection agency is necessary, then Trading Partner authorises Fart-Produkt to charge Trading Partner with costs related to recovery of due amount.

Warranty

1. Fart-Produkt shall provide a 24-month warranty for delivered products to Trading Partner.
2. The warranty period shall commence on the date of issuing an invoice to Trading Partner.
3. Warranty provided by Fart-Produkt shall be valid only with a relevant document confirming the purchase of the product i.e. VAT invoice or receipt.
4. If damage is discovered which could not be objectively noticed externally over delivery, the Trade Partner should report the disclosed damage immediately, but no later than within 7 days from the date of delivery.
5. Upon delivery, the Trade Partner is obliged to check the consistency of the delivery with the invoice or WZ document. Any contradictions and failings should be reported by the Trade Partner immediately, but not later than within 7 days from the date of delivery.
6. Trading Partner shall act as the Guarantor unto customer.
7. The Guarantor performs his duties at his headquarters, in the place of business. The customer is obliged to transport the goods subject by the warranty notification to the place specified in point 1 of the General Provisions of these General Sales Conditions. If the Guarantor makes regular deliveries to the customer, the goods subjected by the complaint may be picked up from the customer's point, after prior arrangement of such a possibility.
8. When delivering the goods subjected by the complaint, the customer is obliged to properly secure and pack it. The customer bears the costs for any damage resulting on the score of unsecured goods.
9. The Guarantor does not bear the costs of assembly, disassembly, commuting, or any other costs directly or indirectly related to the assembly or disassembly of the goods subjected by the warranty.
10. The Customer's rights under the Warranty are limited only to the defective part of the goods, unless it cannot be separated from the rest of the goods.
11. Assembly of products of Fart-Produkt shall be

performed by dedicated and trained assembly teams, otherwise the warranty rights shall be deemed null and void.

12. The warranty does not cover:

- damage caused by Trading Partner or persons for whom Trading Partner shall be responsible as well as damage caused by third parties.
 - natural wear and tear of the products, incorrect assembly, incorrect start-up, inappropriate use of the product, impact of external factors.
 - discoloration and other changes in the surface properties of elements caused by the influence of atmospheric factors as well as differences in the shades of colours between template and a real finished product.
 - defects of indentations, scratches, damages, if they resulted from inappropriate transport of products by Trading Partner.
 - damages resulting from random events (fire, flood, etc.)
 - damages resulting from improper storage of products by Trading Partner.
 - oversized products ordered on special request of Trading Partner.
13. Trading Partner shall bear the costs of transport to the place of complaint.
 14. In case of unjustified call for expert of Fart-Produkt to the place of complaint, Fart-Produkt shall charge Trading Partner with the costs incurred.
 15. Interference in visual elements of products, i.e. removing stickers, logo, rating plates shall result in the loss of warranty rights.
 16. Trading Partner shall lose the warranty rights in case Trading Partner or any third parties will make any modifications or unauthorised repairs of the products.
 17. Guarantee will cover damages caused by courier company only in case of writing a proper damage protocol in the presence of the courier by Trading Partner.

Final Provisions

1. Any disputes which may arise between Fart-Produkt and Trading Partner, if they cannot be settled amicably, will be dealt with by common courts, with jurisdiction over the registered office of Fart-Produkt.
2. Any matters not provided for in the provisions of Cooperation Agreement or the General Terms and Conditions of Sale shall be governed by the Civil Code.

Price list for external roller shutters - SK45⁰ / Oval / SKP system on a 39 mm aluminum profile

- aluminum box cut at an angle of 45 degrees "SK 45" or - with extra charge - rounded "Oval" or semi-circular "SKP".
- 53 mm wide aluminum guides straight or - with extra charge - PK53, PPMO.
- 39 mm aluminum profile filled with polyurethane foam (weight 2.8 kg / m²).
- maximum dimensions: width 3200 mm, height 3500 mm (for 1 class wind resistance according to EN13659).
- manual drive in the form of a box coiler for cord or tape (maximum weight for curtain: up to 12 kg).
- maximum roller shutter surface 6 m².



39 mm „PA-39“ aluminum profile.

"PP-53" guide.

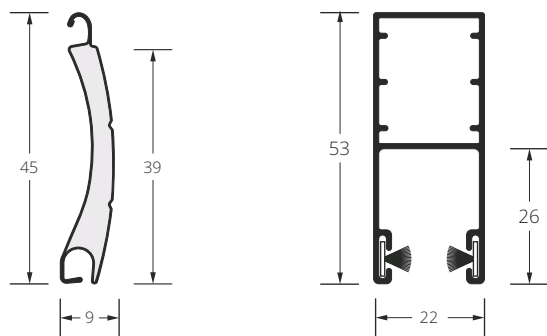

* RAL numbers mean the colours similar to real, the most reliable way to verify is our colour sampler.

1. - longer realization term.
2. - painting surcharge, longer realization term.
3. - in the size 205 mm the box is not available.
4. - minimum order is 15 m².

Colour	symbol	RAL*	Curtain profile	Box SK45	End slat	Guide PP53	Box OWAL	Box SKP	Guide PK53	Guide PPMO	Distance D/PP	Guide PP68		
silver	01	9006	✓	✓	✓	✓	1	1	✓	✓	✓	✓	standard colours	
white	02	9016	✓	✓	✓	✓	1	1	✓	✓	✓	✓		
grey	03	7038	✓	✓	✓	✓	1	1	✓	2	✓	✓		
dark beige	04	1019	✓											
beige	05	1013	✓	✓	✓	✓			✓		✓	✓		
dark brown	08	8019	✓	✓	✓	✓	1	1	✓	✓	✓	✓		
brown	09	8014	✓	✓	✓	✓	1	1	✓	2	✓	✓		
crème white	15	9001	✓	1	✓	✓	1		1					
ivory	16	1015	✓	2	2	2	2	2	2	2	2	2		
ultra white	22		1	1	✓	✓	1		1		1	1		
anthracite grey	23	7016	✓	✓	✓	✓	1	1	✓	✓	✓	✓		
light grey	31	7047	✓	2	2	2	2	2	2	2	2	2		
dark wood	06		1											woodlike (surcharge)
light wood	07		1											
mahogany	26		✓	3										
walnut	28		✓	✓	✓	✓			✓	✓		✓		
golden oak	30		✓	✓	✓	✓			✓	✓		✓		
swamp oak	36		✓											
winchester	52		✓											
light oak	79		✓											
mahogany	26R				✓	✓			✓		✓	✓	woodlike foil renolite (surcharge)	
walnut	28R				✓	✓			✓		✓	✓		
golden oak	30R			1	✓	✓			✓			✓		
swamp oak	36R			1	✓	✓			✓					
winchester	52R			1	✓	✓			✓					
light oak	79R				1	1							PP53 PVC woodlike veneer RENOLIT (extra charge)	
alux db PVC	46F					1								
brushed aluminium PVC	47F					1								
light silver PVC	48F					1								
sheffield oak light PVC	49F					1								
sheffield oak alpine PVC	50F					1								
sheffield oak concreto PVC	51F					1								
turner oak PVC	52F					1								
jet black matt PVC	53F					1								
red	12	3003	4	2	2	2	2	2	2	2	2	2		non-standard (surcharge)
green	13	6005	4	2	2	2	2	2	2	2	2	2		
fir green	17	6009	4	2	2	2	2	2	2	2	2	2		
steel blue	18	5011	4	2	2	2	2	2	2	2	2	2		
burgundy	19	3005	4	2	2	2	2	2	2	2	2	2		
black	20	9005	1	2	✓	2	2	2	2	2	2	2		
basalt grey	33	7012	✓	2	2	2	2	2	2	2	2	2		
quartz grey	34	7039	✓	✓	✓	✓	1	2	2	2	2	2		
concrete grey	35	7023	4	2	2	2	2	2	2	2	2	2		
grey aluminum	37	9007	1	2	2	2	2	2	2	2	2	2		
white pearl matt	40		4		1	1			1		1			
light grey pearl matt	41				2	1			1		1			
grey pearl matt	42				2	1			1		1			
anthracite grey pearl matt	43		1		1	1			1		1			
dark grey pearl matt	44				2	1			1		1			



Price list for SK45⁰, Oval*, SKP* roller shutters in standard colour, PA39 profile

Net prices in EUR

Box with Ø60 pipe	Box with Ø40 pipe	Width Height	Net prices in EUR																													
			500	600	700	800	900	1000	1100	1200	1300	1400	1500	1600	1700	1800	1900	2000	2100	2200	2300	2400	2500	2600	2700	2800	2900	3000	3100	3200		
137	137	500	73	76	80	83	86	90	92	154	100	103	106	109	113	119	124	129	134	138	144	148	154	159	164	170	174	180	184	190		
		600	76	80	83	87	90	94	97	100	106	109	113	116	125	132	136	142	148	153	160	165	171	176	182	187	193	198	203	209		
		700	80	83	87	90	94	98	103	106	111	115	125	131	136	144	150	155	161	167	174	181	187	193	199	205	211	217	222	228		
		800	81	86	91	96	100	105	109	113	124	131	137	144	151	159	166	172	180	186	194	200	208	214	221	228	234	241	248	255		
		900	86	91	96	101	106	111	115	127	135	143	150	158	166	174	182	189	197	204	212	220	228	234	241	249	256	263	270	277		
		1000	89	94	100	105	109	115	127	135	145	153	161	170	177	186	194	203	211	219	228	237	247	256	265	274	284	292	302	311	319	329
		1100	93	98	105	109	115	128	137	146	155	165	174	183	192	202	210	219	228	237	247	256	265	274	284	292	302	311	319	329		
150	150	1200	96	102	107	114	126	135	145	155	165	175	184	194	203	214	223	233	242	252	263	272	282	292	302	311	321	331	341	351		
		1300	105	113	121	133	145	155	167	179	191	202	214	225	237	249	261	272	283	294	306	318	330	341	353	364	376	387	399	410		
		1400	109	116	124	140	151	164	176	187	200	212	224	237	249	261	273	285	298	309	322	334	346	358	370	382	394	405	418	430		
		1500	112	121	134	147	160	173	185	198	212	224	237	250	263	277	289	303	315	327	341	354	367	380	393	406	419	432	445	458		
		1600	116	126	143	157	170	183	197	210	225	239	252	266	279	294	307	320	334	347	362	375	389	403	417	431	444	458	472	486		
165	150	1700	120	134	149	163	177	191	205	219	234	249	263	277	290	306	320	334	348	363	378	392	405	420	434	449	462	477	491	505		
		1800	125	141	155	171	185	200	215	230	246	261	276	290	305	321	336	351	366	381	395	411	426	441	457	471	486	501	516	531		
		1900	128	143	162	178	193	209	225	240	257	273	288	304	319	337	352	367	383	399	415	431	447	462	478	492	508	524	539			
180	165	2000	135	151	167	184	200	217	234	250	268	284	300	317	333	351	367	383	400	417	434	450	467	484	501	518	536	553				
		2100	139	156	173	190	208	224	241	259	277	294	311	328	345	363	380	397	414	431	449	466	484	502	519	537						
		2200	144	162	180	198	215	234	251	269	288	306	324	342	359	378	395	414	432	450	469	486	504	522	540							
		2300	148	167	186	204	223	241	260	278	298	316	334	353	372	391	409	427	446	464	484	502	521	540								
205	180	2400	154	173	193	211	231	250	269	289	308	328	347	366	385	405	425	444	463	482	502	522	541									
		2500	161	182	202	222	241	262	281	302	322	343	363	383	402	423	444	463	484	503	525	544										
		2600	166	187	209	229	250	271	292	312	334	354	375	396	417	439	459	480	501	522	543											
		2700	171	193	214	235	257	278	300	321	343	365	386	407	429	451	473	495	515	536												
205	205	2800	176	199	221	243	265	287	309	332	354	377	399	421	443	466	489	511	533													
		2900	181	203	227	251	272	295	318	340	364	386	410	432	455	479	501	524														
		3000	185	209	232	258	279	302	326	349	373	396	420	443	467	491	514	537														

Winding pipe Ø40 ← → Winding pipe Ø60

Surcharges:	Winding pipe Ø40 ← → Winding pipe Ø60																											
Woodlike box	5	6	7	8	9	11	12	13	14	15	16	17	18	19	20	21	22	23	24	25	26	27	28	29	30	32	33	34
Woodlike box RENOLIT	28	34	40	45	51	57	62	68	74	79	85	91	96	102	108	114	119	125	131	136	142	148	153	159	165	170	176	182
Woodlike end slat	4	5	5	6	7	8	8	9	10	11	11	12	13	14	14	15	16	17	17	18	19	20	20	21	22	23	23	24
Woodlike end slat RENOLIT	4	5	6	7	8	9	9	10	11	12	13	14	14	15	16	17	18	19	20	20	21	22	23	24	25	26	26	27
Block hangers	2 pieces / 18 €							3 pieces / 27 €							4 pieces / 36 €							5 pieces / 45 €						

Standard equipment includes:

- box cut at an angle of 45° in sizes customized to the height of the roller shutter.
- a winding pipe (shaft) with a diameter of 40 or 60 mm, depending on the dimensions of the roller shutter.
- Pa 39 profile, perforated, standard colour.
- manual control for cord - white box coiler, up to 12 kg.
- 56 mm high end slat with a rubber seal.
- 53 mm guides, standard colour.
- end caps for guide mounting holes.
- steel hangers.
- stopper.
- packing: box with bubble wrap, guides with stretch wrap.

For an extra charge or optional (no information on order form means that the standard will be produce):

- manual control by tape (no surcharge) 0 € pcs.
- box coiler for cord in brown (no surcharge) 0 € pcs.
- anthracite box coiler with gray cord 0 € pcs.
- box coiler for tape in brown or anthracite (no surcharge) 0 € pcs.
- drilling holes in guides (no surcharge) 0 € pcs.
- cable extraction outside the box (no surcharge) 0 € pcs.
- rotating plug instead of buffers (no surcharge) 0 € set
- curtain profile without perforation 0 € pcs.
- bottom end cap of the PP53 guides 0 € set
- packing in corrugated cardboard 4 € rm
- packing in a 6 mm thick cardboard 15 € rm
- packing the box and the curtain profile separately 15 € rm
- OWAL* or SKP* box 5% pcs.
- winder crank for cord or tape up to 20 kg 30 € set
- the box varnishing 40 € pcs.
- the guides varnishing 25 € set
- the end slat varnishing 15 € pcs.
- surcharge to curtain profile - woodlike colour 5 € m²
- surcharge to curtain profile - non-standard colour 8 € m²
- automatic lock (only roller shutters without motor) 30 € set
- manual fastening (only roller shutters without motor) 22 € / set
- spring 10 kg Ø 40 + cylinder lock 94 € set
- spring 15 kg Ø 40 + cylinder lock 106 € set
- spring 15 kg Ø 60 + cylinder lock 112 € set
- spring 24 kg Ø 60 + cylinder lock 115 € set
- rolling insect screen (max 1600 mm wide and 2400 mm high) 65 € m²
- (using a rolling insect screen increases the size of the box)
- drive selected according to legend, drives prices on pages 50 - 57.
- remote control with the appropriate number of channels, prices on pages 50 - 57.
- push-button switch selectable on pages 50 - 57

Surcharge for guides					
PP53 (2 pcs.)	PP53 (2 pcs.)	PP53 PVC (2 pcs.)	PK53 PPMO PP68 (1 pcs.)	PK53 PPMO PP68 (1 pcs.)	PK53 PP68 (1 pcs.)
woodlike VARNISH	woodlike RENOLIT	woodlike RENOLIT	standard colour	woodlike VARNISH	woodlike RENOLIT
2	4	6	3	9	12
3	5	8	3	9	13
3	6	9	4	10	13
3	7	10	4	10	14
4	8	11	5	11	14
4	9	13	6	11	15
5	9	14	6	12	15
5	10	15	7	12	16
6	11	16	7	13	16
6	12	18	8	13	17
6	13	19	8	14	18
7	14	20	9	15	18
7	14	21	9	15	19
8	15	23	10	16	19
8	16	24	10	16	20
9	17	25	11	17	20
9	18	26	12	17	21
9	19	28	12	18	21
10	20	29	13	18	22
10	20	30	13	19	22
11	21	31	14	20	23
11	22	33	14	20	24
11	23	34	15	21	24
12	24	35	15	21	25
12	25	36	16	22	25
13	26	38	17	22	26

Specification

- 10 Nm short Ø 40 motor
- 10 Nm Ø 40 motor
- 13 Nm Ø 40 motor
- 13 Nm Ø 60 motor
- 23 Nm Ø 60 motor





Price list for SK45⁰ roller shutters, woodlike colour, PA39 profile

Net prices in EUR

Box with Ø60 pipe	Box with Ø40 pipe	Width Height	Net prices in EUR																											
			500	600	700	800	900	1000	1100	1200	1300	1400	1500	1600	1700	1800	1900	2000	2100	2200	2300	2400	2500	2600	2700	2800	2900	3000	3100	3200
137	137	500	83	89	94	99	104	109	115	120	126	131	137	142	147	154	161	167	174	182	188	196	202	208	213	219	225	231	237	243
		600	87	93	98	103	109	115	121	126	132	138	144	149	160	167	175	182	190	197	205	212	220	227	234	241	248	255	263	269
		700	90	96	103	108	114	121	126	132	139	145	156	164	172	181	189	197	205	213	222	229	238	246	255	263	271	279	288	296
		800	95	102	108	114	121	127	134	140	153	161	170	179	188	197	206	215	223	232	242	251	260	268	277	286	295	303	312	320
		900	99	106	113	119	126	132	139	153	163	172	182	192	200	211	220	229	239	249	259	268	277	287	297	306	315	325	334	344
		1000	103	111	118	125	132	140	154	164	175	185	196	206	216	228	237	247	257	268	279	289	299	309	319	330	340	351	361	371
		1100	107	115	122	130	137	152	163	174	185	196	207	218	229	240	251	262	273	284	295	306	317	327	338	348	359	370	381	392
		1200	112	120	128	135	151	162	174	185	198	210	221	233	244	257	268	280	292	303	315	327	339	352	364	376	388	400	412	425
165	165	1300	116	125	133	147	160	172	184	197	210	222	235	247	260	273	285	298	310	322	336	348	361	373	386	399	411	424	437	450
		1400	120	129	138	155	167	180	193	207	220	233	246	260	272	287	299	313	325	338	353	365	378	392	405	419	432	446	459	472
		1500	124	134	149	163	177	190	204	218	233	246	261	274	288	303	316	330	344	358	373	386	400	414	428	442	456	469	483	497
		1600	128	141	158	173	188	203	218	233	248	263	278	293	308	324	338	353	368	383	399	413	428	443	458	473	488	503	518	533
		1700	133	149	165	180	196	211	227	242	258	274	289	305	320	337	353	367	383	399	415	431	446	462	477	492	508	523	538	554
		1800	140	155	172	188	205	221	237	254	271	287	303	319	335	353	369	385	401	418	435	451	468	484	500	516	532	549	565	581
		1900	144	161	179	196	212	229	246	263	281	298	315	331	348	366	383	400	417	434	451	469	486	502	519	537	554	570	588	
		2000	151	169	186	203	221	239	257	274	293	311	328	346	364	383	400	418	436	453	471	489	507	525	543	561	578	596		
180	180	2100	156	174	193	211	229	247	266	284	303	321	340	358	377	395	414	432	450	469	488	506	525	543	561	579				
		2200	161	181	200	219	238	257	276	295	315	334	354	373	392	412	431	450	469	488	508	527	546	565	584					
		2300	167	186	206	226	246	266	285	305	326	346	365	385	405	425	445	464	484	504	525	544	564	584						
		2400	173	193	214	234	255	276	296	316	338	358	379	399	420	442	462	482	502	524	545	565	586							
205	205	2500	179	200	221	242	263	285	306	328	350	372	393	414	435	457	479	500	521	543	565	586								
		2600	184	206	228	250	272	293	315	337	360	382	404	426	448	471	492	514	537	558	582									
		2700	190	212	235	258	280	303	326	348	372	395	418	440	463	487	510	532	555	577										
		2800	195	218	241	265	288	311	335	358	383	406	429	452	476	501	524	547	570											
205	205	2900	200	225	249	273	297	321	346	370	395	419	443	467	491	517	540	565												
		3000	207	232	257	281	306	331	356	381	407	431	457	482	507	533	557	583												

Surcharge for guides			
PK53 PPMO PP68	PK53 PP68	PP53	PP53 PVC
woodlike VARNISH (for 1 pcs.)	woodlike RENOLIT (for 1 pcs.)	woodlike RENOLIT (for 2 pcs.)	woodlike RENOLIT (for 2 pcs.)
4	5	2	4
5	6	3	5
6	7	3	6
7	8	3	7
8	9	4	7
9	10	4	8
9	11	5	9
10	12	5	10
11	13	6	11
12	14	6	12
13	15	6	12
14	16	7	13
14	17	7	14
15	18	8	15
16	19	8	16
17	20	9	17
18	21	9	17
19	22	9	18
20	23	10	19
20	24	10	20
21	25	11	21
22	26	11	21
23	27	11	22
24	28	12	23
25	29	12	24
26	30	13	25

Surcharges:	Winding pipe Ø40														Winding pipe Ø60													
Woodlike box RENOLIT	23	28	32	37	42	46	51	56	60	65	69	74	79	83	88	93	97	102	106	111	116	120	125	130	134	139	143	148
Woodlike end slat RENOLIT	1	1	1	1	1	2	2	2	2	2	2	2	2	3	3	3	3	3	3	3	4	4	4	4	4	5	5	5
Block hangers	2 pieces / 18 €					3 pieces / 27 €					4 pieces / 36 €					5 pieces / 45 €												

Specification

- 10 Nm short Ø 40 motor
- 10 Nm Ø 40 motor
- 13 Nm Ø 40 motor
- 13 Nm Ø 60 motor
- 23 Nm Ø 60 motor

Standard equipment includes:

- a box cut at an angle of 45° in sizes customized to the height of the roller shutter varnished in woodlike colour.
- a winding pipe (shaft) with a diameter of 40 or 60 mm, depending on the dimensions of the roller shutter.
- profile Pa 39 perforated, woodlike colour.
- manual control for cord - white box coiler, up to 12 kg.
- 56 mm end slat varnished in woodlike colour with a rubber seal.
- 53 mm woodlike guides, varnished.
- end caps for guide mounting holes.
- steel hangers.
- stopper.
- packing: box with bubble wrap, guides with stretch wrap.

For an extra charge or optional (no information on order form means that the standard will be produce):

- manual control by tape (no surcharge) 0 € pcs.
- box coiler for cord in brown (no surcharge) 0 € pcs.
- anthracite box coiler with gray cord 0 € pcs.
- box coiler for tape in brown or anthracite (no surcharge) 0 € pcs.
- drilling holes in guides (no surcharge) 0 € pcs.
- cable extraction outside the box (no surcharge) 0 € pcs.
- rotating plug instead of buffers (no surcharge) 0 € set
- bottom end cap of the PP53 guides 0 € set
- packing in corrugated cardboard 4 € rm
- packing in a 6 mm thick cardboard 15 € rm
- packing the box and the curtain profile separately 15 € rm
- winder crank for a cord or tape up to 20 kg 30 € set
- automatic lock (only roller shutters without motor) 30 € set
- manual fastening (only roller shutters without motor) 22 € / set
- spring 10 kg Ø 40 + cylinder lock 94 € set
- spring 15 kg Ø 40 + cylinder lock 106 € set
- spring 15 kg Ø 60 + cylinder lock 112 € set
- spring 24 kg Ø 60 + cylinder lock 115 € set
- rolling insect screen (max 1600 mm wide and 2400 mm high) 65 € m² (max 1600 mm wide and 2400 mm high) (using a rolling insect screen increases the size of the box)
- drive selected according to legend, drives prices on pages 50 - 57.
- remote control with the appropriate number of channels, prices on pages 50 - 57.
- push-button switch selectable on pages 50 - 57

WARNING! in mahogany, swamp oak, winchester - guides, end slat and box are not available in the varnished version, extra charge for RENOLIT should be added.



Price list for SK45⁰, Oval *, SKP * roller shutters in a non-standard colour, PA39 profile

Net prices in EUR

Box with Ø60 pipe	Box with Ø40 pipe	Width Height	500	600	700	800	900	1000	1100	1200	1300	1400	1500	1600	1700	1800	1900	2000	2100	2200	2300	2400	2500	2600	2700	2800	2900	3000	3100	3200
137	137	500	109	115	122	128	135	142	150	156	164	171	177	183	190	200	210	217	227	236	245	254	262	270	277	285	293	301	308	316
		600	113	120	127	135	142	150	157	164	172	179	187	194	207	218	228	237	246	257	267	276	286	295	304	313	323	332	341	350
		700	118	125	133	141	149	157	164	172	180	188	203	213	223	236	246	257	266	277	289	298	309	320	331	342	353	363	374	385
		800	124	132	140	149	157	166	174	182	199	210	221	233	244	257	269	279	290	302	314	326	338	349	360	372	383	394	406	416
		900	128	137	146	155	164	172	181	199	212	224	237	249	261	274	286	298	311	323	336	348	361	373	386	398	410	423	435	447
		1000	135	144	153	162	172	182	200	213	228	241	254	268	280	296	308	321	335	348	362	376	389	402	415	429	442	456	469	483
		1100	140	150	159	169	178	198	211	226	241	255	270	284	297	313	326	341	354	369	384	398	412	426	440	453	467	481	495	509
150	150	1200	145	155	166	176	196	211	226	241	257	272	287	303	317	333	348	364	379	394	410	425	441	457	473	489	504	521	536	552
		1300	151	161	173	191	208	223	240	256	273	289	305	321	338	354	371	387	404	419	437	452	469	486	502	519	535	551	568	584
		1400	156	167	179	201	217	235	251	269	286	303	320	338	354	373	389	407	423	440	458	474	492	509	527	544	562	579	597	614
165	150	1500	161	174	194	211	229	248	265	284	303	320	339	356	374	394	411	429	447	465	485	502	520	538	556	574	592	610	628	646
		1600	167	183	205	224	244	263	284	303	322	342	361	381	400	421	440	459	478	498	519	537	556	576	596	615	634	654	674	693
		1700	173	194	215	235	254	274	295	314	336	356	376	396	416	438	458	478	498	519	540	560	580	600	620	640	660	680	700	720
		1800	182	203	223	245	266	287	308	330	352	373	394	415	436	459	480	501	522	543	566	587	608	629	650	671	692	713	735	756
		1900	188	210	232	254	276	297	320	342	365	387	409	431	452	476	498	520	542	564	587	609	631	653	675	697	720	741	764	
180	165	2000	196	219	242	264	287	311	333	357	381	404	427	450	473	497	520	543	566	588	613	636	659	683	706	729	752	775		
		2100	203	226	251	274	297	321	346	369	394	417	442	465	490	514	538	562	585	610	634	658	682	706	729	753				
		2200	210	235	259	285	310	334	360	384	410	435	459	485	509	535	560	585	610	634	661	685	710	735	759					
		2300	217	242	269	294	320	346	371	396	424	449	474	500	526	553	578	603	629	655	682	708	733	759						
205	180	2400	224	251	278	304	331	359	384	411	439	465	492	519	546	574	601	627	653	681	708	735	761							
		2500	232	259	287	315	343	371	398	426	456	483	511	538	566	595	622	650	678	706	735	762								
		2600	239	268	296	325	353	381	410	439	469	497	525	554	583	612	640	669	698	726	756									
		2700	247	276	306	335	365	394	424	453	484	513	543	573	602	633	663	692	722	751										
		2800	253	284	314	345	375	405	436	465	497	528	558	588	619	651	681	710	741											
205	205	2900	261	292	324	355	387	417	449	480	513	544	576	607	639	672	702	735												
		3000	269	301	333	365	398	431	462	496	529	561	595	627	659	693	725	758												

Winding pipe Ø40 ← → Winding pipe Ø60

Surcharges:	
Block hangers	2 pieces / 18 € 3 pieces / 27 € 4 pieces / 36 € 5 pieces / 45 €

Surcharge for guides	
PK53 PPMO PP68 non-standard colour (for 1 pcs.)	
4	
4	
5	
6	
7	
7	
9	
9	
10	
11	
12	
12	
13	
14	
15	
15	
16	
17	
17	
18	
19	
20	
20	
21	
22	

Specification	
- 10 Nm short Ø 40 motor	□
- 10 Nm Ø 40 motor	▒
- 13 Nm Ø 40 motor	▓
- 13 Nm Ø 60 motor	■
- 23 Nm Ø 60 motor	■

Standard equipment includes:

- a box cut at an angle of 45° in sizes customized to the height of the roller shutter in the colour of the guides and the end slat, similar to the colour of curtain profile.
- a winding pipe (shaft) with a diameter of 40 or 60 mm, depending on the dimensions of the roller shutter.
- Pa 39 profile, perforated, non-standard colour.
- manual control for cord - box coiler in white.
- 56 mm high end slat with a rubber seal.
- 53 mm guides in the colour of box and end slat, similar to the colour of curtain profile.
- end caps for guide mounting holes.
- steel hangers.
- stopper.
- packing: box with bubble wrap, guides with stretch wrap.

For an extra charge or optional (no information on order form means that the standard will be produce):

- | | | | |
|---|----------|--|---------------------|
| - manual control by tape (no surcharge) | 0 € pcs. | - automatic lock (only roller shutters without motor) | 30 € set |
| - box coiler for cord in brown (no surcharge) | 0 € pcs. | - manual fastening (only roller shutters without motor) | 22 € / set |
| - anthracite box coiler with gray cord | 0 € pcs. | - spring 10 kg Ø 40 + cylinder lock | 94 € set |
| - box coiler for tape in brown or anthracite (no surcharge) | 0 € pcs. | - spring 15 kg Ø 40 + cylinder lock | 106 € set |
| - drilling holes in guides (no surcharge) | 0 € pcs. | - spring 15 kg Ø 60 + cylinder lock | 112 € set |
| - cable extraction outside the box (no surcharge) | 0 € pcs. | - spring 24 kg Ø 60 + cylinder lock | 115 € set |
| - rotating plug instead of buffers (no surcharge) | 0 € set | - rolling insect screen (max 1600 mm wide and 2400 mm high) | 65 € m ² |
| - bottom end cap of the PP53 guides | 0 € set | (max 1600 mm wide and 2400 mm high) | |
| - packing in corrugated cardboard | 4 € rm | (using a rolling insect screen increases the size of the box) | |
| - packing in a 6 mm thick cardboard | 15 € rm | - drive selected according to legend, drives prices on pages 50 - 57. | |
| - packing the box and the curtain profile separately | 15 € rm | - remote control with the appropriate number of channels, prices on pages 50 - 57. | |
| - OWAL* or SKP* box | 5% pcs. | - push-button switch selectable on pages 50 - 57 | |
| - winder crank for cord or tape up to 20 kg | 30 € set | | |
- WARNING!** colours of end caps and stoppers may significantly differ from other elements colour due to their limited colours.

Price list for external roller shutters - SK45⁰ / Oval / SKP system on 43 mm aluminum profile

- aluminum box cut at an angle of 45 degrees "SK 45" or - with extra charge - rounded "Oval" or semi-circular "SKP".
- 53 mm wide aluminum guides straight or - with extra charge - PK53, PPMO.
- 43 mm aluminum profile filled with polyurethane foam (weight 2.6 kg / m²).
- maximum dimensions: width 3300 mm, height 3800 mm (for 1 class wind resistance according to EN13659).
- manual drive in the form of a box coiler for cord or tape (maximum weight for curtain: up to 12 kg).
- maximum roller shutter surface 9 m².
- recommended by the system provider stability for the curtain is obtained for surface up to 7 m². Above this value slight undulations of the curtain may occur - however, this does not affect functionality and roller shutter fulfills all criteria specified by the norm.



SK45



Oval



SKP

43 mm „PA-43“ aluminum profile.

"PP-53" guide.

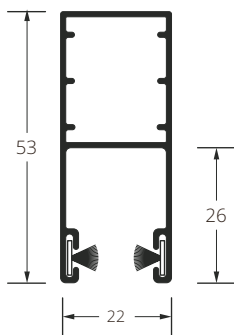
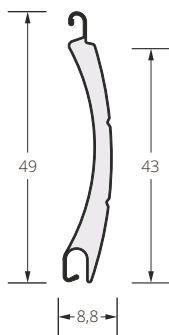

* RAL numbers mean the colours similar to real, the most reliable way to verify is our colour sampler.

1. - longer realization term.
2. - painting surcharge, longer realization term.
3. - in the size 205 mm the box is not available.
4. - minimum order is 15 m².

Colour	symbol	RAL*	Curtain profile	Box SK45	End slat	Guide PP53	Box OWAL	Box SKP	Guide PK53	Guide PPMO	Distance D/PP	Guide PP68	
silver	01	9006	✓	✓	✓	✓	1	1	✓	✓	✓	✓	standard colours
white	02	9016	✓	✓	✓	✓	1	1	✓	✓	✓	✓	
grey	03	7038	✓	✓	✓	✓	1	1	✓	2	✓	✓	
dark beige	04	1019	4										
beige	05	1013	✓	✓	✓	✓			✓		✓	✓	
dark brown	08	8019	✓	✓	✓	✓	1	1	✓	✓	✓	✓	
brown	09	8014	✓	✓	✓	✓	1	1	✓	2	✓	✓	
crème white	15	9001	✓	1	✓	✓	1		1				
ivory	16	1015	✓	2	2	2	2	2	2	2	2	2	
ultra white	22		1	1	✓	✓	1		1		1	1	
anthracite grey	23	7016	✓	✓	✓	✓	1	1	✓	✓	✓	✓	
light grey	31	7047	✓	2	2	2	2	2	2	2	2	2	
dark wood	06		4										
mahogany	26		✓	3									
walnut	28		✓	✓	✓	✓			✓	✓		✓	
golden oak	30		✓	✓	✓	✓			✓	✓		✓	
swamp oak	36		✓									✓	
winchester	52		✓										woodlike foil renolite (surcharge)
mahogany	26R				✓	✓			✓		✓		
walnut	28R				✓	✓			✓		✓	✓	
golden oak	30R			1	✓	✓			✓		✓	✓	
swamp oak	36R			1	✓	✓			✓				
winchester	52R			1	✓	✓			✓				PP53 PVC woodlike veneer RENOLIT (extra charge)
light oak	79R				1	1							
alux db PVC	46F					1							
brushed aluminium PVC	47F					1							
light silver PVC	48F					1							
sheffield oak light PVC	49F					1							
sheffield oak alpine PVC	50F					1							
sheffield oak concrete PVC	51F					1							
turner oak PVC	52F					1							
jet black matt PVC	53F					1							
red	12	3003		2	2	2	2	2	2	2	2	2	non-standard (surcharge)
green	13	6005		2	2	2	2	2	2	2	2	2	
fir green	17	6009		2	2	2	2	2	2	2	2	2	
steel blue	18	5011		2	2	2	2	2	2	2	2	2	
burgundy	19	3005		2	2	2	2	2	2	2	2	2	
black	20	9005	1	2	✓	2	2	2	2	2	2	2	
basalt grey	33	7012	✓	2	2	2	2	2	2	2	2	2	
quartz grey	34	7039	✓	✓	✓	✓	1	2	2	2	2	2	
concrete grey	35	7023	4	2	2	2	2	2	2	2	2	2	
grey aluminum	37	9007	1	2	2	2	2	2	2	2	2	2	
white pearl matt	40				1	1			1		1		
light grey pearl matt	41				2	1			1		1		
grey pearl matt	42				2	1			1		1		
anthracite grey pearl matt	43				1	1			1		1		
dark grey pearl matt	44				2	1			1		1		



Price list for SK45⁰, Oval *, SKP * roller shutters in standard colour, PA43 profile

Net prices in EUR

Box with Ø60 pipe	Box with Ø40 pipe	Width Height	Net prices in EUR																												
			500	600	700	800	900	1000	1100	1200	1300	1400	1500	1600	1700	1800	1900	2000	2100	2200	2300	2400	2500	2600	2700	2800	2900	3000	3100		
137	137	500	76	80	85	88	92	97	100	102	109	113	117	120	125	132	137	143	148	154	160	165	171	177	183	189	194	200	206		
		600	80	85	89	93	97	103	106	109	116	121	125	130	139	147	152	159	165	171	179	184	191	197	204	210	217	223	229		
		700	85	89	93	98	103	108	113	118	124	128	139	146	153	161	168	175	182	189	197	204	211	218	225	232	239	246	252		
		800	87	93	99	105	109	116	121	126	138	146	154	162	170	179	186	195	203	210	219	228	235	243	251	259	267	274	282		
		900	93	98	105	111	116	123	129	142	151	160	169	178	187	197	205	214	223	231	241	250	258	267	275	284	292	300	308		
		1000	96	103	109	116	122	129	142	152	163	172	182	191	200	211	220	230	240	250	260	269	279	289	299	309	319	330	340		
150	150	1100	100	107	115	122	129	143	154	164	176	186	197	207	218	229	239	250	260	270	282	292	303	314	324	335	346	356	367		
		1200	104	112	119	126	141	152	163	175	187	199	210	220	232	244	255	267	277	288	301	311	323	335	346	358	370	381	393		
		1300	114	124	133	147	161	174	187	200	214	228	241	254	267	281	295	308	321	334	348	361	375	388	401	414	428	441	454		
		1400	119	128	137	155	169	183	197	211	226	240	254	267	281	296	309	324	338	352	367	381	394	408	422	436	450	463	478		
		1500	124	133	149	164	179	193	208	223	239	254	268	283	298	314	329	344	359	373	389	404	419	434	449	464	479	495	509		
		1600	129	140	159	174	190	205	222	237	254	270	285	301	317	334	349	365	381	396	413	428	444	460	476	492	508	525	540		
165	165	1700	134	148	165	182	198	215	231	248	265	281	298	314	330	348	365	382	398	414	431	447	464	481	497	514	530	547	564		
		1800	139	155	173	190	208	225	242	260	278	295	313	330	347	366	383	401	418	435	452	471	488	506	524	541	558	576	594		
		1900	143	159	180	199	217	235	254	272	291	309	327	346	364	384	402	420	438	457	476	495	512	530	548	566	584	603	621		
		2000	148	167	186	206	226	244	264	283	304	322	342	361	380	400	420	439	458	478	497	517	536	556	576	595	615	635	655		
		2100	154	173	193	214	234	254	273	293	314	334	354	374	394	415	435	455	475	495	516	536	556	577	597	618	639	660	680		
		2200	159	180	202	222	243	264	285	306	328	348	369	391	411	433	453	475	496	516	538	559	580	601	623	644	665	685	707		
180	180	2300	165	186	208	229	251	273	295	316	339	360	382	404	425	448	469	491	513	534	557	578	600	623	645	667	690	711	733		
		2400	171	193	216	238	261	283	306	328	352	374	397	420	442	465	488	510	533	555	579	601	623	646	668	691	713	735	757		
		2500	179	202	226	250	272	296	319	343	367	391	414	438	461	486	509	533	556	579	604	627	651	674	697	720	742	766	789		
		2600	184	209	233	258	282	307	331	355	381	405	429	453	478	503	528	552	576	601	626	651	677	702	727	752	778	803	828		
		2700	190	215	240	265	290	315	341	366	392	417	442	467	492	518	545	572	598	624	651	678	704	730	757	783	810	836	863		
		2800	196	222	248	274	300	326	352	378	405	431	457	483	509	536	563	589	616	643	670	697	724	751	777	804	831	858	885		
205	205	2900	200	228	255	282	308	335	362	388	415	443	470	497	523	550	578	606	634	661	689	717	744	771	799	827	855	882	910		
		3000	206	234	261	291	316	343	372	399	427	454	482	509	537	565	594	621	649	678	706	733	761	789	817	845	874	902			

Winding pipe Ø40 ← → Winding pipe Ø60

Surcharges:	Winding pipe Ø40 ← → Winding pipe Ø60																																
Woodlike box	5	6	7	8	9	11	12	13	14	15	16	17	18	19	20	21	22	23	24	25	26	27	28	29	30	32	33						
Woodlike box RENOLIT	28	34	40	45	51	57	62	68	74	79	85	91	96	102	108	114	119	125	131	136	142	148	153	159	165	170	176						
Woodlike end slat	4	5	5	6	7	8	8	9	10	11	11	12	13	14	14	15	16	17	17	18	19	20	20	21	22	23	23						
Woodlike end slat RENOLIT	4	5	6	7	8	9	9	10	11	12	13	14	14	15	16	17	18	19	20	20	21	22	23	24	25	26	26						
Block hangers	2 pieces / 18 €							3 pieces / 27 €							4 pieces / 36 €							5 pieces / 45 €											

Standard equipment includes:

- box cut at an angle of 45° in sizes customized to the height of the roller shutter.
- a winding pipe (shaft) with a diameter of 40 or 60 mm, depending on the dimensions of the roller shutter.
- Pa 43 profile, perforated, standard colour
- manual control for cord - box coiler in white.
- 56 mm high end slat with a rubber seal.
- 53 mm guides, standard colour.
- end caps for guide mounting holes.
- steel hangers.
- stopper.
- packing: box with bubble wrap, guides with stretch wrap.

For an extra charge or optional (no information on order form means that the standard will be produce):

- manual control by tape (no surcharge) 0 € pcs.
- box coiler for cord in brown (no surcharge) 0 € pcs.
- anthracite box coiler with gray cord 0 € pcs.
- box coiler for tape in brown or anthracite (no surcharge) 0 € pcs.
- drilling holes in guides (no surcharge) 0 € pcs.
- cable extraction outside the box (no surcharge) 0 € pcs.
- rotating plug instead of buffers (no surcharge) 0 € set
- curtain profile without perforation (no surcharge) 0 € pcs.
- bottom end cap of the PP53 guides 0 € set
- packing in corrugated cardboard 4 € rm
- packing in a 6 mm thick cardboard 15 € rm
- packing the box and the curtain profile separately 15 € rm
- OWAL* or SKP* box 5% pcs.
- winder crank for cord or tape up to 20 kg 30 € set
- the box varnishing 40 € pcs.
- the guides varnishing 25 € set
- the end slat varnishing 15 € pcs.
- surcharge to curtain profile - woodlike colour 7 € m²
- surcharge to curtain profile - non-standard colour 10 € m²
- automatic lock (only roller shutters without motor) 30 € set
- manual fastening (only roller shutters without motor) 22 € / set
- spring 10 kg Ø 40 + cylinder lock 94 € set
- spring 15 kg Ø 40 + cylinder lock 106 € set
- spring 15 kg Ø 60 + cylinder lock 112 € set
- spring 24 kg Ø 60 + cylinder lock 115 € set
- rolling insect screen (max 1600 mm wide and 2400 mm high) 65 € m²
- (using a rolling insect screen increases the size of the box)
- drive selected according to legend, drives prices on pages 50 - 57.
- remote control with the appropriate number of channels, prices on pages 50 - 57.
- push-button switch selectable on pages 50 - 57

Surcharge for guides					
PP53 (2 pcs.)	PP53 (2 pcs.)	PP53 PVC (2 pcs.)	PK53 PPMO PP68 (1 pcs.)	PK53 PPMO PP68 (1 pcs.)	PK53 PP68 (1 pcs.)
woodlike VARNISH	woodlike RENOLIT	woodlike RENOLIT	standard colour	woodlike VARNISH	woodlike RENOLIT
2	4	6	3	9	12
3	5	8	3	9	13
3	6	9	4	10	13
3	7	10	4	10	14
4	8	11	5	11	14
4	9	13	6	11	15
5	9	14	6	12	15
5	10	15	7	12	16
6	11	16	7	13	16
6	12	18	8	13	17
6	13	19	8	14	18
7	14	20	9	15	18
7	14	21	9	15	19
8	15	23	10	16	19
8	16	24	10	16	20
9	17	25	11	17	20
9	18	26	12	17	21
9	19	28	12	18	21
10	20	29	13	18	22
10	20	30	13	19	22
11	21	31	14	20	23
11	22	33	14	20	24
11	23	34	15	21	24
12	24	35	15	21	25
12	25	36	16	22	25
13	26	38	17	22	26

Specification

- 10 Nm short Ø 40 motor
- 10 Nm Ø 40 motor
- 13 Nm Ø 40 motor
- 13 Nm Ø 60 motor
- 23 Nm Ø 60 motor





Price list for SK45⁰, Oval *, SKP * roller shutters, woodlike colour, PA43 profile

Net prices in EUR

Box with Ø60 pipe	Box with Ø40 pipe	Width Height	Net prices in EUR																												
			500	600	700	800	900	1000	1100	1200	1300	1400	1500	1600	1700	1800	1900	2000	2100	2200	2300	2400	2500	2600	2700	2800	2900	3000	3100		
137	137	500	87	93	99	105	110	116	123	128	135	141	147	152	159	166	174	181	189	196	204	212	219	226	232	239	245	252	259		
		600	91	97	104	110	116	123	130	136	143	150	155	163	173	183	191	199	207	215	224	232	241	248	257	264	272	280	288		
		700	95	102	109	116	123	131	137	144	151	158	171	180	189	199	207	217	225	234	244	253	262	271	280	290	299	308	318		
		800	101	108	115	123	131	138	146	153	167	177	186	197	206	217	228	237	246	257	268	277	287	297	307	317	327	336	346		
		900	105	113	121	129	137	145	153	167	180	190	200	211	222	233	244	255	265	276	287	298	308	319	330	341	352	362	373		
		1000	111	119	127	136	145	154	169	181	193	205	217	228	240	252	263	275	286	298	310	322	334	346	357	369	380	392	404		
		1100	115	125	133	142	151	167	179	192	205	218	230	242	255	268	280	292	305	317	330	343	354	367	379	391	404	415	428		
165	165	1200	120	130	139	149	165	179	192	205	219	232	246	259	272	286	299	314	327	340	354	366	381	394	408	422	436	450	464		
		1300	125	135	146	162	176	190	204	218	233	248	262	276	290	305	319	334	348	362	377	392	405	420	435	449	463	478	492		
		1400	130	141	152	170	184	200	215	230	245	260	275	290	305	321	336	351	366	381	397	411	427	442	457	473	488	503	519		
		1500	135	147	164	179	195	211	227	243	260	275	292	307	323	340	356	372	387	404	420	436	452	468	483	500	515	531	547		
		1600	141	154	173	190	208	225	242	259	277	294	311	328	346	363	380	397	414	432	450	466	483	501	518	535	553	569	587		
		1700	146	163	181	199	217	234	252	270	289	307	325	343	360	379	397	414	433	451	469	487	505	522	540	558	576	594	611		
		1800	152	171	189	208	227	246	264	284	303	322	340	359	378	398	416	435	453	472	492	511	530	548	567	586	605	623	642		
		1900	157	177	196	217	236	255	275	295	315	334	354	373	393	414	433	452	472	491	511	531	551	571	590	610	629	649	669		
		2000	164	185	205	226	246	267	287	308	329	349	370	391	411	433	452	473	493	514	535	556	576	597	617	638	659	679	700		
		2100	171	192	212	234	255	276	297	319	341	362	383	405	426	448	469	490	511	533	555	578	600	622	645	666	688	710	732	755	
180	180	2200	177	199	221	243	266	287	309	332	355	377	399	421	443	467	489	510	533	555	578	600	622	645	666	688	710	732	755		
		2300	183	206	229	251	274	297	320	343	367	390	412	436	458	482	505	528	551	574	597	621	644	666	690	712	736	758	781		
		2400	189	213	237	261	285	308	332	356	381	405	428	452	476	501	525	548	572	596	621	645	669	693	717	740	764	788	812		
		2500	196	220	245	270	295	319	344	369	395	420	445	469	494	520	544	569	594	619	645	669	694	719	744	769	794	818	844		
		2600	202	228	253	279	304	329	355	380	407	433	458	483	509	536	561	586	612	637	664	691	717	743	770	796	823	849	876		
		2700	209	235	261	287	314	340	367	393	421	447	473	501	527	554	581	608	635	663	690	717	745	771	799	826	854	881	908		
		2800	214	241	269	296	323	350	378	405	433	460	487	515	542	570	598	627	655	684	712	740	769	797	826	854	882	911	939		
205	205	2900	221	249	277	305	333	362	389	418	447	475	503	531	559	588	618	647	676	706	735	764	793	822	851	880	909	939	968		
		3000	228	257	286	315	343	373	401	431	461	489	520	548	577	606	635	665	694	723	752	781	810	840	869	898	927	957			

Winding pipe Ø40 ← → Winding pipe Ø60

Surcharges:	Winding pipe Ø40														Winding pipe Ø60													
Woodlike box RENOLIT	23	28	32	37	42	46	51	56	60	65	69	74	79	83	88	93	97	102	106	111	116	120	125	130	134	139	143	
Woodlike end slat RENOLIT	1	1	1	1	1	2	2	2	2	2	2	2	3	3	3	3	3	3	3	4	4	4	4	4	5	5	5	
Block hangers	2 pieces / 18 €							3 pieces / 27 €							4 pieces / 36 €							5 pieces / 45 €						

Surcharge for guides			
PK53 PPMO PP68	PK53 PP68	PP53	PP53 PVC
woodlike VARNISH (for 1 pcs.)	woodlike RENOLIT (for 1 pcs.)	woodlike RENOLIT (for 2 pcs.)	woodlike RENOLIT (for 2 pcs.)
4	5	2	4
5	6	3	5
6	7	3	6
7	8	3	7
8	9	4	7
9	10	4	8
9	11	5	9
10	12	5	10
11	13	6	11
12	14	6	12
13	15	6	12
14	16	7	13
14	17	7	14
15	18	8	15
16	19	8	16
17	20	9	17
18	21	9	17
19	22	9	18
20	23	10	19
20	24	10	20
21	25	11	21
22	26	11	21
23	27	11	22
24	28	12	23
25	29	12	24
26	30	13	25

Specification
- 10 Nm short Ø 40 motor
- 10 Nm Ø 40 motor
- 13 Nm Ø 40 motor
- 13 Nm Ø 60 motor
- 23 Nm Ø 60 motor

Standard equipment includes:

- a box cut at an angle of 45° in sizes customized to the height of the roller shutter varnished in woodlike colour.
- a winding pipe (shaft) with a diameter of 40 or 60 mm, depending on the dimensions of the roller shutter.
- profile Pa 43 perforated, woodlike colour
- manual control for cord - white box coiler, up to 12 kg.
- 56 mm end slat varnished in woodlike colour with a rubber seal.
- 53 mm woodlike guides, varnished.
- end caps for guide mounting holes.
- steel hangers.
- stopper.
- packing: box with bubble wrap, guides with stretch wrap.

For an extra charge or optional (no information on order form means that the standard will be produce):

- manual control by tape (no surcharge) 0 € pcs.
- box coiler for cord in brown (no surcharge) 0 € pcs.
- anthracite box coiler with gray cord 0 € pcs.
- box coiler for tape in brown or anthracite (no surcharge) 0 € pcs.
- drilling holes in guides (no surcharge) 0 € pcs.
- cable extraction outside the box (no surcharge) 0 € pcs.
- rotating plug instead of buffers (no surcharge) 0 € set
- bottom end cap of the PP53 guides 0 € set
- packing in corrugated cardboard 4 € rm
- packing in a 6 mm thick cardboard 15 € rm
- packing the box and the curtain profile separately 15 € rm
- winder crank for a cord or tape up to 20 kg 30 € set
- automatic lock (only roller shutters without motor) 30 € set
- manual fastening (only roller shutters without motor) 22 € / set
- spring 10 kg Ø 40 + cylinder lock 94 € set
- spring 15 kg Ø 40 + cylinder lock 106 € set
- spring 15 kg Ø 60 + cylinder lock 112 € set
- spring 24 kg Ø 60 + cylinder lock 115 € set
- rolling insect screen 65 € m²
(max 1600mm wide and 2400mm high)
(using a rolling insect screen increases the size of the box)
- drive selected according to legend, drives prices on pages 50 - 57.
- remote control with the appropriate number of channels, prices on pages 50 - 57.
- push-button switch selectable on pages 50 - 57

WARNING! in mahogany, swamp oak, winchester - guides, end slat and box are not available in the varnished version, extra charge for RENOLIT should be added.



Price list for SK45⁰, Oval *, SKP * roller shutters in a non-standard colour, PA43 profile

Net prices in EUR

Box with Ø60 pipe	Box with Ø40 pipe	Width Height	Width																												
			500	600	700	800	900	1000	1100	1200	1300	1400	1500	1600	1700	1800	1900	2000	2100	2200	2300	2400	2500	2600	2700	2800	2900	3000	3100		
137	137	500	111	119	126	134	141	149	157	165	173	180	183	185	203	213	223	232	242	251	261	272	280	289	297	306	314	323	331		
		600	116	125	133	141	149	158	166	174	183	192	199	208	222	234	244	255	265	275	287	297	308	318	328	339	348	359	369		
		700	122	131	139	148	157	167	175	184	194	202	219	230	241	254	265	277	288	300	313	324	335	347	359	371	383	395	407		
		800	129	138	148	158	168	177	187	196	214	226	239	252	264	278	291	303	315	329	343	355	368	380	393	405	418	430	443		
		900	135	145	155	165	176	185	196	214	230	243	257	270	284	298	312	326	340	353	367	381	395	408	422	437	450	464	478		
		1000	142	152	163	174	185	197	217	231	247	262	277	292	307	323	337	352	366	381	397	412	427	442	457	472	487	502	517		
		1100	147	159	171	181	194	213	230	246	262	279	294	310	326	343	358	374	390	406	422	438	454	469	485	501	516	532	548		
150	150	1200	154	166	178	191	211	229	246	263	281	297	315	332	349	366	383	401	418	435	452	469	488	505	523	541	558	576	594		
		1300	160	173	187	207	225	243	261	280	298	317	335	353	371	391	408	427	446	463	483	501	519	538	556	575	593	612	630		
		1400	160	180	194	218	236	256	274	294	314	333	353	372	391	411	430	450	468	488	508	527	546	566	586	605	625	644	664		
		1500	164	188	209	229	250	270	291	311	333	353	373	393	414	435	456	476	496	516	538	558	578	599	619	640	660	680	700		
165	150	1600	171	197	222	244	266	288	310	332	354	376	398	420	442	465	486	508	531	553	576	596	618	640	663	685	707	729	751		
		1700	186	209	232	255	278	300	323	346	369	393	416	438	461	486	508	531	554	577	600	623	646	668	691	714	737	760	782		
		1800	195	219	242	267	291	314	339	363	388	412	436	460	484	509	533	557	581	605	630	654	678	702	726	750	774	798	822		
		1900	201	226	251	278	302	327	352	377	404	428	453	478	503	530	554	579	604	629	655	680	705	730	756	781	806	831	856		
		2000	210	237	263	289	315	342	367	394	421	447	474	500	526	554	579	605	632	658	685	711	737	764	790	816	843	869	896		
180	165	2100	219	246	272	300	326	353	381	408	437	463	491	518	545	573	601	627	654	682	710	737	764	791	818	845	872	899	926		
		2200	226	255	283	311	340	368	396	425	454	482	511	540	567	597	625	653	683	710	740	769	796	825	853	881	909	938	966		
		2300	234	263	293	322	352	381	410	439	469	499	528	557	587	617	647	676	705	735	765	794	824	853	882	912	941	971	1000		
		2400	242	272	304	334	365	395	425	456	488	518	548	579	610	641	672	702	732	763	795	825	856	887	917	948	978	1009	1039		
205	180	2500	250	282	314	345	377	409	440	472	505	537	569	600	632	665	697	729	760	792	825	856	888	920	952	984	1016	1048	1080		
		2600	259	291	324	356	389	421	454	487	521	554	586	619	651	685	718	750	783	816	850	884	918	951	985	1019	1053	1087	1121		
		2700	268	301	334	368	402	436	470	503	539	573	606	640	674	709	744	778	813	848	883	918	953	988	1023	1057	1093	1127	1162		
		2800	274	309	344	379	414	448	483	518	554	589	623	659	693	729	766	802	839	875	911	948	984	1020	1057	1093	1129	1166	1202		
		2900	282	319	355	391	427	463	499	535	573	607	644	680	716	753	791	828	865	903	940	978	1015	1052	1090	1127	1165	1201	1239		
205	205	3000	291	328	366	403	440	477	514	551	590	626	665	701	739	776	813	851	888	925	963	1000	1037	1075	1113	1149	1187	1224			

Winding pipe Ø40 ← → Winding pipe Ø60

Surcharges:	2 pieces / 18 €	3 pieces / 27 €	4 pieces / 36 €	5 pieces / 45 €
Block hangers				

Surcharge for guides	
PK53	4
PPMO	4
PP68	5
non-standard colour (for 1 pcs.)	6
	7
	7
	8
	9
	9
	10
	11
	12
	12
	13
	14
	15
	15
	16
	17
	17
	18
	19
	20
	20
	21
	21
	22

Specification	
- 10 Nm short Ø 40 motor	
- 10 Nm Ø 40 motor	
- 13 Nm Ø 40 motor	
- 13 Nm Ø 60 motor	
- 23 Nm Ø 60 motor	

Standard equipment includes:

- a box cut at an angle of 45° in sizes customized to the height of the roller shutter in the colour of the guides and the end slat, similar to the colour of curtain profile.
- a winding pipe (shaft) with a diameter of 40 or 60 mm, depending on the dimensions of the roller shutter.
- Pa 43 profile, perforated, non-standard colour.
- manual control for cord - box coiler in white.
- 56 mm high end slat with a rubber seal.
- 53 mm guides in the colour of box and end slat, similar to the colour of curtain profile.
- end caps for guide mounting holes.
- steel hangers.
- stopper.
- packing: box with bubble wrap, guides with stretch wrap.

For an extra charge or optional (no information on order form means that the standard will be produce):

- manual control by tape (no surcharge) 0 € pcs.
- box coiler for cord in brown (no surcharge) 0 € pcs.
- anthracite box coiler with gray cord 0 € pcs.
- box coiler for tape in brown or anthracite (no surcharge) 0 € pcs.
- drilling holes in guides (no surcharge) 0 € pcs.
- cable extraction outside the box (no surcharge) 0 € pcs.
- rotating plug instead of buffers (no surcharge) 0 € set
- bottom end cap of the PP53 guides 0 € set
- packing in corrugated cardboard 4 € rm
- packing in a 6 mm thick cardboard 15 € rm
- packing the box and the curtain profile separately 15 € rm
- OWAL* or SKP* box 5% pcs.
- winder crank for a cord or tape up to 20 kg 30 € set
- automatic lock (only roller shutters without motor) 30 € set
- manual fastening (only roller shutters without motor) 22 € / set
- spring 10 kg Ø 40 + cylinder lock 94 € set
- spring 15 kg Ø 40 + cylinder lock 106 € set
- spring 15 kg Ø 60 + cylinder lock 112 € set
- spring 24 kg Ø 60 + cylinder lock 115 € set
- rolling insect screen 65 € m²
(max 1600mm wide and 2400mm high)
(using a rolling insect screen increases the size of the box)
- drive selected according to legend, drives prices on pages 50 - 57.
- remote control with the appropriate number of channels, prices on pages 50 - 57.
- push-button switch selectable on pages 50 - 57

WARNING! colours of end caps and stoppers may significantly differ from other elements colour due to their limited colours.

- aluminum box cut at an angle of 45 degrees "SK 45" or - with extra charge - rounded "Oval" or semi-circular "SKP".
- 66 mm wide aluminum straight guides (by 250 mm box - 75 mm).
- 52 mm aluminum profile filled with polyurethane foam (weight 3 kg / m²).
- maximum dimensions: width 4000 mm, height 3500 mm (for 1 class wind resistance according to EN13659).
- maximum roller shutter surface 8 m².

52 mm „PA-52" aluminum profile.

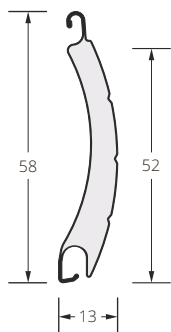

SK45



Oval



SKP

Guides.

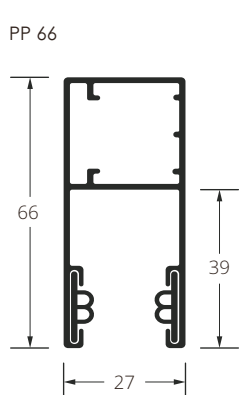

PP 66

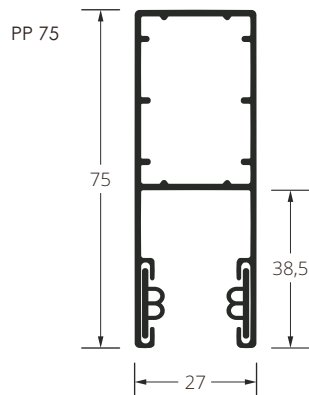

PP 75

Colour	symbol	RAL*	Curtain profile	Box SK45 165 - 205	End slat	Guide PP66	Box SK45 250	Guide PP75	Box OWAL	Box SKP
standard colours	symbol	RAL*								
silver	01	9006	✓	✓	✓	✓	1	1	1	1
white	02	9016	✓	✓	✓	✓	1	1	1	1
grey	03	7038	✓	✓	✓	✓	1	1	1	1
beige	05	1013	✓	✓	✓	✓				
dark brown	08	8019	✓	✓	✓	✓	1	1	1	1
brown	09	8014	✓	✓	✓	✓	1	1	1	1
crème white	15	9001	1	1					1	
ultra white	22		1	1	1			1	1	1
anthracite grey	23	7016	✓	✓	✓	✓	1	1	1	1
light grey	31	7047	1	2	2	2	2	2	2	2

woodlike (surcharge)										
walnut	28		✓	✓						
golden oak	30		✓	✓	✓	✓				
swamp oak	36		✓							
winchester	52		✓							

woodlike, foil, renolite (surcharge)										
golden oak	30R			1		✓				
swamp oak	36R			1						
winchester	52R			1						

non-standard (surcharge)	symbol	RAL*								
green	13	6005	4	2	2	2	2	2	2	2
quartz grey	34	7039	1	✓	1	2	2	2	1	2
grey aluminum	37	9007	4	2	2	2	2	2	2	2
white pearl matt	40		4		1	1			1	
light grey pearl matt	41				1	1		1		
grey pearl matt	42				1	1		1		
anthracite grey pearl matt	43		1		1	1		1		
dark grey pearl matt	44				1	1		1		

* RAL numbers mean the colours similar to real, the most reliable way to verify is our colour sampler.
 1. - longer realization term.
 2. - painting surcharge, longer realization term.
 4. - minimum order is 15 m².



Price list for roller shutters SK45⁰, Oval *, SKP * in woodlike colour, PA52 profile

Net prices in EUR

Box with Ø70 pipe	Box with Ø60 pipe	Width Height	Net prices in EUR																																					
			1300	1400	1500	1600	1700	1800	1900	2000	2100	2200	2300	2400	2500	2600	2700	2800	2900	3000	3100	3200	3300	3400	3500	3600	3700	3800	3900	4000										
250**	165	1000	222	236	250	264	277	293	306	319	334	348	362	376	390	404	418	432	446	460	655	664	672	681	689	697	705	714	722	730	woodlike RENOLIT (for 2 pcs.)									
		1100	237	252	267	282	297	312	327	342	357	371	387	402	417	431	446	460	476	490	707	716	725	734	743	752	761	770	779	788										
		1200	254	270	286	303	318	335	351	367	384	400	415	432	448	465	482	498	515	532	770	781	792	803	814	825	836	847	858	869										
		1300	271	289	306	323	340	358	375	392	410	426	445	461	479	496	514	532	548	566	825	837	849	860	872	884	896	908	919	931										
	180	1400	286	305	323	341	359	378	396	414	432	450	469	487	506	524	543	561	580	598	878	891	904	917	930	943	956	969	982	995										
		1500	304	323	342	361	381	401	420	440	459	478	498	517	537	556	575	594	614	633	934	947	961	974	988	1002	1016	1029	1043	1057										
		1600	323	344	365	386	407	428	449	469	490	511	533	553	574	594	615	636	657	678	1000	1015	1030	1046	1061	1076	1091	1107	1121	1137										
		1700	338	361	382	404	425	448	470	492	513	535	557	579	601	622	644	666	687	709	1051	1067	1083	1099	1115	1131	1147	1163	1179	1196										
	205	1800	356	379	401	424	447	471	494	516	539	562	586	609	632	654	677	700	722	745	1109	1126	1143	1160	1177	1195	1212	1229	1246	1263										
		1900	371	394	418	442	466	491	515	538	562	586	611	634	658	682	706	730	754	778	1163	1181	1200	1217	1236	1254	1273	1291	1309	1327										
		2000	387	413	438	463	487	514	538	563	588	613	638	664	689	714	739	765	789	815	1220	1240	1259	1279	1298	1318	1337	1356	1376	1395										
		2100	403	428	455	480	507	533	559	585	611	637	664	690	716	741	768	793	819	845	1271	1292	1312	1332	1352	1372	1392	1413												
		2200	420	447	473	501	528	556	583	610	637	664	692	720	746	774	801	827	854	881	1329	1350	1372	1393	1414	1436														
		2300	434	463	490	519	546	576	604	632	660	688	717	745	774	802	830	858	886	914	1383	1405	1428	1450																
		2400	451	480	510	539	568	599	628	657	686	716	746	775	804	834	863	892	921	951	1440	1464	1488																	
		2500	469	499	529	559	590	621	651	682	713	743	775	805	835	865	896	927	957	988	1498	1523																		
		2600	484	515	546	578	609	641	673	704	736	767	799	832	864	897	929	961	994	1026																				
		2700	500	533	565	598	631	663	697	729	762	794	826	859	891	923	956	988	1021																					
	250**	2800	515	548	582	615	649	684	717	750	784	819	852	886	920	955	988	1022																						
		2900	532	566	601	636	671	707	741	776	811	846	881	917	952	986	1022																							
		3000	549	584	621	657	692	730	765	802	838	874	911	948	985	1021																								
		3100	566	602	641	677	714	752	789	827	865	903	942	979	1018																									
		3200	583	620	661	697	736	775	813	852	892	932	972	1012	1051																									
		3300	600	637	680	718	757	798	837	878	919	960	1002	1043																										
		3400	617	655	700	738	779	821	861	903	946	989	1032																											
		3500	634	673	720	759	801	843	884	929	973	1018																												

** the box is not available in OVAL or SKP and in colours 28 and 30,
 ** for this box applies 75 mm PP guides (does not appear in woodlike colour).

Winding pipe Ø60 ← | → Winding pipe Ø70

Surcharges:	
Block hangers by Ø 60 shaft	3 pieces / 33 €
Block hangers by Ø 70 shaft	3 pieces / 47 €

Surcharge for guides	
10	
11	
12	
13	
14	
15	
16	
17	
18	
19	
20	
21	
22	
23	
24	
25	
26	
27	
28	
29	
30	
31	
32	
33	
34	
35	

Specification

- 13 Nm Ø 60 motor
- 23 Nm Ø 60 motor
- 13 Nm Ø 70 motor
- 23 Nm Ø 70 motor

- Standard equipment includes:**
- box cut at an angle of 45° in sizes customized to the height of the roller shutter.
 - a winding pipe (shaft) with a diameter of 60 or 70 mm, depending on the dimensions of the roller shutter.
 - Pa 52 profile, perforated, woodlike colour.
 - 60 mm high end slat in woodlike colour with a rubber seal.
 - 66 mm guides in woodlike colour or 75 mm in standard colour (with 250 mm box).
 - end caps for guide mounting holes.
 - steel hangers.
 - packing: box with bubble wrap, guides with stretch wrap.
 - the price does not include the drive, please choose the right one according to legend, drives prices on pages 50 - 57.

- For an extra charge or optional (no information on order form means that the standard will be produce):**
- drilling holes in guides (no surcharge) 0 € pcs.
 - curtain profile without perforation (no surcharge) 0 € pcs.
 - cable extraction outside the box (no surcharge) 0 € m²
 - packing in corrugated cardboard 4 € rm
 - packing in a 6 mm thick cardboard 15 € rm
 - packing the box and the curtain profile separately 15 € rm
 - spring 15 kg Ø 60 + cylinder lock 127 € set
 - spring 24 kg Ø 60 + cylinder lock 130 € set
 - spring 34 kg Ø 60 + cylinder lock 140 € set
 - drive selected according to legend, drives prices on pages 50 - 57.
 - remote control with the appropriate number of channels, prices on pages 50 - 57.
 - push-button switch selectable on pages 50 - 57

WARNING! in mahogany, swamp oak, winchester - boxes 165, 180, 205 are not available in the varnished version, extra charge for RENOLIT should be added.

Net prices in EUR

Box with Ø70 pipe	Box with Ø60 pipe	Width Height	Width																																						
			1300	1400	1500	1600	1700	1800	1900	2000	2100	2200	2300	2400	2500	2600	2700	2800	2900	3000	3100	3200	3300	3400	3500	3600	3700	3800	3900	4000											
250**	165	1000	280	298	315	333	350	369	386	402	421	438	456	474	492	509	527	544	562	579	778	791	802	815	826	838	850	863	874	886	826	838	850	863	874	886					
		1100	299	318	337	355	374	394	412	431	449	468	488	506	526	543	562	580	599	617	838	851	864	876	889	902	915	928	941	954	889	902	915	928	941	954					
		1200	320	341	361	382	401	422	443	462	483	503	524	544	565	586	607	628	649	670	912	927	943	958	973	989	1004	1019	1035	1050	943	958	973	989	1004	1019	1035	1050			
		1300	342	364	385	407	429	451	472	495	516	537	560	582	604	626	648	670	691	713	977	993	1010	1025	1042	1058	1075	1091	1107	1123	1010	1025	1042	1058	1075	1091	1107	1123			
	180	1400	361	384	407	430	453	477	499	522	544	568	591	614	637	660	684	707	731	754	1039	1056	1074	1092	1109	1127	1145	1163	1181	1198	1074	1092	1109	1127	1145	1163	1181	1198			
		1500	383	407	431	455	480	505	529	554	578	602	628	652	676	700	725	749	773	798	1103	1122	1141	1159	1178	1197	1215	1234	1252	1271	1122	1141	1159	1178	1197	1215	1234	1252	1271		
		1600	408	434	460	486	513	540	565	591	618	644	672	697	723	749	776	801	828	854	1181	1202	1223	1244	1264	1285	1305	1326	1346	1368	1202	1223	1244	1264	1285	1305	1326	1346	1368		
		1700	426	454	481	509	536	565	592	619	646	674	702	729	757	784	811	838	866	893	1241	1263	1285	1306	1328	1349	1371	1392	1414	1436	1241	1263	1285	1306	1328	1349	1371	1392	1414	1436	
	205	1800	448	477	506	534	563	593	622	651	680	708	738	767	796	824	853	882	910	939	1308	1332	1355	1378	1401	1424	1447	1470	1493	1517	1308	1332	1355	1378	1401	1424	1447	1470	1493	1517	
		1900	467	497	527	556	587	618	648	678	708	738	770	799	830	859	890	920	950	980	1371	1395	1420	1444	1469	1493	1519	1542	1568	1591	1371	1395	1420	1444	1469	1493	1519	1542	1568	1591	
		2000	488	520	551	583	614	647	678	710	741	773	805	837	868	900	931	963	994	1026	1438	1464	1491	1517	1543	1569	1594	1620	1647	1672	1026	1438	1464	1491	1517	1543	1569	1594	1620	1647	1672
		2100	507	540	573	605	638	672	705	737	770	803	836	869	902	934	967	1000	1032	1064	1498	1525	1551	1578	1606	1632	1659	1686	1064	1498	1525	1551	1578	1606	1632	1659	1686				
		2200	529	563	596	631	665	701	734	769	803	837	872	907	941	975	1009	1043	1076	1111	1565	1594	1622	1650	1678	1707	1076	1111	1565	1594	1622	1650	1678	1707							
		2300	547	583	618	653	689	726	761	796	831	867	904	939	975	1010	1046	1081	1117	1152	1627	1657	1687	1717	1117	1152	1627	1657	1687	1717											
		2400	569	605	642	679	716	755	792	828	865	902	940	977	1013	1051	1087	1124	1161	1198	1695	1726	1758	1124	1161	1198	1695	1726	1758												
		2500	590	629	667	705	743	783	821	859	898	936	976	1014	1052	1090	1129	1168	1206	1244	1762	1796	1129	1168	1206	1244	1762	1796													
	250**	2600	609	649	688	728	767	808	847	887	927	966	1007	1048	1089	1130	1171	1211	1252	1293	1171	1211	1252	1293																	
		2700	630	671	712	753	794	836	878	919	960	1000	1041	1082	1123	1163	1204	1245	1286	1204	1245	1286																			
		2800	649	691	733	776	818	862	903	946	988	1031	1074	1117	1159	1202	1245	1288	1245	1288																					
		2900	671	714	758	801	845	890	934	978	1022	1066	1110	1155	1199	1243	1288	1288																							
		3000	691	736	783	827	872	919	964	1010	1057	1102	1148	1195	1241	1287																									
		3100	713	758	807	853	900	948	994	1042	1090	1138	1186	1234	1282																										
		3200	734	781	832	879	927	977	1024	1074	1124	1174	1224	1274	1325																										
		3300	756	803	857	905	954	1005	1054	1107	1158	1210	1262	1314																											
		3400	777	825	882	930	981	1034	1084	1138	1192	1246	1300																												
		3500	799	848	907	956	1009	1062	1114	1171	1227	1282																													

** the box is not available in OVAL or SKP and in colours 28 and 30, for this box applies 75 mm PP guides.

Winding pipe Ø60 ← → Winding pipe Ø70

Surcharges:	
Block hangers by Ø 60 shaft	3 pieces / 33 €
Block hangers by Ø 70 shaft	3 pieces / 47 €

Specification

- 13 Nm Ø 60 motor
- 23 Nm Ø 60 motor
- 13 Nm Ø 70 motor
- 23 Nm Ø 70 motor

Standard equipment includes:

- box cut at an angle of 45° in sizes customized to the height of roller shutter in non-standard colour.
- a winding pipe (shaft) with a diameter of 60 or 70 mm, depending on the dimensions of the roller shutter.
- Pa 52 profile, perforated, non-standard colour.
- 60 mm high end slat in non-standard colour with a rubber seal.
- 66 or 75 mm guides (depending on the dimensions of the roller shutter), in non-standard colour.
- end caps for guide mounting holes.
- steel hangers.
- packing: box with bubble wrap, guides with stretch wrap.
- the price does not include the drive, please choose the right one according to legend, drives prices on pages 50 - 57.

For an extra charge or optional (no information on order form means that the standard will be produce):

- drilling holes in guides (no surcharge) 0 € pcs.
- curtain profile without perforation (no surcharge) 0 € pcs.
- cable extraction outside the box (no surcharge) 0 € m²
- OWAL* or SKP* box (only standard colour) 5% pcs.
- packing in corrugated cardboard 4 € rm
- packing in a 6 mm thick cardboard 15 € rm
- packing the box and the curtain profile separately 15 € rm
- spring 15 kg Ø 60 + cylinder lock 127 € set
- spring 24 kg Ø 60 + cylinder lock 130 € set
- spring 34 kg Ø 60 + cylinder lock 140 € set
- drive selected according to legend, drives prices on pages 50 - 57.
- remote control with the appropriate number of channels, prices on pages 50 - 57.
- push-button switch selectable on pages 50 - 57

WARNING! colours of end caps and stoppers may significantly differ from other elements colour due to their limited colours.

- rectangular unvarnished aluminum box
- 53 mm wide aluminum straight guides or - with extra charge - PK53, PPMO.
- 39 mm aluminum profile filled with polyurethane foam (weight 2,8 kg/m²).
- maximum dimensions: width 3200 mm, height 3500 mm (for 1 class wind resistance according to EN13659).
- manual drive in the form of a box coiler for cord or tape (maximum curtain profile weight: up to 12 kg).
- maximum roller shutter surface 6 m².

39 mm „PA-39“ aluminum profile.

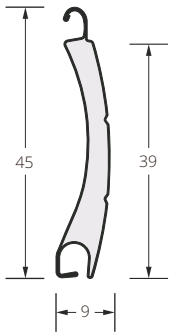

SP-E

„PP-53“ guide.

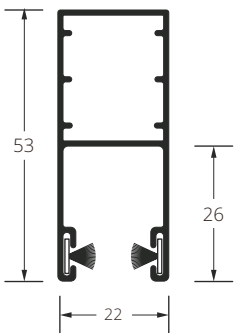

* RAL numbers mean the colours similar to real, the most reliable way to verify is our colour sampler.

1. – longer realization term.
2. – painting surcharge, longer realization term.
3. – in the size 205 mm the box is not available.
4. – minimum order is 15 m².

Colour	symbol	RAL*	Curtain profile	Revision flap	End slat	Guide PP53	Guide PK53	Guide PPMO	Distance D/PP	Guide PP68	
silver	01	9006	✓	✓	✓	✓	✓	✓	✓	✓	standard colours
white	02	9016	✓	✓	✓	✓	✓	✓	✓	✓	
grey	03	7038	✓	✓	✓	✓	✓	2	✓	✓	
dark beige	04	1019	✓								
beige	05	1013	✓		✓	✓	✓		✓	✓	
dark brown	08	8019	✓	✓	✓	✓	✓	✓	✓	✓	
brown	09	8014	✓	✓	✓	✓	✓	2	✓	✓	
crème white	15	9001	✓		✓	✓	1				
ivory	16	1015	✓	2	2	2	2	2	2	2	
ultra white	22		1	1	✓	✓	2		1	1	
anthracite grey	23	7016	✓	✓	✓	✓	✓	✓	✓	✓	
light grey	31	7047	✓	2	2	2	2	2	2	2	
dark wood	06		1								woodlike (surcharge)
light wood	07		1								
mahogany	26		✓								
walnut	28		✓		✓	✓	✓	✓		✓	
golden oak	30		✓		✓	✓	✓	✓		✓	
swamp oak	36		✓								
winchester	52		✓								
light oak	79		✓								
dark wood	23R			1	1	1	1				woodlike foil renolite (surcharge)
mahogany	26R				✓	✓	✓		✓		
walnut	28R			✓	✓	✓	✓		✓	✓	
golden oak	30R			✓	✓	✓	✓		✓	✓	
swamp oak	36R			✓	✓	✓	✓				
winchester	52R			✓	✓	✓	✓				
light oak	79R			3	1	1					
alux db PVC	46F					1					PF53 PVC woodlike veneer RENOLIT (extra charge)
brushed aluminium PVC	47F					1					
light silver PVC	48F					1					
sheffield oak light PVC	49F					1					
sheffield oak alpine PVC	50F					1					
sheffield oak concreto PVC	51F					1					
turner oak PVC	52F					1					
jet black matt PVC	53F					1					
red	12	3003	4	2	2	2	2	2	2	2	non-standard (surcharge)
green	13	6005	4	2	2	2	2	2	2	2	
fir green	17	6009	4	2	2	2	2	2	2	2	
steel blue	18	5011	4	2	2	2	2	2	2	2	
burgundy	19	3005	4	2	2	2	2	2	2	2	
black	20	9005	1	2	1	2	2	2	2	2	
basalt grey	33	7012	✓	2	2	2	2	2	2	2	
quartz grey	34	7039	✓	2	✓	✓	2	2	2	2	
concrete grey	35	7023	4	2	2	2	2	2	2	2	
grey aluminium	37	9007	1	2	2	2	2	2	2	2	
white pearl matt	40		4	2	1	1	2		2		
light grey pearl matt	41			2	2	1	2		2		
grey pearl matt	42			2	2	1	2		2		
anthracite grey pearl matt	43		1	2	1	1	2		2		
dark grey pearl matt	44			2	2	1	2		2		

Price list for SP-E roller shutters in the standard colour, PA39 profile

Net prices in EUR

Box with Ø60 pipe	Box with Ø40 pipe	Width Height	Net prices in EUR																															
			500	600	700	800	900	1000	1100	1200	1300	1400	1500	1600	1700	1800	1900	2000	2100	2200	2300	2400	2500	2600	2700	2800	2900	3000	3100	3200				
137	137	500	81	86	90	95	100	105	111	115	120	126	130	135	141	148	155	160	167	173	181	188	194	200	206	212	218	225	231	237				
		600	83	88	94	99	104	110	115	120	126	131	137	142	152	160	167	173	181	188	196	203	210	217	224	231	238	245	252	259				
		700	86	92	98	103	108	114	119	125	131	137	148	156	163	172	179	187	195	203	211	218	226	234	242	250	257	265	273	281				
		800	90	95	101	108	114	120	126	132	144	152	161	169	178	187	195	204	212	220	230	238	246	254	262	270	279	287	295	303				
		900	92	99	105	112	118	124	131	143	153	162	171	180	189	199	208	217	226	235	245	254	262	272	281	289	298	307	316	325				
		1000	97	103	110	116	123	130	144	154	164	174	184	194	203	214	223	233	243	253	263	273	282	292	302	311	321	331	340	350				
		1100	99	106	114	120	127	142	152	162	173	184	194	205	215	226	236	246	257	267	278	289	299	309	320	330	341	351	362	372				
		1200	103	111	118	125	140	151	162	172	185	195	207	218	229	241	252	262	274	285	297	308	319	330	340	351	362	373	384	395				
150	150	1300	107	115	122	136	147	159	171	183	195	207	219	231	243	255	267	279	291	303	315	327	339	350	362	374	385	397	409	420				
		1400	109	118	126	142	154	167	179	191	205	217	230	242	255	268	280	293	305	314	330	344	355	367	379	391	403	415	427	439				
		1500	111	121	136	150	163	176	189	202	216	229	242	255	268	282	296	309	322	335	349	362	375	388	401	415	428	441	454	467				
		1600	114	130	147	162	176	190	205	218	234	247	262	276	291	306	320	334	348	362	377	392	405	420	435	449	463	478	492	506				
165	150	1700	123	138	153	168	182	198	212	227	243	257	272	287	302	318	333	347	362	377	393	407	423	438	452	468	483	498	513	528				
		1800	129	144	160	175	190	207	222	237	254	270	285	301	316	333	348	364	379	395	411	427	442	458	473	489	504	519	535	551				
		1900	133	150	165	181	198	214	230	246	262	279	296	311	328	345	361	377	393	409	426	443	459	475	491	507	524	540	556					
		2000	139	155	171	189	206	222	240	256	275	291	308	325	341	359	376	393	411	427	445	462	479	495	513	530	546	564						
180	165	2100	143	160	178	195	212	230	247	265	283	301	318	336	353	372	389	407	424	442	460	477	495	514	532	550								
		2200	148	166	184	203	220	239	257	275	294	312	331	349	367	387	404	423	441	459	479	497	515	533	551									
		2300	152	171	190	209	227	246	265	284	304	322	341	360	379	399	417	436	455	474	494	512	532	551										
		2400	158	177	196	215	235	255	274	294	314	334	354	373	393	413	433	452	472	492	512	532	551											
205	180	2500	168	189	210	231	252	272	293	313	336	356	377	398	419	440	461	482	503	524	545	566												
		2600	173	195	216	238	260	281	302	324	347	368	390	411	433	455	477	498	520	542	564													
		2700	178	199	222	244	266	288	310	333	356	378	400	423	444	468	490	512	534	556														
		2800	182	206	229	252	274	297	320	344	367	390	413	435	459	482	505	528	551															
205	205	2900	187	210	234	258	281	305	328	352	376	400	423	447	470	495	518	542																
		3000	191	215	240	264	288	312	336	360	385	409	433	459	482	507	531	555																

Winding pipe Ø40 ← → Winding pipe Ø60

Surcharges:																																
Revision flap in woodlike colour RENOLIT	5	6	7	8	9	10	11	12	13	14	15	16	17	18	19	20	21	22	23	24	25	26	27	28	29	30	31	32				
Woodlike end slat	4	5	5	6	7	8	8	9	10	11	11	12	13	14	14	15	16	17	17	18	19	20	20	20	21	22	23	23	24			
Woodlike end slat RENOLIT	4	5	6	7	8	9	9	10	11	12	13	14	14	15	16	17	18	19	20	20	21	22	23	24	25	26	26	27				
Block hangers	2 pieces / 18 €								3 pieces / 27 €								4 pieces / 36 €								5 pieces / 45 €							

Standard equipment includes:

- rectangular unvarnished aluminum box.
- revision flap in standard colour.
- a winding pipe (shaft) with a diameter of 40 or 60 mm, depending on the dimensions of the roller shutter.
- Pa 39 profile, perforated, standard colour.
- manual control for cord - white box coiler, up to 12 kg.
- 56 mm high end slat with a rubber seal.
- 53 mm guides, standard colour.
- end caps for guide mounting holes.
- steel hangers.
- stopper.
- cable extraction outside in electric roller shutter on the side of the box.
- packing of box and guides with stretch wrap.

For an extra charge or optional (no information on order form means that the standard will be produce):

- manual control by tape (no surcharge) 0 € pcs.
- box coiler for cord in brown (no surcharge) 0 € pcs.
- anthracite box coiler with gray cord 0 € pcs.
- box coiler for tape in brown or anthracite (no surcharge) 0 € pcs.
- drilling holes in guides (no surcharge) 0 € pcs.
- rotating plug instead of buffers (no surcharge) 0 € set
- curtain profile without perforation (no surcharge) 0 € pcs.
- bottom end cap of the PP53 guides 0 € set
- packing in corrugated cardboard 4 € rm
- packing in a 6 mm thick cardboard 15 € rm
- packing the box and the curtain profile separately 15 € rm
- winder crank for cord or tape up to 20 kg 30 € set
- revision flap varnishing 30 € pcs.
- the guides varnishing 25 € set
- the end slat varnishing 15 € pcs.
- surcharge to curtain profile - woodlike colour 5 € m²
- surcharge to curtain profile - non-standard colour 8 € m²
- automatic lock (only roller shutters without motor) 30 € set
- manual fastening (only roller shutters without motor) 22 € / set
- spring 10 kg Ø 40 + cylinder lock 94 € set
- spring 15 kg Ø 40 + cylinder lock 106 € set
- spring 15 kg Ø 60 + cylinder lock 112 € set
- spring 24 kg Ø 60 + cylinder lock 115 € set
- insulation the box from the inside with 3 mm thick Onduterm XL insulation mat (additional thermal conductivity (0,56 (m²K)/W) 6 € rm
- rolling insect screen (max 1600mm wide and 2400mm high) (using a rolling insect screen increases the size of the box) 65€ m²
- drive selected according to legend, drives prices on pages 50 - 57.
- remote control with the appropriate number of channels, prices on pages 50 - 57.
- push-button switch selectable on pages 50 - 57

Surcharge for guides					
PP53 (2 pcs.)	PP53 (2 pcs.)	PP53 PVC (2 pcs.)	PK53 PPMO PP68 (1 pcs.)	PK53 PPMO PP68 (1 pcs.)	PK53 PP68 (1 pcs.)
woodlike VARNISH	woodlike RENOLIT	woodlike RENOLIT	standard colour	woodlike VARNISH	woodlike RENOLIT
2	4	6	3	9	12
3	5	8	3	9	13
3	6	9	4	10	13
3	7	10	4	10	14
4	8	11	5	11	14
4	9	13	6	11	15
5	9	14	6	12	15
5	10	15	7	12	16
6	11	16	7	13	16
6	12	18	8	13	17
6	13	19	8	14	18
7	14	20	9	15	18
7	14	21	9	15	19
8	15	23	10	16	19
8	16	24	10	16	20
9	17	25	11	17	20
9	18	26	12	17	21
9	19	28	12	18	21
10	20	29	13	18	22
10	20	30	13	19	22
11	21	31	14	20	23
11	22	33	14	20	24
11	23	34	15	21	24
12	24	35	15	21	25
12	25	36	16	22	25
13	26	38	17	22	26

Specification

- 10 Nm short Ø 40 motor
- 10 Nm Ø 40 motor
- 13 Nm Ø 40 motor
- 13 Nm Ø 60 motor
- 23 Nm Ø 60 motor

Price list for roller shutters SP-E in woodlike colour, PA39 profile

Net prices in EUR

Box with Ø60 pipe	Box with Ø40 pipe	Width Height	Width																															
			500	600	700	800	900	1000	1100	1200	1300	1400	1500	1600	1700	1800	1900	2000	2100	2200	2300	2400	2500	2600	2700	2800	2900	3000	3100	3200				
137	137	500	85	90	95	101	106	112	118	123	129	134	140	145	151	159	166	173	179	187	194	202	209	215	222	229	236	243	250	257				
		600	88	94	100	105	111	117	123	129	135	141	147	153	163	172	179	187	195	203	210	218	226	234	242	249	257	265	272	280				
		700	92	98	104	110	116	122	128	134	142	148	160	167	176	185	193	202	210	218	227	235	243	252	260	269	278	286	294	303				
		800	96	103	109	116	122	129	136	142	155	164	173	182	191	201	210	218	228	236	246	255	265	274	283	293	302	311	320	330				
		900	100	106	114	120	127	134	141	155	165	175	184	194	204	214	223	233	242	252	262	272	282	292	301	310	320	330	340	349				
		1000	103	111	119	126	134	141	156	166	177	187	198	208	218	230	240	250	261	271	282	293	303	313	324	334	345	355	365	376				
		1100	107	115	123	131	138	153	164	175	187	198	209	219	231	243	254	265	275	287	298	309	320	332	343	354	365	376	388	399				
150	150	1200	112	120	128	136	151	163	175	186	199	210	222	234	246	259	270	282	294	306	318	330	341	353	364	376	388	400	411	423				
		1300	116	124	133	147	160	172	185	198	211	223	236	249	261	274	287	299	312	324	338	350	363	375	387	400	412	424	437	449				
		1400	118	129	138	154	167	181	194	207	221	234	247	260	273	288	301	313	327	340	354	367	380	394	407	421	435	448	462	475				
		1500	121	133	149	163	177	190	205	218	233	246	261	274	288	304	317	331	345	359	374	387	401	415	429	443	457	471	485	499				
		1600	124	142	160	176	190	205	220	235	251	266	281	297	311	327	341	357	372	387	403	417	433	448	463	478	494	508	524	539				
165	165	1700	136	151	167	182	198	214	229	245	261	276	293	308	323	340	356	371	387	402	419	435	450	466	481	496	512	527	543	558				
		1800	141	158	173	190	207	223	240	256	273	289	306	322	338	356	372	388	405	421	439	455	471	488	504	520	536	553	569	585				
		1900	146	163	180	197	214	231	248	265	283	300	317	334	351	369	386	403	420	437	454	472	489	506	523	540	557	574	591					
180	165	2000	151	169	188	205	223	241	259	276	295	312	330	348	366	385	402	420	438	455	475	492	510	528	545	563	581	599						
		2100	158	176	194	212	231	249	267	286	305	323	341	360	378	398	416	435	453	471	491	508	527	546	565	583								
		2200	164	182	201	220	240	259	278	297	317	336	355	375	394	413	433	451	471	490	510	529	548	567	586									
		2300	168	188	207	227	247	266	286	306	327	346	366	386	405	427	447	466	486	506	526	545	566	586										
205	180	2400	173	194	215	235	256	276	297	318	339	359	380	400	421	443	463	484	504	524	545	566	587											
		2500	186	207	229	251	272	294	316	338	360	383	404	426	448	470	492	514	535	557	580	602												
		2600	191	214	236	259	281	304	326	349	372	395	417	440	463	486	508	531	554	576	600													
		2700	197	219	242	266	289	312	335	359	383	405	429	452	475	499	523	545	569	591														
205	205	2800	202	226	250	273	298	322	346	369	395	418	442	466	490	515	539	563	586															
		2900	207	231	256	280	305	330	354	379	404	429	453	478	503	528	553	577																
		3000	211	237	262	287	312	337	363	389	414	439	464	490	515	542	566	591																

Winding pipe Ø40 ← → Winding pipe Ø60

Surcharges:																																	
Revision flap in woodlike colour RENOLIT		5	6	7	8	9	10	11	12	13	14	15	16	17	18	19	20	21	22	23	24	25	26	27	28	29	30	31	32				
Woodlike end slat RENOLIT		1	1	1	1	1	2	2	2	2	2	2	2	3	3	3	3	3	3	3	3	4	4	4	4	4	5	5	5				
Block hangers		2 pieces / 18 €						3 pieces / 27 €						4 pieces / 36 €						5 pieces / 45 €													

Surcharge for guides			
PK53 PPMO PP68	PK53 PP68	PP53	PP53 PVC
woodlike VARNISH	woodlike RENOLIT	woodlike RENOLIT	woodlike RENOLIT
(for 1 pcs.)	(for 1 pcs.)	(for 2 pcs.)	(for 2 pcs.)
4	5	2	4
5	6	3	5
6	7	3	6
7	8	3	7
8	9	4	7
9	10	4	8
9	11	5	9
10	12	5	10
11	13	6	11
12	14	6	12
13	15	6	12
14	16	7	13
14	17	7	14
15	18	8	15
16	19	8	16
17	20	9	17
18	21	9	17
19	22	9	18
20	23	10	19
20	24	10	20
21	25	11	21
22	26	11	21
23	27	11	22
24	28	12	23
25	29	12	24
26	30	13	25

Specification	- 10 Nm short Ø 40 motor	

Standard equipment includes:

- rectangular unvarnished aluminum box.
- revision flap in **standard colour**.
- a winding pipe (shaft) with a diameter of 40 or 60 mm, depending on the dimensions of the roller shutter.
- profile Pa 39 perforated, woodlike colour.
- manual control for cord - white box coiler, up to 12 kg.
- 56 mm end slat varnished in woodlike colour with a rubber seal.
- 53 mm woodlike guides, varnished.
- end caps for guide mounting holes.
- steel hangers.
- stopper.
- cable extraction outside in electric roller shutter on the side of the box.
- packing of box and guides with stretch wrap.

For an extra charge or optional (no information on order form means that the standard will be produce):

- manual control by tape (no surcharge) 0 € pcs.
- box coiler for cord in brown (no surcharge) 0 € pcs.
- anthracite box coiler with gray cord 0 € pcs.
- box coiler for tape in brown or anthracite (no surcharge) 0 € pcs.
- drilling holes in guides (no surcharge) 0 € pcs.
- rotating plug instead of buffers (no surcharge) 0 € set
- curtain profile without perforation (no surcharge) 0 € pcs.
- bottom end cap of the PP53 guides 0 € set
- packing in corrugated cardboard 4 € rm
- packing in a 6 mm thick cardboard 15 € rm
- packing the box and the curtain profile separately 15 € rm
- winder crank for cord or tape up to 20 kg 30 € set
- revision flap varnishing 30 € pcs.
- automatic lock (only roller shutters without motor) 30 € set
- manual fastening (only roller shutters without motor) 22 € / set
- spring 10 kg Ø 40 + cylinder lock 94 € set
- spring 15 kg Ø 40 + cylinder lock 106 € set
- spring 15 kg Ø 60 + cylinder lock 112 € set
- spring 24 kg Ø 60 + cylinder lock 115 € set
- insulation the box from the inside with 3 mm thick Onduterm XL insulation mat (additional thermal conductivity (0,56 (m²K)/W) 6 € rm
- rolling insect screen (max 1600mm wide and 2400mm high) 65 € m²
- (using a rolling insect screen increases the size of the box)
- drive selected according to legend, drives prices on pages 50 - 57.
- remote control with the appropriate number of channels, prices on pages 50 - 57.
- push-button switch selectable on pages 50 - 57

WARNING! in mahogany, swamp oak, winchester - guides, end slat and revision flap are not available in the varnished version, extra charge for RENOLIT should be added.

Price list for SP-E roller shutters in non-standard colour, PA39 profile

Net prices in EUR

Box with Ø60 pipe	Box with Ø40 pipe	Width Height	Width																											
			500	600	700	800	900	1000	1100	1200	1300	1400	1500	1600	1700	1800	1900	2000	2100	2200	2300	2400	2500	2600	2700	2800	2900	3000	3100	3200
137	137	500	110	118	124	131	138	145	153	160	168	175	182	188	196	207	216	224	233	243	253	262	271	280	289	298	307	316	325	334
		600	115	122	130	137	145	152	160	167	176	184	191	199	212	223	233	244	253	263	273	284	294	304	314	324	334	344	354	364
		700	119	127	135	143	151	159	167	175	184	192	208	218	229	240	251	262	272	283	295	305	316	328	339	350	361	371	383	394
		800	124	133	142	150	159	168	176	184	202	213	224	237	248	261	272	284	296	307	320	332	344	356	368	380	392	404	416	429
		900	130	138	147	156	166	174	184	201	215	227	239	252	265	278	291	303	315	328	341	353	366	379	391	404	416	429	441	454
		1000	134	145	155	164	174	183	202	216	231	244	257	270	284	299	312	325	339	353	367	380	394	407	421	435	448	462	475	489
		1100	139	150	160	170	180	199	213	228	244	257	271	285	300	315	330	344	358	373	388	402	416	431	446	460	475	489	504	518
150	150	1200	145	156	167	177	197	212	227	242	258	273	289	304	319	337	352	367	382	397	414	429	443	459	474	489	504	519	534	549
		1300	150	162	173	192	208	224	240	257	274	291	306	323	339	357	373	389	405	422	439	455	471	487	503	520	536	552	568	584
		1400	156	167	179	201	218	235	252	269	287	304	321	339	355	374	391	407	425	441	460	477	494	512	530	547	565	583	600	618
		1500	154	173	193	211	230	247	266	284	303	320	339	357	375	395	413	430	448	467	486	503	522	540	558	576	594	612	631	648
165	150	1600	162	185	209	229	248	267	286	306	326	346	366	386	404	425	444	464	484	503	524	543	563	583	602	622	641	661	681	700
		1700	176	197	217	237	257	278	298	318	340	359	380	400	420	442	462	483	503	523	544	565	585	605	625	645	666	685	706	726
		1800	184	205	225	248	269	290	312	332	354	376	398	419	440	462	484	505	526	548	570	591	613	634	655	676	697	718	739	760
		1900	190	212	234	257	279	301	323	345	368	390	413	434	456	480	501	524	546	568	591	613	635	657	680	701	724	746	768	
		2000	197	220	244	267	290	313	337	359	383	406	430	452	476	500	523	546	570	591	617	639	663	686	709	732	755	778		
180	165	2100	205	229	252	276	300	324	348	371	396	420	444	468	492	517	541	565	589	612	637	661	685	709	734	758				
		2200	213	237	261	286	312	337	361	386	412	437	462	487	512	538	562	587	612	637	663	688	713	737	762					
		2300	218	244	269	296	321	347	372	399	425	450	476	502	527	554	580	606	632	657	684	709	735	761						
		2400	225	253	279	306	332	359	386	413	441	467	494	521	547	575	602	629	655	682	709	736	764							
		2500	241	269	298	326	354	382	410	439	469	497	525	553	582	611	639	668	695	725	754	783								
205	180	2600	248	278	306	337	366	395	424	453	484	514	542	572	601	632	661	691	720	749	780									
		2700	256	285	315	346	375	406	436	466	497	527	557	588	618	649	680	709	739	769										
		2800	263	294	325	355	387	418	449	480	513	544	575	606	637	670	700	732	762											
		2900	268	301	333	364	396	429	461	493	525	557	589	622	654	686	718	750												
205	205	3000	274	307	341	373	406	439	472	505	538	571	604	637	670	704	736	768												

Surcharge for guides	
PK53 PPMO PP68	non-standard colour (for 1 pcs.)
4	
4	
5	
6	
7	
7	
8	
9	
9	
10	
11	
12	
12	
13	
14	
15	
15	
16	
17	
17	
18	
19	
20	
20	
21	
22	

Surcharges:	Winding pipe Ø40		Winding pipe Ø60	
Block hangers	2 pieces / 18 €		3 pieces / 27 €	
			4 pieces / 36 €	
			5 pieces / 45 €	

Specification	
- 10 Nm short Ø 40 motor	
- 10 Nm Ø 40 motor	
- 13 Nm Ø 40 motor	
- 13 Nm Ø 60 motor	
- 23 Nm Ø 60 motor	

Standard equipment includes:

- rectangular unvarnished aluminum box.
- revision flap in non-standard colour.
- a winding pipe (shaft) with a diameter of 40 or 60 mm, depending on the dimensions of the roller shutter.
- Pa 39 profile, perforated, non-standard colour.
- manual control for cord - white box coiler, up to 12 kg.
- 56 mm end slat in non-standard colour with a rubber seal.
- 53 mm guides in non-standard colour.
- end caps for guide mounting holes.
- steel hangers.
- stopper.
- cable extraction outside in electric roller shutter on the side of the box.
- packing of box and guides with stretch wrap.

For an extra charge or optional (no information on order form means that the standard will be produce):

- manual control by tape (no surcharge) 0 € pcs.
- box coiler for cord in brown (no surcharge) 0 € pcs.
- anthracite box coiler with gray cord 0 € pcs.
- box coiler for tape in brown or anthracite (no surcharge) 0 € pcs.
- drilling holes in guides (no surcharge) 0 € pcs.
- rotating plug instead of buffers (no surcharge) 0 € set
- curtain profile without perforation (no surcharge) 0 € pcs.
- bottom end cap of the PP53 guides 0 € set
- packing in corrugated cardboard 4 € rm
- packing in a 6 mm thick cardboard 15 € rm
- packing the box and the curtain profile separately 15 € rm
- winder crank for cord or tape up to 20 kg 30 € set
- revision flap varnishing 30 € pcs.
- automatic lock (only roller shutters without motor) 30 € set

- manual fastening (only roller shutters without motor) 22 € / set
- spring 10 kg Ø 40 + cylinder lock 94 € set
- spring 15 kg Ø 40 + cylinder lock 106 € set
- spring 15 kg Ø 60 + cylinder lock 112 € set
- spring 24 kg Ø 60 + cylinder lock 115 € set
- insulation the box from the inside with 3 mm thick Onduterm XL
- insulation mat (additional thermal conductivity (0,56 (m²K)/W) 6 € rm
- rolling insect screen 68 € m²
- (max 1600mm wide and 2400mm high)
- (using a rolling insect screen increases the size of the box)
- drive selected according to legend, drives prices on pages 50 - 57.
- remote control with the appropriate number of channels, prices on pages 50 - 57.
- push-button switch selectable on pages 50 - 57

WARNING! colours of end caps and stoppers may significantly differ from other elements colour due to their limited colours.



Price list for SP-E roller shutters in woodlike colour, PA43 profile

Net prices in EUR

Box with Ø60 pipe	Box with Ø40 pipe	Width Height	Width																												
			500	600	700	800	900	1000	1100	1200	1300	1400	1500	1600	1700	1800	1900	2000	2100	2200	2300	2400	2500	2600	2700	2800	2900	3000	3100		
137	137	500	88	94	100	106	112	118	125	131	138	144	150	156	162	171	179	186	194	202	210	218	225	233	241	248	256	264	271		
		600	92	99	106	112	118	125	132	139	146	152	159	166	177	187	195	204	212	220	229	238	246	255	263	272	281	289	298		
		700	96	104	111	118	124	131	139	146	154	161	174	182	192	202	211	220	229	238	249	257	267	276	286	296	305	314	324		
		800	101	109	116	124	132	140	148	155	169	179	189	199	210	220	230	241	251	260	271	281	292	302	312	323	334	345	356	367	377
		900	106	114	122	130	138	146	155	169	181	191	203	213	224	236	247	258	268	279	290	301	312	323	334	345	356	367	377		
		1000	110	119	128	137	146	154	170	182	195	206	218	230	242	254	265	277	289	301	313	325	337	349	360	372	384	396	407		
150	150	1100	115	124	134	143	152	168	181	194	207	218	231	243	256	269	282	294	306	319	332	345	357	370	383	396	408	421	434		
		1200	120	130	140	150	166	179	193	206	219	233	247	260	273	288	301	314	328	341	355	369	382	395	408	421	435	448	461		
		1300	124	135	146	161	176	190	204	218	234	248	262	277	291	306	320	334	349	363	378	392	406	421	435	449	463	477	491		
		1400	128	140	151	169	185	199	214	229	245	261	275	291	306	321	337	351	367	381	397	412	428	443	459	474	490	505	520		
		1500	132	145	163	179	195	210	226	243	259	275	291	307	322	340	356	372	387	404	420	436	452	468	484	499	516	532	547		
		1600	135	156	175	193	210	227	244	261	279	297	313	331	348	366	383	400	417	435	452	470	487	504	522	539	556	573	591		
165	165	1700	148	165	183	201	218	237	254	272	291	309	327	345	363	381	400	417	435	452	471	490	507	525	543	561	579	597	614		
		1800	153	172	190	210	229	247	266	285	304	323	342	361	380	400	419	437	456	475	495	513	532	551	570	588	607	626	644		
		1900	159	178	198	218	238	257	276	297	316	336	356	375	395	415	435	454	474	494	514	534	553	573	592	611	631	650	670		
		2000	165	186	207	227	247	268	289	308	330	350	371	392	412	434	454	474	495	515	537	557	578	598	618	639	660	680	700		
		2100	171	193	214	235	256	278	299	320	342	363	384	405	426	449	470	491	513	534	556	577	598	619	641	663	684	705	727		
		2200	179	200	222	244	266	289	310	332	356	377	400	422	444	467	489	511	534	555	579	601	623	645	666	688	710	732	753		
180	180	2300	183	207	229	253	274	298	320	344	367	390	413	436	459	483	505	528	551	574	598	620	644	666	689	712	735	758	781		
		2400	190	214	237	261	285	308	332	357	381	405	429	452	476	500	525	549	572	595	620	644	668	693	717	741	766	790	815		
		2500	203	227	253	278	303	328	353	378	404	430	454	480	505	531	556	582	606	632	658	683	709	734	760	785	811	836	862		
		2600	209	235	260	287	313	339	365	391	418	444	470	496	523	549	575	601	627	654	681	708	736	763	791	818	845	873	900		
		2700	215	241	268	295	321	349	375	403	430	457	483	510	537	565	593	622	650	678	706	734	763	791	819	847	875	903	931		
		2800	221	249	276	304	332	360	387	415	444	471	499	527	554	583	611	640	669	697	726	754	783	811	840	868	897	926	954		
205	205	2900	226	255	284	311	340	369	397	426	455	483	512	541	569	599	629	658	688	717	747	777	807	836	866	895	925	955	985		
		3000	231	261	291	319	349	378	408	438	467	496	526	555	584	613	642	671	700	729	758	787	816	844	873	902	931	960			

Winding pipe Ø40 ← → Winding pipe Ø60

Surcharges:																															
Revision flap in woodlike colour RENOLIT	5	6	7	8	9	10	11	12	13	14	15	16	17	18	19	20	21	22	23	24	25	26	27	28	29	30	31				
Woodlike end slat RENOLIT	1	1	1	1	1	2	2	2	2	2	2	2	3	3	3	3	3	3	3	4	4	4	4	4	4	5	5				
Block hangers	2 pieces / 18 €							3 pieces / 27 €							4 pieces / 36 €							5 pieces / 45 €									

Surcharge for guides			
PK53 PPMO PP68	PK53 PP68	PP53	PP53 PVC
woodlike VARNISH (for 1 pcs.)	woodlike RENOLIT (for 1 pcs.)	woodlike RENOLIT (for 2 pcs.)	woodlike RENOLIT (for 2 pcs.)
4	5	2	4
5	6	3	5
6	7	3	6
7	8	3	7
8	9	4	7
9	10	4	8
9	11	5	9
10	12	5	10
11	13	6	11
12	14	6	12
13	15	6	12
14	16	7	13
14	17	7	14
15	18	8	15
16	19	8	16
17	20	9	17
18	21	9	17
19	22	9	18
20	23	10	19
20	24	10	20
21	25	11	21
22	26	11	21
23	27	11	22
24	28	12	23
25	29	12	24
26	30	13	25

- 10 Nm short Ø 40 motor	
- 10 Nm Ø 40 motor	
- 13 Nm Ø 40 motor	
- 13 Nm Ø 60 motor	
- 23 Nm Ø 60 motor	

Standard equipment includes:

- rectangular unvarnished aluminum box.
- revision flap in standard colour.
- a winding pipe (shaft) with a diameter of 40 or 60 mm, depending on the dimensions of the roller shutter.
- profile Pa 43 perforated, woodlike colour.
- manual control for cord - white box coiler, up to 12 kg.
- 56 mm end slat varnished in woodlike colour with a rubber seal.
- 53 mm woodlike guides, varnished.
- end caps for guide mounting holes.
- steel hangers.
- stopper.
- cable extraction outside in electric roller shutter on the side of the box.
- packing of box and guides with stretch wrap.

For an extra charge or optional (no information on order form means that the standard will be produce):

- manual control by tape (no surcharge) 0 € pcs.
- box coiler for cord in brown (no surcharge) 0 € pcs.
- anthracite box coiler with gray cord 0 € pcs.
- box coiler for tape in brown or anthracite (no surcharge) 0 € pcs.
- drilling holes in guides (no surcharge) 0 € pcs.
- rotating plug instead of buffers (no surcharge) 0 € set
- curtain profile without perforation (no surcharge) 0 € pcs.
- bottom end cap of the PP53 guides 0 € set
- packing in corrugated cardboard 4 € rm
- packing in a 6 mm thick cardboard 15 € rm
- packing the box and the curtain profile separately 15 € rm
- winder crank for cord or tape up to 20 kg 30 € set
- revision flap varnishing 30 € pcs.
- automatic lock (only roller shutters without motor) 30 € set
- manual fastening (only roller shutters without motor) 22 € / set
- spring 10 kg Ø 40 + cylinder lock 94 € set
- spring 15 kg Ø 40 + cylinder lock 106 € set
- spring 15 kg Ø 60 + cylinder lock 112 € set
- spring 24 kg Ø 60 + cylinder lock 115 € set
- insulation the box from the inside with 3 mm thick Onduterm XL insulation mat (additional thermal conductivity (0,56 (m²k)/W)) 6 € rm
- rolling insect screen (max 1600mm wide and 2400mm high) (using a rolling insect screen increases the size of the box) 65 € m²
- drive selected according to legend, drives prices on pages 50 - 57.
- remote control with the appropriate number of channels, prices on pages 50 - 57.
- push-button switch selectable on pages 50 - 57

WARNING! in mahogany, swamp oak, winchester - guides, end slat and revision flap are not available in the varnished version, extra charge for RENOLIT should be added

Price list for SP-E roller shutters in non-standard colour, PA43 profile

Net prices in EUR

Box with Ø60 pipe	Box with Ø40 pipe	Width Height	Width																														
			500	600	700	800	900	1000	1100	1200	1300	1400	1500	1600	1700	1800	1900	2000	2100	2200	2300	2400	2500	2600	2700	2800	2900	3000	3100				
137	137	500	113	121	128	135	143	152	160	168	177	184	192	199	208	219	229	239	248	258	268	279	289	299	308	318	327	338	347				
		600	118	127	135	143	152	160	169	177	187	195	204	212	227	239	250	261	271	282	293	304	315	326	337	348	359	370	381				
		700	123	133	142	151	160	168	178	187	197	206	223	233	246	258	270	282	294	305	318	329	342	353	366	378	390	402	414				
		800	129	140	149	159	169	179	190	199	216	229	242	255	268	282	295	308	321	333	347	360	374	387	400	413	426	440	453				
		900	135	145	156	166	177	187	198	217	232	245	259	273	287	302	316	330	343	357	371	386	400	413	427	442	455	469	483				
		1000	141	153	164	176	187	197	218	233	250	264	279	294	309	325	340	355	370	385	401	416	431	446	461	477	492	507	522				
150	150	1100	147	159	171	183	194	215	231	248	264	280	296	311	327	345	361	377	393	409	425	442	458	474	491	506	522	539	555				
		1200	154	166	179	191	212	229	247	263	281	298	316	333	350	369	386	402	420	437	455	472	489	505	522	540	556	574	590				
		1300	159	173	187	206	225	243	261	280	299	317	336	354	372	392	410	428	446	465	484	502	520	539	556	575	593	611	629				
		1400	164	179	193	217	236	255	275	294	314	334	352	372	391	411	431	449	469	488	508	528	547	567	587	607	627	646	666				
		1500	168	186	209	229	250	269	290	311	332	352	373	393	413	435	456	476	495	517	538	558	578	599	620	639	660	681	701				
165	165	1600	173	199	225	247	269	290	312	334	357	380	401	423	445	468	490	512	534	556	579	601	624	646	668	689	712	734	756				
		1700	189	212	234	257	279	303	325	348	373	395	419	441	464	488	511	534	557	579	603	627	649	672	695	718	741	764	786				
		1800	196	220	244	269	293	317	341	365	389	414	438	462	486	512	536	560	584	608	633	657	682	705	729	753	777	801	825				
		1900	203	228	253	279	304	328	353	380	405	430	456	480	505	532	556	581	607	632	657	683	708	733	758	783	808	833	858				
		2000	211	238	264	290	317	343	369	395	423	448	475	501	527	555	581	607	634	659	687	713	740	766	791	818	844	870	896				
		2100	219	247	274	301	328	355	382	410	437	465	492	519	545	575	602	629	656	683	712	738	766	793	821	848	875	903	930				
180	180	2200	229	256	284	312	341	369	398	425	455	483	512	541	569	598	626	654	683	711	741	769	797	825	853	881	909	937	965				
		2300	235	264	293	323	352	381	410	440	470	499	528	557	587	618	647	676	706	734	765	794	824	853	882	912	941	970	1000				
		2400	243	274	304	334	365	395	425	457	488	518	549	579	610	641	672	702	732	762	794	824	855	887	918	949	980	1012	1043				
		2500	259	291	324	355	387	420	452	484	518	550	582	614	647	680	712	744	776	809	842	875	907	940	973	1006	1038	1071	1104				
		2600	267	301	333	367	400	434	467	501	535	569	601	635	669	703	736	770	803	837	872	907	942	977	1012	1047	1082	1117	1153				
205	205	2700	275	309	343	378	411	446	480	515	550	585	619	653	687	724	760	796	832	868	904	940	976	1012	1048	1084	1120	1156	1192				
		2800	283	318	353	389	424	460	495	531	568	603	638	674	710	746	783	819	856	892	929	965	1002	1038	1075	1111	1148	1185	1221				
		2900	289	326	363	399	436	472	508	545	583	619	656	692	729	767	804	842	880	918	957	994	1032	1070	1108	1146	1184	1222	1260				
		3000	296	334	372	408	446	484	522	560	597	635	673	711	748	784	822	859	896	933	970	1007	1044	1081	1118	1155	1192	1229					

Winding pipe Ø40 ← → Winding pipe Ø60

Surcharges:	
Block hangers	2 pieces / 18 €
	3 pieces / 27 €
	4 pieces / 36 €
	5 pieces / 45 €

Surcharge for guides	
PK53 PPMO PP68 non-standard colour (for 1 pcs.)	
4	
4	
5	
6	
7	
7	
8	
9	
9	
10	
11	
12	
12	
13	
14	
15	
15	
16	
17	
17	
18	
19	
20	
20	
21	
22	

Specification	
- 10 Nm short Ø 40 motor	
- 10 Nm Ø 40 motor	
- 13 Nm Ø 40 motor	
- 13 Nm Ø 60 motor	
- 23 Nm Ø 60 motor	

Standard equipment includes:

- rectangular unvarnished aluminum box.
- revision flap in non-standard colour.
- a winding pipe (shaft) with a diameter of 40 or 60 mm, depending on the dimensions of the roller shutter.
- Pa 43 profile, perforated, non-standard colour.
- manual control for cord - white box coiler, up to 12 kg.
- 56 mm high end slat in non-standard colour with a rubber seal.
- 53 mm guides, non-standard colour.
- end caps for guide mounting holes.
- steel hangers.
- stopper.
- cable extraction outside in electric roller shutter on the side of the box.
- packing of box and guides with stretch wrap.

For an extra charge or optional (no information on order form means that the standard will be produce):

- manual control by tape (no surcharge) 0 € pcs.
- box coiler for cord in brown (no surcharge) 0 € pcs.
- anthracite box coiler with gray cord 0 € pcs.
- box coiler for tape in brown or anthracite (no surcharge) 0 € pcs.
- drilling holes in guides (no surcharge) 0 € pcs.
- rotating plug instead of buffers (no surcharge) 0 € set
- curtain profile without perforation (no surcharge) 0 € pcs.
- bottom end cap of the PP53 guides 0 € set
- packing in corrugated cardboard 4 € rm
- packing in a 6 mm thick cardboard 15 € rm
- packing the box and the curtain profile separately 15 € rm
- winder crank for cord or tape up to 20 kg 30 € set
- revision flap varnishing 30 € pcs.
- automatic lock (only roller shutters without motor) 30 € set
- manual fastening (only roller shutters without motor) 22 € / set
- spring 10 kg Ø 40 + cylinder lock 94 € set
- spring 15 kg Ø 40 + cylinder lock 106 € set
- spring 15 kg Ø 60 + cylinder lock 112 € set
- spring 24 kg Ø 60 + cylinder lock 115 € set
- insulation the box from the inside with 3 mm thick Onduterm XL
- insulation mat (additional thermal conductivity (0,56 (m²K)/W) 6 € rm
- rolling insect screen (max 1600mm wide and 2400mm high) 65 € m² (using a rolling insect screen increases the size of the box)
- drive selected according to legend, drives prices on pages 50 - 57.
- remote control with the appropriate number of channels, prices on pages 50 - 57.
- push-button switch selectable on pages 50 - 57

WARNING! colours of end caps and stoppers may significantly differ from other elements colour due to their limited colours.

- rectangular unvarnished aluminum box.
- 66 mm wide aluminum straight guides.
- 52 mm aluminum profile filled with polyurethane foam (weight 3 kg / m²).
- maximum dimensions: width 3400 mm, height 2500 mm (for 1 class wind resistance according to EN13659).
- maximum roller shutter surface 8 m².

52 mm „PA-52“ aluminum profile.

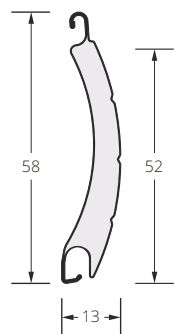

„PP-66“ guide.

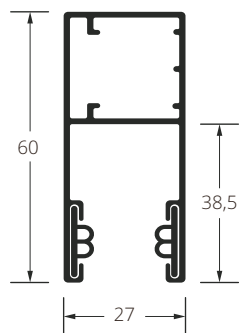

SP-E

Colour	symbol	RAL*	Curtain profile	Revision flap	End slat	Guide PP66
standard colours	symbol	RAL*				
srebrny	01	9006	✓	✓	✓	✓
biały	02	9016	✓	✓	✓	✓
szary	03	7038	✓	✓	✓	✓
beżowy	05	1013	✓		✓	✓
ciemnobrązowy	08	8019	✓	✓	✓	✓
brązowy	09	8014	✓	✓	✓	✓
biel kremowa	15	9001	1			
ultra biały	22		1	1	1	
szary antracyt	23	7016	✓	✓	✓	✓
jasny szary	31	7047	1	2	2	2

woodlike (surcharge)						
orzech	28		✓			
złoty dąb	30		✓		✓	✓
dąb bagienny	36		✓			
winchester	52		✓			

woodlike, foil, renolite (surcharge)						
antracyt	23R			1		
orzech	28R			✓		
złoty dąb	30R			✓		1
dąb bagienny	36R			✓		
winchester	52R			✓		

non-standard (surcharge)	symbol	RAL*	1	2	2	1
zielony	13	6005	1	2	2	
kwarcowy szary	34	7039	1	2	1	
szare aluminium	37	9007	1	2	2	1
biały perłowy mat	40		4	2	1	1
jasny szary perłowy mat	41			2	1	1
szary perłowy mat	42			2	1	1
szary antracyt perłowy mat	43		1	2	1	1
ciemny szary perłowy mat	44			2	1	1

* RAL numbers mean the colours similar to real, the most reliable way to verify is our colour sampler.

1. – longer realization term.

2. – painting surcharge, longer realization term.

4. – minimum order is 15 m².

Price list for SP-E roller shutters in standard colour, PA52 profile

Box with Ø60 pipe	Width Height	Net prices in EUR																							
		1300	1400	1500	1600	1700	1800	1900	2000	2100	2200	2300	2400	2500	2600	2700	2800	2900	3000	3100	3200	3300	3400		
165	1000	211	224	238	251	264	278	292	306	318	332	346	359	373	386	399	412	425	439	634	642	649	657		
	1100	225	239	254	268	282	297	311	326	340	354	369	384	398	412	427	441	456	470	686	695	704	713		
	1200	241	256	272	287	302	318	334	349	364	380	397	412	427	442	457	472	488	503	739	749	758			
	1300	256	273	289	306	322	340	358	373	389	405	423	440	456	472	488	505	521	538	795	806				
180	1400	270	288	306	322	340	358	376	393	410	425	447	464	481	498	515	532	550	566	845	857				
	1500	286	305	323	341	360	379	399	416	435	454	473	492	510	529	547	566	585	603	903					
	1600	308	328	348	368	388	409	429	449	469	489	510	530	550	570	590	610	630	650	971					
	1700	322	343	364	385	405	428	449	469	490	511	534	554	575	597	618	639	660	682						
205	1800	338	360	383	404	426	449	471	494	515	538	560	582	604	626	648	670	692	714						
	1900	352	375	398	421	444	468	491	514	537	559	583	607	630	653	676	699	722	745						
	2000	369	392	416	440	464	489	513	537	562	585	610	634	658	683	707	731	755							
	2100	382	407	432	456	482	507	532	558	583	608	634	658	684	710	735	761	787							
	2200	397	423	450	476	502	529	555	581	607	633	661	686	713	739	765	791								
	2300	411	438	465	492	520	547	575	602	629	656	684	711	738	766	794	821								
205	2400	425	453	481	509	538	566	594	623	650	680	707	735	764	793	824									
	2500	439	468	496	526	556	584	614	644	672	702	730	759	790	820	853									

Surcharge for guides	
woodlike VARNISH (for 2 pcs.)	woodlike RENOLIT (for 2 pcs.)
7	17
8	19
9	21
9	22
10	24
11	26
12	28
12	29
13	31
14	33
15	35
15	36
16	38
17	40
17	41
18	43

Surcharges:	
Revision flap in woodlike colour RENOLIT	13 14 15 16 17 18 19 20 21 22 23 24 25 26 27 28 29 30 31 32 33 34
Woodlike end slat RENOLIT	11 12 12 13 14 15 16 17 17 18 19 20 21 21 22 23 24 25 26 26 27 28
Block hangers	3 pieces / 33 € 4 pieces / 44 € 5 pieces / 55 € 6 pieces / 66 €

Specification
- 13 Nm Ø 60 motor

Standard equipment includes:

- rectangular unvarnished aluminum box.
- revision flap in standard colour.
- a winding pipe (shaft) with a diameter of 60 mm.
- Pa 52 profile, perforated, standard colour.
- 60 mm high end slat with a rubber seal.
- 66 mm guides, standard colour.
- end caps for guide mounting holes.
- steel hangers.
- cable extraction outside in electric roller shutter on the side of the box.
- packing of box and guides with stretch wrap.
- the price does not include the drive, please choose the right one according to legend, drives prices on pages 50 - 57.

For an extra charge or optional (no information on order form means that the standard will be produce):

- drilling holes in guides (no surcharge) 0 € pcs.
- curtain profile without perforation (no surcharge) 0 € pcs.
- packing in corrugated cardboard 4 € rm
- packing in a 6 mm thick cardboard 15 € rm
- packing the box and the curtain profile separately 15 € rm
- revision flap varnishing 30 € pcs.
- the guides varnishing 25 € set
- the end slat varnishing 15 € pcs.
- surcharge to curtain profile - woodlike colour 10 € m²
- surcharge to curtain profile - non-standard colour 20 € m²
- spring 15 kg Ø 60 + cylinder lock 127€ set
- spring 24 kg Ø 60 + cylinder lock 130 € set
- spring 34 kg Ø 60 + cylinder lock 140 € set
- insulation the box from the inside with 3 mm thick Onduterm XL insulation mat (additional thermal conductivity (0,56 (m²K)/W) 6 € rm
- drive selected according to legend, drives prices on pages 50 - 57.
- remote control with the appropriate number of channels, prices on pages 50 - 57.
- push-button switch selectable on pages 50 - 57

Price list for SP-E roller shutters in woodlike colour, PA52 profile

Net prices in EUR

Box with Ø60 pipe	Width Height	Net prices in EUR																							
		1300	1400	1500	1600	1700	1800	1900	2000	2100	2200	2300	2400	2500	2600	2700	2800	2900	3000	3100	3200	3300	3400		
165	1000	224	237	252	266	280	294	308	322	336	350	365	379	393	407	421	435	449	463	659	668	676	684		
	1100	239	254	268	283	298	313	329	344	359	374	389	404	420	435	450	464	480	495	712	722	732	741		
	1200	255	271	287	304	319	337	353	368	384	400	417	433	449	465	481	497	513	529	767	777	787			
	1300	272	289	306	323	340	359	376	393	410	427	445	462	479	496	514	531	547	565	824	835				
180	1400	286	305	322	341	359	378	396	414	433	450	470	488	506	525	543	562	581	599	879	892				
	1500	303	322	341	361	380	400	420	439	458	478	498	517	536	555	575	594	614	633	933					
	1600	326	347	368	388	409	431	451	472	492	514	535	556	577	598	619	640	660	681	1003					
	1700	341	362	384	405	428	450	472	494	515	537	559	581	603	624	646	668	689	711						
205	1800	357	380	403	426	449	472	495	518	542	564	588	610	633	656	679	701	724	747						
	1900	372	396	420	443	467	492	516	539	563	588	611	636	660	683	707	731	755	779						
	2000	388	413	439	463	488	515	539	564	589	614	640	665	689	715	740	765	789							
	2100	403	429	455	481	507	534	560	586	611	637	665	690	716	742	769	795	821							
	2200	420	447	474	501	528	556	583	610	637	665	693	720	746	773	800	827								
	2300	435	462	491	518	546	576	603	631	660	688	717	744	773	801	829	858								
	2400	449	477	507	536	565	595	623	653	682	711	740	769	799	828	859									
	2500	463	492	524	553	583	615	644	675	704	734	764	793	825	856	888									

Surcharge for guides
woodlike RENOLIT (for 2 pcs.)
10
11
12
13
14
15
16
17
18
19
20
21
22
23
24
25

Surcharges:

Revision flap in woodlike colour RENOLIT	13	14	15	16	17	18	19	20	21	22	23	24	25	26	27	28	29	30	31	32	33	34		
Block hangers	3 pieces / 33 €						4 pieces / 44 €						5 pieces / 55 €						6 pieces / 66 €					

Specification
- 13 Nm Ø 60 motor

Standard equipment includes:

- rectangular unvarnished aluminum box.
- revision flap in **standard colour**.
- a winding pipe (shaft) with a diameter of 60 mm.
- Pa 52 profile, perforated, woodlike colour..
- 60 mm high end slat varnished in woodlike colour with a rubber seal.
- 66 mm woodlike guides, varnished.
- end caps for guide mounting holes.
- steel hangers.
- cable extraction outside in electric roller shutter on the side of the box.
- packing of box and guides with stretch wrap.
- the price does not include the drive, please choose the right one according to legend, drives prices on pages 50 - 57.

For an extra charge or optional (no information on order form means that the standard will be produce):

- drilling holes in guides (no surcharge) 0 € pcs.
- curtain profile without perforation (no surcharge) 0 € pcs.
- packing in corrugated cardboard 4 € rm
- packing in a 6 mm thick cardboard 15 € rm
- packing the box and the curtain profile separately 15 € rm
- revision flap varnishing 30 € pcs.
- spring 15 kg Ø 60 + cylinder lock 127€ set
- spring 24 kg Ø 60 + cylinder lock 130 € set
- spring 34 kg Ø 60 + cylinder lock 140 € set
- insulation the box from the inside with 3 mm thick Onduterm XL insulation mat (additional thermal conductivity (0,56 (m²K)/W) 6 € rm
- drive selected according to legend, drives prices on pages 50 - 57.
- remote control with the appropriate number of channels, prices on pages 50 - 57.
- push-button switch selectable on pages 50 - 57

Price list for SP-E roller shutters in non-standard colour, PA52 profile

Net prices in EUR

Box with Ø60 pipe	Width Height	1300	1400	1500	1600	1700	1800	1900	2000	2100	2200	2300	2400	2500	2600	2700	2800	2900	3000	3100	3200	3300	3400
		165	1000	282	299	318	335	353	371	389	406	424	442	460	477	495	513	531	548	566	584	783	795
1100	301		319	338	357	375	395	415	434	452	471	490	509	529	547	567	585	605	624	845	858	872	885
1200	321		341	362	382	402	424	444	464	484	505	526	546	566	586	606	626	647	666	908	922	937	
1300	342		364	386	407	429	452	473	495	517	538	561	583	604	625	647	669	690	712	975	991		
180	1400	360	384	406	429	452	476	499	522	545	568	591	614	638	662	685	709	732	755	1040	1058		
	1500	381	405	430	455	478	505	529	553	578	602	628	651	676	700	725	749	773	797	1103			
	1600	410	437	463	489	516	542	568	595	620	647	674	700	727	753	779	806	832	858	1185			
	1700	429	456	484	511	539	568	594	622	649	676	705	732	760	786	814	841	868	896				
205	1800	450	478	508	537	566	595	624	653	682	710	740	770	798	826	855	884	912	941				
	1900	469	498	529	558	589	620	650	680	710	740	771	801	831	861	891	921	951	981				
	2000	489	521	552	584	615	648	679	710	743	773	806	838	869	901	932	964	995					
	2100	508	541	573	606	638	673	705	738	771	803	837	870	902	936	968	1002	1034					
	2200	529	563	597	631	665	700	734	768	803	837	873	907	940	974	1008	1042						
	2300	547	582	618	653	688	726	760	795	831	867	903	937	973	1009	1045	1081						
	2400	566	601	639	675	712	750	785	823	859	896	933	968	1007	1044	1082							
	2500	584	620	660	697	735	776	811	850	887	925	963	999	1040	1079	1119							

Surcharges:	
Block hangers	3 pieces / 33 € 4 pieces / 44 € 5 pieces / 55 € 6 pieces / 66 €

Specification
- 13 Nm Ø 60 motor

Standard equipment includes:

- rectangular unvarnished aluminum box.
- revision flap in non-standard colour.
- a winding pipe (shaft) with a diameter of 60 mm.
- Pa52 perforated profile in non-standard colour.
- 60 mm high end slat in non-standard colour with a rubber seal.
- 66 mm guides, non-standard colour.
- end caps for guide mounting holes.
- steel hangers.
- cable extraction outside in electric roller shutter on the side of the box.
- packing of box and guides with stretch wrap.
- the price does not include the drive, please choose the right one according to legend, drives prices on pages 50 - 57.

For an extra charge or optional (no information on order form means that the standard will be produce):

- drilling holes in guides (no surcharge) 0 € pcs.
- curtain profile without perforation (no surcharge) 0 € pcs.
- packing in corrugated cardboard 4 € rm
- packing in a 6 mm thick cardboard 15 € rm
- packing the box and the curtain profile separately 15 € rm
- revision flap varnishing 30 € pcs.
- surcharge to curtain profile - woodlike colour 10 € m²
- surcharge to curtain profile - non-standard colour 20 € m²
- spring 15 kg Ø 60 + cylinder lock 127€ set
- spring 24 kg Ø 60 + cylinder lock 130 € set
- spring 34 kg Ø 60 + cylinder lock 140 € set
- insulation the box from the inside with 3 mm thick Onduterm XL insulation mat (additional thermal conductivity (0,56 (m²K)/W) 6 € rm
- drive selected according to legend, drives prices on pages 50 - 57.
- remote control with the appropriate number of channels, prices on pages 50 - 57.
- push-button switch selectable on pages 50 - 57



BECLEVER on a 39 mm aluminum profile

- PVC box, insulated.
- 60 mm wide PVC guides or ALU for an extra charge.
- 39 mm aluminum profile filled with polyurethane foam (weight 2,8 kg/m³).
- maximum dimensions: width 2700 mm, height 4000 mm (for 1 class wind resistance according to EN13659).
- manual drive in the form of a box coiler for tape (maximum curtain profile weight: up to 12 kg).
- maximum roller shutter surface 6 m².



BECLEVER

39 mm „PA-39“ aluminum profile.

“PG-02” guide.

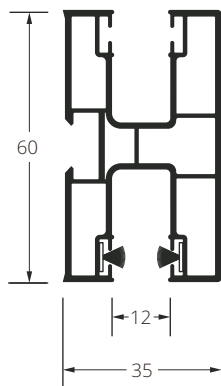
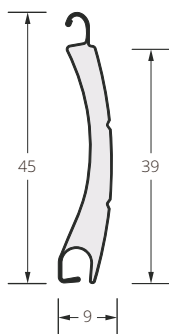

* RAL numbers mean the colours similar to real, the most reliable way to verify is our colour sampler.

- 1. – longer realization term.
- 2. – painting surcharge, longer realization term.
- 4. – minimum order is 15 m².

Colour	symbol	RAL*	Curtain profile	End slat	PVC Guide	Box	Revision flap	ALU Guide	Guide distance	Box BeClever OWAL	Cover plate for box (from the outside)	
silver	01	9006	✓	✓				2	2		2	standard colours
white	02	9016	✓	✓	✓	✓	✓	2	2	✓	2	
grey	03	7038	✓	✓				2	2		2	
dark beige	04	1019	✓									
beige	05	1013	✓	✓								
dark brown	08	8019	✓	✓				2	2		2	
brown	09	8014	✓	✓				2	2		2	
crème white	15	9001	✓	1				2	2		2	
ivory	16	1015	✓	2								
ultra white	22		1	1								
anthracite grey	23	7016	✓	✓				2	2		2	
light grey	31	7047	✓	1				2	2		2	
dark wood	06		1									woodlike (surcharge)
light wood	07		1									
mahogany	26		✓									
walnut	28		✓	✓								
golden oak	30		✓	✓								
swamp oak	36		✓									
winchester	52		✓									
light oak	79		1									
grey	03R	715505			✓	1	1			1		woodlike foil renolite (surcharge)
anthracite	23R	701605		1	✓	1	✓			1		
anthracite smooth	23RG	701605-083		1	✓	1	1			1		
mahogany	26R	2065021		✓	✓	1	1			1		
walnut	28R	2178007		✓	✓	1	✓		✓	1		
golden oak	30R	2178001		✓	✓	1	✓		✓	1		
basalt grey	33R	701205			1	1	1			1		
basalt grey smooth	33RG	701205-083			1	1	1			1		
quartz grey	34R	701205			1	1	1			1		
swamp oak	36R	2052089		✓	✓	1	✓			1		
winchester	52R	49240		✓	✓	1	✓			1		
palisander	54R	851805			1	1	1			1		
chocolate brown	55R	887505			1	1	1			1		
crème white	66R	137905			1	1	1			1		
light oak	79R			1								
alux db PVC	46F				✓							
brushed aluminium PVC	47F				✓							
light silver PVC	48F				✓							
sheffield oak light PVC	49F				✓							
sheffield oak alpine PVC	50F				✓							
sheffield oak concreto PVC	51F				✓							
turner oak PVC	52F				✓							
jet black matt PVC	53F				✓							
red	12	3003	4	2				2	2		2	non-standard (surcharge)
green	13	6005	4	2				2	2		2	
fir green	17	6009	4	2				2	2		2	
steel blue	18	5011	4	2				2	2		2	
burgundy	19	3005	4	2				2	2		2	
black	20	9005	4	2				2	2		2	
basalt grey	33	7012	✓	2				2	2		2	
quartz grey	34	7039	✓	✓				2	2		2	
concrete grey	35	7023	4	2				2	2		2	
grey aluminum	37	9007	1	2				2	2		2	
white pearl matt	40		4	2								
light grey pearl matt	41			2								
grey pearl matt	42			2								
anthracite grey pearl matt	43		1	1								
dark grey pearl matt	44			2								



Price list for BECLEVER roller shutters in standard colour, profile PA39

		Net prices in EUR																										
Box with Ø60 pipe	Box with Ø40 pipe	Width Height	500	600	700	800	900	1000	1100	1200	1300	1400	1500	1600	1700	1800	1900	2000	2100	2200	2300	2400	2500	2600	2700	Surcharge for guides		
																										non-standard or woodlike colour (for 2 pcs.)	aluminum varnished in RAL colour (for 2 pcs.)	distance varnished in RAL colour
160	160	500	87	90	93	100	106	113	118	124	131	136	137	151	165	173	181	190	199	206	215	223	231	248	255	5	16	11
		600	89	93	98	104	111	117	124	130	137	144	150	167	179	187	196	205	215	223	232	241	250	258	267	6	19	13
		700	92	97	102	109	115	123	129	137	144	151	163	183	192	202	211	221	230	241	250	259	281	283	292	8	22	15
		800	94	100	105	112	119	127	134	141	154	163	173	192	203	214	224	233	243	254	264	275	284	293	296	9	25	18
		900	98	103	109	116	124	132	140	153	164	174	185	205	216	227	238	249	260	271	282	293	304	315	326	10	28	20
		1000	100	106	112	120	128	136	151	162	172	183	194	216	227	239	250	262	273	284	296	308	319	331	342	11	31	22
		1100	104	110	116	125	133	149	161	172	183	195	207	228	241	254	265	278	290	303	315	327	339	351	363	12	34	24
		1200	107	113	120	129	144	157	169	182	193	206	218	241	255	267	280	293	306	319	332	345	358	372	385	13	38	26
		1300	109	116	124	138	151	164	177	189	202	216	228	251	265	279	292	306	320	333	347	360	373	386	399	14	41	29
		1400	114	120	128	145	158	171	186	199	212	226	240	264	278	293	307	321	336	350	365	378	393	407	422	15	44	31
1500	116	123	136	150	164	179	193	207	221	236	250	275	290	304	319	334	349	364	379	393	408	423	437	16	47	33		
1600	118	125	143	157	172	187	202	217	232	247	263	287	303	319	335	350	365	381	397	412	428	444	460	17	50	35		
1700	120	132	147	163	179	194	209	225	241	256	272	298	314	330	347	363	379	395	411	427	444	460	476	18	53	37		
1800	121	137	153	169	186	202	218	235	251	267	283	311	328	344	361	378	395	412	429	446	463	480	497	19	56	40		
200	200	1900	125	142	159	175	192	209	226	243	259	276	294	321	338	356	373	391	408	426	443	460	478	495	512	20	59	42
		2000	135	149	164	182	200	217	235	252	270	288	305	333	352	370	388	406	425	443	461	480	497	515	534	22	63	44
		2100	138	152	171	189	207	226	244	263	281	299	318	346	365	384	404	423	441	460	480	498	517	536	555	23	66	46
		2200	142	157	176	194	214	233	252	271	289	308	328	356	376	395	415	434	454	473	493	513	533	552	572	24	69	48
		2300	146	162	182	202	221	241	260	280	299	319	339	369	389	410	430	450	471	491	512	532	552	572	25	72	51	
		2400	149	167	187	207	227	248	268	288	308	329	348	379	400	421	442	463	484	505	526	547	568	26	75	53		
		2500	151	172	192	215	235	256	277	297	319	340	360	392	413	435	457	479	500	522	544	564	27	78	55			
		2600	154	174	196	217	239	260	281	303	324	346	368	399	422	444	467	488	511	533	555	28	81	57				
		2700	158	179	201	223	246	268	291	313	335	357	379	412	435	458	481	504	527	550	29	84	59					
		2800	161	184	207	230	254	276	299	322	345	368	392	425	448	472	496	520	543	30	88	62						
240	240	2900	165	189	212	236	259	283	307	330	354	377	401	435	459	485	508	532	31	91	64							
		3000	168	192	217	241	265	290	315	338	362	386	411	445	470	499	520	544	32	94	66							
Surcharges:			Winding pipe Ø40													Winding pipe Ø60												
Non-standard revision flap			5	6	7	8	9	10	11	12	13	14	15	16	17	18	19	20	21	22	23	24	25	26	27			
Non-standard outer part			7	8	9	10	12	13	14	16	17	18	20	21	22	23	25	26	27	29	30	31	33	34	35			
Non-standard internal part			7	8	9	10	12	13	14	16	17	18	20	21	22	23	25	26	27	29	30	31	33	34	35			
Woodlike end slat			4	5	5	6	7	8	8	9	10	11	11	12	13	14	14	15	16	17	17	18	19	20	20			
Woodlike end slat RENOLIT			4	5	6	7	8	9	9	10	11	12	13	14	15	16	17	18	19	20	20	21	22	23				
Cover plate for ALU box from the outside			28	33	39	44	50	55	61	66	72	77	83	88	94	99	105	110	116	121	127	132	138	143	149			
Steel strengthening the front and bottom profile			4	5	6	7	8	9	10	11	11	12	13	14	15	16	17	18	18	19	20	21	22	23	24			
Block hangers			2 pieces / 18 €					3 pieces / 27 €					4 pieces / 36 €					5 pieces / 45 €										

Surcharge for guides		
non-standard or woodlike colour (for 2 pcs.)	aluminum varnished in RAL colour (for 2 pcs.)	distance varnished in RAL colour
5	16	11
6	19	13
8	22	15
9	25	18
10	28	20
11	31	22
12	34	24
13	38	26
14	41	29
15	44	31
16	47	33
17	50	35
18	53	37
19	56	40
20	59	42
22	63	44
23	66	46
24	69	48
25	72	51
26	75	53
27	78	55
28	81	57
29	84	59
30	88	62
31	91	64
32	94	66

Specification

- 10 Nm short Ø 40 motor
- 10 Nm Ø 40 motor
- 13 Nm Ø 40 motor
- 13 Nm Ø 60 motor
- 23 Nm Ø 60 motor

Standard equipment includes:

- white PVC box with insulation in sizes customized to the height of the roller shutter with angle irons for building in from the outside and from the inside.
- white revision flap in a bottom part of the box.
- a winding pipe (shaft) with a diameter of 40 or 60 mm, depending on the dimensions of the roller shutter.
- Pa 39 profile, perforated, standard colour
- manual control for tape - white box coiler, up to 12 kg.
- 56 mm end slat in standard colour with a rubber seal.
- white PVC guides.
- cable extraction outside in electric roller shutter on the side of the box.
- steel hangers.
- stopper.
- packing of box and guides with stretch wrap.

For an extra charge or optional (no information on order form means that the standard will be produce):

- OWAL box with a revision flap in the front part of the box 0 € pcs.
- white revision flap in a front part of the box (no surcharge) 0 € pcs.
- box coiler in brown or anthracite colour (no surcharge) 0 € pcs.
- tape in brown or anthracite colour (no surcharge) 0 € pcs.
- curtain profile without perforation (no surcharge) 0 € pcs.
- box without the angle irons for building in (no surcharge) 0 € pcs.
- bottom end caps of the guides 1 € set
- packing in corrugated cardboard 4 € rm
- packing in a 6 mm thick cardboard 15 € rm
- packing the box and the curtain profile separately 15 € rm
- winder crank for a tape up to 20 kg 30 € set
- end slat varnishing 15 € pcs.
- surcharge to curtain profile - woodlike colour 5 € m²
- surcharge to curtain profile - non-standard colour 8 € m²
- automatic lock (only roller shutters without motor) 30 € set
- spring 10 kg Ø 40 + cylinder lock 94 € set
- spring 15 kg Ø 40 + cylinder lock 106 € set
- spring 15 kg Ø 60 + cylinder lock 112 € set
- spring 24 kg Ø 60 + cylinder lock 115 € set
- steel reinforcement console (no possibility to install in 160 Box) 33 € pcs.
- mounting anchor for connecting the box with the headroom 0,5 € pcs.
- Neopor insulation 7 € rm
- rolling insect screen 65 € m²
- (max 1600mm wide and 2400mm high; may increase the size of the box)
- drive selected according to legend, drives prices on pages 50 - 57.
- remote control with the appropriate number of channels, prices on pages 50 - 57.
- push-button switch selectable on pages 50 - 57



Price list for BECLEVER roller shutters in woodlike colour, profile PA39

		Net prices in EUR																									
Box with Ø60 pipe	Box with Ø40 pipe	Width Height	500	600	700	800	900	1000	1100	1200	1300	1400	1500	1600	1700	1800	1900	2000	2100	2200	2300	2400	2500	2600	2700		
160	160	500	87	95	102	109	115	123	129	136	144	151	157	163	185	194	203	213	222	231	240	250	259	268	277		
		600	92	100	107	115	122	129	137	144	152	159	166	184	201	211	220	231	241	250	260	271	281	291	301		
		700	97	105	112	120	128	136	144	152	159	167	184	205	216	227	238	248	259	270	281	291	303	314	324		
		800	99	108	116	124	133	141	149	157	175	185	196	217	229	240	252	263	274	285	297	308	320	332	344		
		900	104	113	121	129	138	147	155	175	187	199	209	231	244	256	268	281	293	305	317	329	342	355	367		
		1000	106	115	125	134	143	152	172	184	196	209	221	243	257	270	282	295	308	321	334	347	359	372	385		
		1100	112	121	130	140	150	170	183	196	209	222	235	258	272	285	299	313	327	340	354	368	381	395	408		
		1200	115	126	136	145	166	180	193	207	221	235	249	273	288	302	316	331	345	360	374	388	404	418	432		
		1300	119	129	139	159	173	188	202	217	231	245	260	284	300	315	331	345	360	376	391	406	421	435	450		
		1400	123	133	144	167	182	197	212	228	243	258	274	299	316	331	347	363	379	395	411	427	443	459	474		
1500	128	137	158	174	190	205	222	237	254	270	284	312	328	345	361	378	394	411	427	444	460	477	495				
1600	132	142	166	182	199	216	232	249	265	283	299	327	344	361	378	396	413	431	448	465	483	500	517				
1700	137	154	171	189	206	224	241	258	276	293	311	339	356	374	392	411	428	447	464	483	500	519	536				
1800	143	161	179	197	216	233	252	270	288	306	324	353	371	391	409	428	447	466	484	503	522	541	560				
200	200	1900	148	166	185	204	223	242	260	279	298	317	336	365	385	404	424	443	462	482	501	521	540	559	578		
		2000	152	172	192	212	231	251	271	291	310	330	349	379	400	420	440	460	481	501	521	541	562	582	602		
		2100	159	180	200	220	241	261	281	302	322	343	363	394	415	436	458	479	500	521	541	563	584	605	626		
		2200	164	185	206	227	248	270	291	312	332	353	375	406	428	449	471	493	515	536	558	580	601	623	646		
		2300	169	191	214	235	257	279	301	323	345	367	388	420	443	465	488	511	533	556	578	601	623	646			
		2400	175	197	219	242	264	287	310	332	355	377	400	433	456	479	502	525	548	572	595	618	642				
		2500	180	203	227	250	273	297	320	343	367	391	413	447	471	495	519	543	567	591	615	639					
		2600	182	206	230	255	278	302	327	350	374	398	422	457	481	505	531	555	579	604	629						
		2700	188	212	237	263	287	312	336	361	386	411	435	471	496	522	547	573	598	623							
		2800	193	219	244	271	296	321	347	372	398	424	449	485	512	538	564	590	616								
240	240	2900	199	225	251	277	303	329	356	382	408	434	460	497	524	551	578	605									
		3000	204	230	257	283	311	337	365	392	419	445	471	509	537	564	592	619									

Surcharge for guides
aluminum varnished in RAL colour (for 2 pcs.)
16
19
22
25
28
31
34
38
41
44
47
50
53
56
59
63
66
69
72
75
78
81
84
88
91
94

Surcharges:	Winding pipe Ø40													Winding pipe Ø60												
Non-standard revision flap	5	6	7	8	9	10	11	12	13	14	15	16	17	18	19	20	21	22	23	24	25	26	27			
Non-standard outer part	7	8	9	10	12	13	14	16	17	18	20	21	22	23	25	26	27	29	30	31	33	34	35			
Non-standard internal part	7	8	9	10	12	13	14	16	17	18	20	21	22	23	25	26	27	29	30	31	33	34	35			
Woodlike end slat RENOLIT	1	1	1	1	1	2	2	2	2	2	2	2	3	3	3	3	3	3	3	4	4	4	4			
Cover plate for ALU box from the outside	28	33	39	44	50	55	61	66	72	77	83	88	94	99	105	110	116	121	127	132	138	143	149			
Steel strengthening the front and bottom profile	4	5	6	7	8	9	10	11	11	12	13	14	15	16	17	18	18	19	20	21	22	23	24			
Block hangers	2 pieces / 18 €						3 pieces / 27 €						4 pieces / 36 €						5 pieces / 45 €							

Specification
- 10 Nm short Ø 40 motor
- 10 Nm Ø 40 motor
- 13 Nm Ø 40 motor
- 13 Nm Ø 60 motor
- 23 Nm Ø 60 motor

Standard equipment includes:

- white PVC box with insulation in sizes customized to the height of the roller shutter with angle irons for building in from the outside and from the inside.
- white revision flap in a bottom part of the box.
- a winding pipe (shaft) with a diameter of 40 or 60 mm, depending on the dimensions of the roller shutter.
- profile Pa 39 perforated, woodlike colour.
- manual control for tape - white box coiler, up to 12 kg.
- 56 mm high end slat varnished in woodlike colour with a rubber seal.
- PVC woodlike or non-standard colour guides.
- cable extraction outside in electric roller shutter on the side of the box.
- steel hangers.
- stopper.
- packing of box and guides with stretch wrap.

For an extra charge or optional (no information on order form means that the standard will be produce):

- OWAL box with a revision flap in the front part of the box 0 € pcs.
- white revision flap in a front part of the box (no surcharge) 0 € pcs.
- box coiler in brown or anthracite colour (no surcharge) 0 € pcs.
- tape in brown or anthracite colour (no surcharge) 0 € pcs.
- curtain profile without perforation (no surcharge) 0 € pcs.
- box without the angle irons for building in (no surcharge) 0 € pcs.
- bottom end caps of the guides 1 € set
- packing in corrugated cardboard 4 € rm
- packing in a 6 mm thick cardboard 15 € rm
- packing the box and the curtain profile separately 15 € rm
- winder crank for a tape up to 20 kg 30 € set
- end slat varnishing 15 € pcs.
- surcharge to curtain profile - non-standard colour 8 € m²
- automatic lock (only roller shutters without motor) 30 € set
- spring 10 kg Ø 40 + cylinder lock 94 € set
- spring 15 kg Ø 40 + cylinder lock 106 € set
- spring 15 kg Ø 60 + cylinder lock 112 € set
- spring 24 kg Ø 60 + cylinder lock 115 € set
- steel reinforcement console (no possibility to install in 160 Box) 33 € pcs.
- mounting anchor for connecting the box with the headroom 0,5 € pcs.
- Neopor insulation 7 € rm
- rolling insect screen 65 € m²
- (max 1600mm wide and 2400mm high; may increase the size of the box)
- drive selected according to legend, drives prices on pages 50 - 57.
- remote control with the appropriate number of channels, prices on pages 50 - 57.
- push-button switch selectable on pages 50 - 57



Price list for BECLEVER roller shutters in a non-standard colour, PA39 profile

Net prices in EUR

Box with Ø60 pipe	Box with Ø40 pipe	Width Height	500	600	700	800	900	1000	1100	1200	1300	1400	1500	1600	1700	1800	1900	2000	2100	2200	2300	2400	2500	2600	2700
160	160	500	111	120	130	138	147	156	165	173	183	191	199	207	236	247	258	271	282	293	305	318	329	340	351
		600	116	126	136	145	155	164	174	183	193	202	211	234	255	268	280	293	306	318	330	344	356	369	382
		700	123	133	143	152	162	173	182	193	202	212	234	261	275	288	302	315	329	343	356	371	384	399	412
		800	126	137	147	158	168	179	189	199	222	236	249	276	290	305	320	334	348	363	377	392	406	421	437
		900	132	143	154	165	175	186	197	222	237	252	266	294	310	325	341	356	372	387	403	419	434	450	467
		1000	135	147	159	170	182	193	218	234	250	265	281	309	326	343	358	375	391	407	424	440	456	473	490
		1100	142	154	165	178	190	216	232	249	265	282	298	328	346	363	380	398	415	432	450	467	485	501	518
		1200	147	160	172	184	211	228	245	264	281	298	316	347	365	384	402	420	439	457	475	493	512	530	549
		1300	151	164	176	202	220	238	257	276	294	312	330	361	381	400	420	439	458	477	497	516	535	553	571
		1400	157	169	183	212	231	251	270	289	309	328	348	380	401	421	441	461	481	501	522	542	562	582	602
		1500	163	174	201	221	241	261	282	302	322	343	361	396	417	438	458	480	501	522	542	564	585	606	628
		1600	168	180	211	231	253	274	295	316	337	359	379	415	437	458	480	503	524	547	569	591	613	635	657
		1700	174	196	217	240	262	284	306	328	350	372	394	430	452	475	499	521	544	568	590	613	636	659	681
		1800	181	205	227	250	274	296	320	343	366	388	411	449	472	496	520	544	568	592	615	639	663	687	711
200	200	1900	187	211	235	259	283	307	330	355	378	402	426	463	488	513	538	562	587	612	636	661	685	710	734
		2000	193	219	244	269	294	319	344	369	394	419	444	481	508	533	560	584	610	636	662	687	713	739	764
		2100	202	228	254	280	306	332	358	384	409	436	462	500	528	554	582	608	635	661	687	715	742	768	795
		2200	208	235	262	288	315	343	369	396	422	449	476	516	543	571	599	626	654	681	709	736	764	792	820
		2300	215	243	271	298	326	355	382	410	438	466	493	534	563	591	620	649	677	706	734	763	792	821	
		2400	222	250	278	307	336	365	393	421	450	479	508	549	579	609	637	667	697	726	756	785	815		
		2500	229	258	288	318	347	377	406	436	466	496	524	568	599	629	660	690	720	751	780	811			
		2600	231	262	293	323	354	384	415	445	475	505	535	580	611	642	674	704	736	768	799				
		2700	238	270	302	333	365	396	427	458	490	522	553	598	630	662	695	727	759	792					
		2800	246	278	310	343	376	408	440	473	505	538	570	616	650	683	716	750	783						
240	240	2900	253	285	319	352	385	419	452	486	518	551	584	632	666	700	734	768							
		3000	259	293	327	360	394	428	463	498	531	565	599	647	682	717	751	787							

Surcharge for guides	
aluminum varnished in RAL colour (for 2 pcs.)	16
	19
	22
	25
	28
	31
	34
	38
	41
	44
	47
	50
	53
	56
	59
	63
	66
	69
	72
	75
	78
	81
	84
	88
	91
	94

Surcharges:	Winding pipe Ø40										Winding pipe Ø60												
Non-standard revision flap	5	6	7	8	9	10	11	12	13	14	15	16	17	18	19	20	21	22	23	24	25	26	27
Non-standard outer part	7	8	9	10	12	13	14	16	17	18	20	21	22	23	25	26	27	29	30	31	33	34	35
Non-standard internal part	7	8	9	10	12	13	14	16	17	18	20	21	22	23	25	26	27	29	30	31	33	34	35
Woodlike end slat RENOLIT	1	1	1	1	1	2	2	2	2	2	2	2	3	3	3	3	3	3	3	4	4	4	4
Cover plate for ALU box from the outside	28	33	39	44	50	55	61	66	72	77	83	88	94	99	105	110	116	121	127	132	138	143	149
Steel strengthening the front and bottom profile	4	5	6	7	8	9	10	11	11	12	13	14	15	16	17	18	18	19	20	21	22	23	24
Block hangers	2 pieces / 18 €					3 pieces / 27 €					4 pieces / 36 €					5 pieces / 45 €							

Specification	
- 10 Nm short Ø 40 motor	
- 10 Nm Ø 40 motor	
- 13 Nm Ø 40 motor	
- 13 Nm Ø 60 motor	
- 23 Nm Ø 60 motor	

Standard equipment includes:

- white PVC box with insulation in sizes customized to the height of the roller shutter with angle irons for building in from the outside and from the inside.
- white revision flap in a bottom part of the box.
- a winding pipe (shaft) with a diameter of 40 or 60 mm, depending on the dimensions of the roller shutter.
- Pa 39 profile, perforated, non-standard colour.
- manual control for tape - white box coiler, up to 12 kg.
- 56 mm end slat in non-standard colour with a rubber seal.
- PVC woodlike or non-standard colour guides.
- cable extraction outside in electric roller shutter on the side of the box.
- steel hangers.
- stopper.
- packing of box and guides with stretch wrap.

For an extra charge or optional (no information on order form means that the standard will be produce):

- OWAL box with a revision flap in the front part of the box 0 € pcs.
- white revision flap in a front part of the box (no surcharge) 0 € pcs.
- box coiler in brown or anthracite colour (no surcharge) 0 € pcs.
- tape in brown or anthracite colour (no surcharge) 0 € pcs.
- curtain profile without perforation (no surcharge) 0 € pcs.
- box without the angle irons for building in (no surcharge) 0 € pcs.
- bottom end caps of the guides 1 € set
- packing in corrugated cardboard 4 € rm
- packing in a 6 mm thick cardboard 15 € rm
- packing the box and the curtain profile separately 15 € rm
- winder crank for a tape up to 20 kg 30 € set
- end slat varnishing 15 € pcs.
- automatic lock (only roller shutters without motor) 30 € set
- spring 10 kg Ø 40 + cylinder lock 94 € set
- spring 15 kg Ø 40 + cylinder lock 106 € set
- spring 15 kg Ø 60 + cylinder lock 112 € set
- spring 24 kg Ø 60 + cylinder lock 115 € set
- steel reinforcement console (no possibility to install in 160 Box) 33 € pcs.
- mounting anchor for connecting the box with the headroom 0,5 € pcs.
- Neopor insulation 7 € rm
- rolling insect screen 65 € m²
- (max 1600mm wide and 2400mm high; may increase the size of the box)
- drive selected according to legend, drives prices on pages 50 - 57.
- remote control with the appropriate number of channels, prices on pages 50 - 57.
- push-button switch selectable on pages 50 - 57

BECLEVER on a 43 mm aluminum profile

- PVC box, insulated.
- 60 mm wide PVC guides or ALU for an extra charge.
- 43 mm aluminum profile filled with polyurethane foam (weight 2,6 kg/m³).
- maximum dimensions: width 2700 mm, height 3000 mm (for 1 class wind resistance according to EN13659).
- manual drive in the form of a box coiler for tape (maximum curtain profile weight: up to 12 kg).
- maximum roller shutter surface 9 m².
- recommended by the system provider stability for the curtain is obtained for surface up to 7 m². Above this value slight undulations of the curtain may occur - however, this does not affect functionality and roller shutter fulfills all criteria specified by the norm.



BECLEVER

43 mm „PA-43“ aluminum profile.

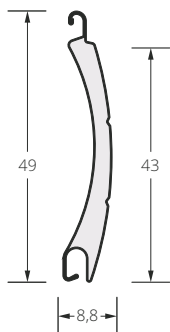

"PG-02" guide.

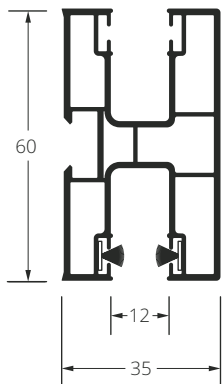

Colour	symbol	RAL*	Curtain profile	End slat	PVC Guide	Box	Revision flap	ALU Guide	Guide distance	Box BeClever OWAL	Cover plate for box (from the outside)
standard colours											
silver	01	9006	✓	✓				2	2		2
white	02	9016	✓	✓	✓	✓	✓	2	2	✓	2
grey	03	7038	✓	✓				2	2		2
dark beige	04	1019	4								
beige	05	1013	✓	✓							
dark brown	08	8019	✓	✓				2	2		2
brown	09	8014	✓	✓				2	2		2
crème white	15	9001	✓	1							
ivory	16	1015	✓	2							
ultra white	22		1	1							
anthracite grey	23	7016	✓	✓				2	2		2
light grey	31	7047	✓	1				2	2		2
woodlike (surcharge)											
dark wood	06		4								
mahogany	26		✓								
walnut	28		✓	✓							
golden oak	30		✓	✓							
swamp oak	36		✓								
winchester	52		✓								
woodlike, foil, renolite (surchge)											
grey	03R	715505			✓	1	1				1
anthracite	23R	701605		1	✓	1	✓				1
anthracite smooth	23RG	701605-083		1	✓	1	1				1
mahogany	26R	2065021		✓	✓	1	1				1
walnut	28R	2178007		✓	✓	1	✓		✓		1
golden oak	30R	2178001		✓	✓	1	✓		✓		1
basalt grey	33R	701205			1	1	1				1
basalt grey smooth	33RG	701205-083			1	1	1				1
quartz grey	34R	701205			1	1	1				1
swamp oak	36R	2052089		✓	✓	1	✓				1
winchester	52R	49240		✓	✓	1	✓				1
palisander	54R	851805			1	1	1				1
chocolate brown	55R	887505			1	1	1				1
crème white	66R	137905			1	1	1				1
non-standard (surcharge)											
black	20	9005	1	2				2	2		2
basalt grey	33	7012	✓	2				2	2		2
quartz grey	34	7039	✓	✓				2	2		2
concrete grey	35	7023	4	2				2	2		2
grey aluminum	37	9007	1	2				2	2		2

* RAL numbers mean the colours similar to real, the most reliable way to verify is our colour sampler.

1. – longer realization term.
2. – painting surcharge, longer realization term.
4. – minimum order is 15 m².



Price list for BECLEVER roller shutters in standard colour, PA43 profile

		Net prices in EUR																															
Box with Ø60 pipe	Box with Ø40 pipe	Width Height	500	600	700	800	900	1000	1100	1200	1300	1400	1500	1600	1700	1800	1900	2000	2100	2200	2300	2400	2500	2600	2700	Surcharge for guides							
																											non-standard or woodlike colour (for 2 pcs.)	aluminum varnished in RAL colour (for 2 pcs.)	distance varnished in RAL colour				
160	160	500	90	94	98	105	112	119	125	132	139	146	148	162	177	185	194	203	212	221	230	239	248	265	273	5	16	11					
		600	93	98	103	111	118	126	133	140	148	155	162	180	192	202	211	222	231	241	250	261	270	279	288	6	19	13					
		700	96	103	109	116	124	132	140	148	156	164	177	197	208	218	229	240	250	261	271	281	280	298	314	8	22	15					
		800	99	106	112	121	129	137	146	154	168	178	189	209	221	233	244	255	265	277	289	300	311	322	333	9	25	18					
		900	104	111	117	127	135	144	153	168	180	191	203	225	237	249	261	274	285	297	309	321	334	346	358	10	28	20					
		1000	107	114	121	131	140	149	166	178	190	202	215	237	250	263	276	289	301	314	327	340	353	366	378	11	31	22					
		1100	111	119	127	137	147	164	177	189	202	216	229	252	265	280	293	308	321	335	348	363	376	389	402	12	34	24					
		1200	115	123	131	143	159	173	187	201	215	229	243	267	282	296	311	325	340	355	369	384	399	413	428	13	38	26					
		1300	117	127	136	152	166	181	196	210	225	240	255	279	295	310	325	341	356	371	387	402	417	432	446	14	41	29					
		1400	120	132	141	160	175	190	206	222	237	253	268	295	311	327	342	359	375	391	407	424	440	456	472	15	44	31					
		1500	122	135	150	166	183	199	216	231	247	264	280	307	324	340	358	374	391	408	425	442	459	475	491	16	47	33					
		1600	125	138	157	174	192	209	225	243	260	277	295	321	340	357	375	392	411	428	446	464	482	500	517	17	50	35					
		1700	128	145	163	181	199	217	235	252	271	288	306	334	353	371	389	408	426	445	464	482	500	519	537	18	53	37					
		1800	133	152	170	189	208	226	244	263	283	301	319	349	368	388	407	426	445	465	484	503	523	543	562	19	56	40					
		200	200	1900	137	157	176	196	216	235	254	273	292	312	332	361	381	401	421	442	462	481	501	522	541	561	581	20	59	42			
				2000	142	165	183	204	224	244	264	284	305	325	345	376	397	419	439	460	481	501	523	544	564	584	606	22	63	44			
				2100	150	169	190	211	233	255	275	297	317	338	360	391	413	434	457	479	500	522	544	565	588	609	631	23	66	46			
				2200	154	175	192	218	240	262	284	306	328	349	372	404	426	449	471	493	516	538	561	583	607	629	651	24	69	48			
2300	158			181	203	226	249	272	294	317	339	363	385	419	441	465	488	512	536	558	582	606	629	652	675	25	72	51					
2400	163			186	209	233	256	280	303	327	350	373	397	431	454	479	503	527	551	575	600	623	648	672	696	26	75	53					
2500	165			192	216	241	265	289	313	337	363	387	411	446	470	496	521	546	570	595	621	645	669	693	718	27	78	55					
2600	170			195	219	244	270	295	319	345	369	395	420	455	481	506	533	558	583	609	635	660	685	710	736	28	81	57					
2700	175			200	226	252	278	304	330	356	382	407	434	469	496	523	550	576	602	629	656	683	710	737	763	29	84	59					
2800	180			206	233	261	287	314	340	367	394	421	447	484	512	540	567	595	622	650	677	705	732	760	787	30	88	62					
240	240	2900	184	212	239	267	294	321	349	376	405	432	460	497	525	555	581	610	638	666	694	723	751	779	807	31	91	64					
		3000	188	217	245	273	301	330	359	386	414	442	471	509	539	571	596	625	653	682	710	739	768	796	32	94	66						
Surcharges:			Winding pipe Ø40														Winding pipe Ø60																
Non-standard revision flap			5	6	7	8	9	10	11	12	13	14	15	16	17	18	19	20	21	22	23	24	25	26	27								
Non-standard outer part			7	8	9	10	12	13	14	16	17	18	20	21	22	23	25	26	27	29	30	31	33	34	35								
Non-standard internal part			7	8	9	10	12	13	14	16	17	18	20	21	22	23	25	26	27	29	30	31	33	34	35								
Woodlike end slat			4	5	5	6	7	8	8	9	10	11	11	12	13	14	14	15	16	17	17	18	19	20	20								
Woodlike end slat RENOLIT			4	5	6	7	8	9	9	10	11	12	13	14	15	15	16	17	18	19	20	20	21	22	23								
Cover plate for ALU box from the outside			28	33	39	44	50	55	61	66	72	77	83	88	94	99	105	110	116	121	127	132	138	143	149								
Steel strengthening the front and bottom profile			4	5	6	7	8	9	10	11	11	12	13	14	15	16	17	18	18	19	20	21	22	23	24								
Block hangers			2 pieces / 18 €							3 pieces / 27 €							4 pieces / 36 €							5 pieces / 45 €									

Surcharge for guides		
non-standard or woodlike colour (for 2 pcs.)	aluminum varnished in RAL colour (for 2 pcs.)	distance varnished in RAL colour
5	16	11
6	19	13
8	22	15
9	25	18
10	28	20
11	31	22
12	34	24
13	38	26
14	41	29
15	44	31
16	47	33
17	50	35
18	53	37
19	56	40
20	59	42
22	63	44
23	66	46
24	69	48
25	72	51
26	75	53
27	78	55
28	81	57
29	84	59
30	88	62
31	91	64
32	94	66

Specification

- 10 Nm short Ø 40 motor
- 10 Nm Ø 40 motor
- 13 Nm Ø 40 motor
- 13 Nm Ø 60 motor
- 23 Nm Ø 60 motor

Standard equipment includes:

- white PVC box with insulation in sizes customized to the height of the roller shutter with angle irons for building in from the outside and from the inside.
- white revision flap in a bottom part of the box.
- a winding pipe (shaft) with a diameter of 40 or 60 mm, depending on the dimensions of the roller shutter.
- Pa 43 profile, perforated, standard colour
- manual control for tape - white box coiler, up to 12 kg.
- 56 mm end slat in standard colour with a rubber seal.
- white PVC guides.
- cable extraction outside in electric roller shutter on the side of the box.
- steel hangers.
- stopper.
- packing of box and guides with stretch wrap.

For an extra charge or optional (no information on order form means that the standard will be produce):

- OWAL box with a revision flap in the front part of the box 0 € pcs.
- white revision flap in a front part of the box (no surcharge) 0 € pcs.
- box coiler in brown or anthracite colour (no surcharge) 0 € pcs.
- tape in brown or anthracite colour (no surcharge) 0 € pcs.
- curtain profile without perforation (no surcharge) 0 € pcs.
- box without the angle irons for building in (no surcharge) 0 € pcs.
- bottom end caps of the guides 1 € set
- packing in corrugated cardboard 4 € rm
- packing in a 6 mm thick cardboard 15 € rm
- packing the box and the curtain profile separately 15 € rm
- winder crank for cord or tape up to 20 kg 30 € set
- end slat varnishing 15 € pcs.
- surcharge to curtain profile - woodlike colour 7 € m²
- surcharge to curtain profile - non-standard colour 10 € m²
- automatic lock (only roller shutters without motor) 30 € set
- spring 10 kg Ø 40 + cylinder lock 94 € set
- spring 15 kg Ø 40 + cylinder lock 106 € set
- spring 15 kg Ø 60 + cylinder lock 112 € set
- spring 24 kg Ø 60 + cylinder lock 115 € set
- steel reinforcement console (no possibility to install in 160 Box) 33 € pcs.
- mounting anchor for connecting the box with the headroom 0,5 € pcs.
- Neopor insulation 7 € rm
- rolling insect screen 65 € m²
- (max 1600mm wide and 2400mm high; may increase the size of the box)
- drive selected according to legend, drives prices on pages 50 - 57.
- remote control with the appropriate number of channels, prices on pages 50 - 57.
- push-button switch selectable on pages 50 - 57



Price list for BECLEVER roller shutters in woodlike colour, PA43 profile

		Net prices in EUR																									
Box with Ø60 pipe	Box with Ø40 pipe	Width Height	500	600	700	800	900	1000	1100	1200	1300	1400	1500	1600	1700	1800	1900	2000	2100	2200	2300	2400	2500	2600	2700		
160	160	500	90	99	107	114	122	129	137	145	152	160	165	173	197	206	216	227	236	245	256	266	276	285	295		
		600	96	105	113	121	129	137	146	153	162	170	178	197	215	225	236	247	257	268	279	290	301	312	322		
		700	102	110	119	128	136	145	154	163	171	180	199	220	232	243	256	267	278	291	302	314	326	338	350		
		800	105	114	124	133	143	152	161	170	189	200	212	235	247	259	272	284	296	309	321	334	347	360	373		
		900	110	120	129	140	149	159	169	189	202	216	228	251	264	278	291	305	318	332	345	358	372	386	400		
		1000	113	124	135	145	155	165	187	200	214	227	241	265	279	294	308	322	336	350	365	378	393	407	422		
		1100	119	129	141	152	163	185	199	214	228	243	257	282	297	312	327	343	358	373	388	404	419	433	448		
		1200	124	135	147	158	181	196	211	227	242	257	273	298	315	331	347	363	379	395	411	427	444	460	476		
		1300	128	140	151	172	189	205	221	237	254	270	285	313	330	347	364	380	397	414	431	448	464	481	497		
		1400	133	145	157	182	199	216	233	250	267	284	302	329	348	365	383	400	419	436	454	472	489	507	524		
1500	138	149	172	190	208	225	243	262	280	298	315	343	363	380	399	419	436	455	473	492	511	529	549				
1600	144	155	181	199	219	237	256	275	294	313	331	361	380	400	419	439	458	478	497	517	536	556	575				
1700	149	168	187	207	227	247	266	285	305	325	345	375	395	415	436	456	476	497	517	537	557	578	598				
1800	155	175	196	216	237	257	278	299	319	340	360	392	412	434	455	477	498	519	540	561	582	603	625				
200	200	1900	160	181	203	224	245	267	288	310	331	352	374	405	427	449	472	494	515	538	559	582	603	625	647		
		2000	166	189	211	233	256	278	300	322	345	367	389	422	445	468	491	514	537	560	583	606	629	652	674		
		2100	173	196	220	243	266	290	312	336	359	383	405	439	463	487	511	535	559	582	606	630	654	678	702		
		2200	179	203	227	250	275	299	323	347	371	395	419	453	478	503	527	552	576	601	626	650	675	700	725		
		2300	184	210	236	259	284	310	335	359	385	410	434	469	496	521	547	573	598	623	649	675	700	726	751		
		2400	191	216	242	268	294	319	345	371	396	423	448	484	510	537	563	589	616	643	669	695	722	748	775		
		2500	197	223	250	277	303	330	357	384	411	437	463	501	528	555	583	610	637	665	691	719	746	774	802		
		2600	200	227	255	282	310	337	365	392	419	447	473	512	540	568	596	624	652	681	709	737	764	792	820		
		2700	206	235	263	291	320	348	376	405	433	461	489	528	558	587	616	645	674	703	732	762	791	820	850		
		2800	212	241	271	300	330	359	388	417	447	476	505	545	575	605	635	665	695	725	756	785	816	846	876		
240	240	2900	218	248	278	308	338	368	399	428	459	488	519	560	590	621	651	682	713	744	775	805	836	867	898		
		3000	224	255	285	315	347	377	409	440	470	501	532	574	605	636	668	700	731	764	796	828	859	892			

Surcharge for guides	
aluminum varnished in RAL colour (for 2 pcs.)	16
	19
	22
	25
	28
	31
	34
	38
	41
	44
	47
	50
	53
	56
	59
	63
	66
	69
	72
	75
	78
	81
	84
	88
	91
	94

Surcharges:	Winding pipe Ø40													Winding pipe Ø60												
Non-standard revision flap	5	6	7	8	9	10	11	12	13	14	15	16	17	18	19	20	21	22	23	24	25	26	27			
Non-standard outer part	7	8	9	10	12	13	14	16	17	18	20	21	22	23	25	26	27	29	30	31	33	34	35			
Non-standard internal part	7	8	9	10	12	13	14	16	17	18	20	21	22	23	25	26	27	29	30	31	33	34	35			
Woodlike end slat RENOLIT	1	1	1	1	1	2	2	2	2	2	2	2	3	3	3	3	3	3	3	4	4	4	4			
Cover plate for ALU box from the outside	28	33	39	44	50	55	61	66	72	77	83	88	94	99	105	110	116	121	127	132	138	143	149			
Steel strengthening the front and bottom profile	4	5	6	7	8	9	10	11	11	12	13	14	15	16	17	18	18	19	20	21	22	23	24			
Block hangers	2 pieces / 18 €							3 pieces / 27 €							4 pieces / 36 €							5 pieces / 45 €				

Specification	
- 10 Nm short Ø 40 motor	
- 10 Nm Ø 40 motor	
- 13 Nm Ø 40 motor	
- 13 Nm Ø 60 motor	
- 23 Nm Ø 60 motor	

Standard equipment includes:

- white PVC box with insulation in sizes customized to the height of the roller shutter with angle irons for building in from the outside and from the inside.
- white revision flap in a bottom part of the box.
- a winding pipe (shaft) with a diameter of 40 or 60 mm, depending on the dimensions of the roller shutter.
- profile Pa 43 perforated, woodlike colour
- manual control for tape - white box coiler, up to 12 kg.
- 56 mm high end slat varnished in woodlike colour with a rubber seal.
- PVC woodlike or non-standard colour guides.
- cable extraction outside in electric roller shutter on the side of the box.
- steel hangers.
- stopper.
- packing of box and guides with stretch wrap.

For an extra charge or optional (no information on order form means that the standard will be produce):

- OWAL box with a revision flap in the front part of the box 0 € pcs.
- white revision flap in a front part of the box (no surcharge) 0 € pcs.
- box coiler in brown or anthracite colour (no surcharge) 0 € pcs.
- tape in brown or anthracite colour (no surcharge) 0 € pcs.
- curtain profile without perforation (no surcharge) 0 € pcs.
- box without the angle irons for building in (no surcharge) 0 € pcs.
- bottom end caps of the guides 1 € set
- packing in corrugated cardboard 4 € rm
- packing in a 6 mm thick cardboard 15 € rm
- packing the box and the curtain profile separately 15 € rm
- winder crank for a tape up to 20 kg 30 € set
- end slat varnishing 15 € pcs.
- surcharge to curtain profile - non-standard colour 3 € m²
- automatic lock (only roller shutters without motor) 30 € set
- spring 10 kg Ø 40 + cylinder lock 94 € set
- spring 15 kg Ø 40 + cylinder lock 106 € set
- spring 15 kg Ø 60 + cylinder lock 112 € set
- spring 24 kg Ø 60 + cylinder lock 115 € set
- steel reinforcement console (no possibility to install in 160 Box) 33 € pcs.
- mounting anchor for connecting the box with the headroom 0,5 € pcs.
- Neopor insulation 7 € rm
- rolling insect screen 65 € m²
(max 1600mm wide and 2400mm high; may increase the size of the box)
- drive selected according to legend, drives prices on pages 50 - 57.
- remote control with the appropriate number of channels, prices on pages 50 - 57.
- push-button switch selectable on pages 50 - 57

Price list for BECLEVER roller shutters in a non-standard colour, PA43 profile

		Net prices in EUR																									
Box with Ø60 pipe	Box with Ø40 pipe	Width Height	500	600	700	800	900	1000	1100	1200	1300	1400	1500	1600	1700	1800	1900	2000	2100	2200	2300	2400	2500	2600	2700		
160	160	500	113	123	134	143	152	162	171	181	190	200	208	217	246	258	270	283	295	307	319	333	344	356	368		
		600	120	131	141	151	161	172	182	192	203	212	223	246	268	282	295	308	322	335	348	363	376	389	403		
		700	127	138	149	159	170	182	192	204	214	225	248	276	290	304	320	333	348	363	378	392	408	422	437		
		800	131	142	154	166	178	189	202	213	236	250	264	293	308	324	340	356	371	387	402	417	434	450	466		
		900	138	149	162	174	186	198	211	237	253	269	284	314	330	347	365	381	397	414	431	448	465	482	500		
		1000	141	155	168	181	194	207	233	250	268	284	302	331	349	367	385	402	420	438	456	473	491	509	527		
		1100	149	162	176	189	204	231	249	268	284	303	321	352	371	391	409	428	447	466	485	504	523	541	560		
		1200	155	169	184	198	226	244	264	283	303	322	342	373	393	414	434	454	474	494	514	534	554	575	595		
		1300	159	174	189	216	237	257	277	297	318	338	357	391	413	433	454	475	496	517	539	560	581	601	621		
		1400	166	181	196	228	249	270	291	313	334	356	377	412	434	457	479	501	523	545	567	589	612	634	656		
1500	172	186	215	237	260	282	304	327	349	372	393	429	453	476	499	523	545	568	591	615	638	662	686				
1600	179	194	226	249	273	297	320	343	367	391	414	451	475	500	524	548	573	598	621	646	671	695	719				
1700	186	210	234	259	283	308	333	357	382	406	431	469	493	519	544	570	595	621	646	672	697	722	747				
1800	193	219	244	271	296	322	348	373	399	425	450	490	515	543	568	596	622	649	675	701	728	754	781				
200	200	1900	200	227	253	280	307	333	359	387	414	440	467	507	534	562	589	617	644	672	699	727	754	782	809		
		2000	207	236	263	292	320	348	375	403	432	459	487	528	556	585	614	642	671	699	729	757	786	815	843		
		2100	216	245	275	303	333	362	391	420	448	478	507	549	579	608	639	669	698	728	758	788	818	847	878		
		2200	223	253	283	313	343	373	403	434	463	493	524	567	598	628	659	690	720	751	782	813	844	875	906		
		2300	230	263	294	324	355	388	418	449	481	512	543	587	620	651	683	716	747	779	811	843	876	907	940		
		2400	239	271	302	334	367	399	432	463	495	528	560	605	638	671	703	737	770	803	836	868	902	935	969		
		2500	246	279	313	346	379	413	446	480	513	547	579	626	660	694	729	763	796	831	864	899	933	968	1002		
		2600	250	284	318	353	387	421	456	490	524	558	592	641	675	710	746	781	815	851	886	921	955	990	1025		
		2700	257	293	328	365	399	434	470	506	541	577	612	661	697	733	770	806	842	879	915	952	989	1025	1062		
		2800	265	302	338	375	412	448	485	521	558	595	631	681	719	756	794	831	869	906	945	982	1020	1057	1095		
240	240	2900	273	310	348	385	423	460	498	536	574	610	648	699	737	776	814	853	891	930	969	1007	1045	1084	1123		
		3000	280	318	357	394	433	472	511	551	588	626	665	717	757	796	835	875	914	954	995	1035	1074	1114			

Surcharge for guides	
aluminum varnished in RAL colour (for 2 pcs.)	16
	19
	22
	25
	28
	31
	34
	38
	41
	44
	47
	50
	53
	56
	59
	63
	66
	69
	72
	75
	78
	81
	84
	88
	91
	94

Surcharges:	Winding pipe Ø40													Winding pipe Ø60												
Non-standard revision flap	5	6	7	8	9	10	11	12	13	14	15	16	17	18	19	20	21	22	23	24	25	26	27			
Non-standard outer part	7	8	9	10	12	13	14	16	17	18	20	21	22	23	25	26	27	29	30	31	33	34	35			
Non-standard internal part	7	8	9	10	12	13	14	16	17	18	20	21	22	23	25	26	27	29	30	31	33	34	35			
Woodlike end slat RENOLIT	1	1	1	1	1	2	2	2	2	2	2	2	3	3	3	3	3	3	3	4	4	4	4			
Cover plate for ALU box from the outside	28	33	39	44	50	55	61	66	72	77	83	88	94	99	105	110	116	121	127	132	138	143	149			
Steel strengthening the front and bottom profile	4	5	6	7	8	9	10	11	11	12	13	14	15	16	17	18	18	19	20	21	22	23	24			
Block hangers	2 pieces / 18 €							3 pieces / 27 €							4 pieces / 36 €							5 pieces / 45 €				

Specification	
- 10 Nm short Ø 40 motor	
- 10 Nm Ø 40 motor	
- 13 Nm Ø 40 motor	
- 13 Nm Ø 60 motor	
- 23 Nm Ø 60 motor	

Standard equipment includes:

- white PVC box with insulation in sizes customized to the height of the roller shutter with angle irons for building in from the outside and from the inside.
- white revision flap in a bottom part of the box.
- a winding pipe (shaft) with a diameter of 40 or 60 mm, depending on the dimensions of the roller shutter.
- Pa 43 profile, perforated, non-standard colour.
- manual control for tape - white box coiler, up to 12 kg.
- 56 mm high end slat in non-standard colour with a rubber seal.
- PVC woodlike or non-standard colour guides.
- cable extraction outside in electric roller shutter on the side of the box.
- steel hangers.
- stopper.
- packing of box and guides with stretch wrap.

For an extra charge or optional (no information on order form means that the standard will be produce):

- OWAL box with a revision flap in the front part of the box 0 € pcs.
- white revision flap in a front part of the box (no surcharge) 0 € pcs.
- box coiler in brown or anthracite colour (no surcharge) 0 € pcs.
- tape in brown or anthracite colour (no surcharge) 0 € pcs.
- curtain profile without perforation (no surcharge) 0 € pcs.
- box without the angle irons for building in (no surcharge) 0 € pcs.
- bottom end caps of the guides 1 € set
- packing in corrugated cardboard 4 € rm
- packing in a 6 mm thick cardboard 15 € rm
- packing the box and the curtain profile separately 15 € rm
- winder crank for a tape up to 20 kg 30 € set
- end slat varnishing 15 € pcs.
- automatic lock (only roller shutters without motor) 30 € set
- spring 10 kg Ø 40 + cylinder lock 94 € set
- spring 15 kg Ø 40 + cylinder lock 106 € set
- spring 15 kg Ø 60 + cylinder lock 112 € set
- spring 24 kg Ø 60 + cylinder lock 115 € set
- steel reinforcement console (no possibility to install in 160 Box) 33 € pcs.
- mounting anchor for connecting the box with the headroom 0,5 € pcs.
- Neopor insulation 7 € rm
- rolling insect screen 65 € m²
- (max 1600mm wide and 2400mm high; may increase the size of the box)
- drive selected according to legend, drives prices on pages 50 - 57.
- remote control with the appropriate number of channels, prices on pages 50 - 57.
- push-button switch selectable on pages 50 - 57

OPOTERM on a 39 mm aluminum profile

- PVC box, insulated.
- 60 mm wide PVC guides or ALU for an extra charge.
- 39 mm aluminum profile filled with polyurethane foam (weight 2,8 kg/m³).
- maximum dimensions of roller shutters or roller shutters sets:
 - single roller shutter, without reinforcements, box for building in or white: width 2000 mm, height 3800 mm.
 - single roller shutter, with reinforcements, box for building in or white: width 2500 mm, height 3800 mm.
 - set with reinforcements, console, box for building in or white: width 3200 mm, height 3800 mm.
 - single roller shutter, without reinforcements, box other than white: width 1600 mm, height 3800 mm.
 - single roller shutter, with reinforcements, box other than white: width 2000 mm, height 3800 mm.
 - set with reinforcements, console, box other than white: width 2500 mm, height 3800 mm
- (for 1 class wind resistance according to EN13659).
- manual drive in the form of a box coiler for tape (maximum curtain profile weight: up to 12 kg).
- maximum roller shutter surface 6 m².

39 mm „PA-39“ aluminum profile.

"PPD-60/12" guide.

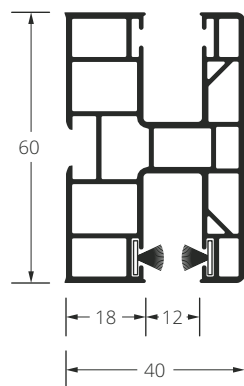
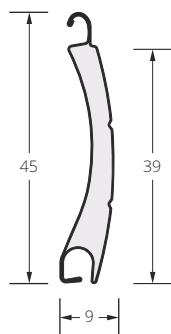

* RAL numbers mean the colours similar to real, the most reliable way to verify is our colour sampler.

1. – longer realization term.
2. – painting surcharge, longer realization term.
4. – minimum order is 15 m².

Colour	symbol	RAL*	Curtain profile	End slat	PVC Guide	Box	Revision flap	single chamber guide	oval lateral profile of box	lateral cover plate of box (PVC)	oval lateral cover plate of box (PVC)	
silver	01	9006	✓	✓								
white	02	9016	✓	✓	✓	✓	✓	1	✓	✓	✓	
grey	03	7038	✓	✓								
dark beige	04	1019	✓									
beige	05	1013	✓	✓								
dark brown	08	8019	✓	✓						1	1	
brown	09	8014	✓	✓								
crème white	15	9001	✓	1								
ivory	16	1015	✓	2								
ultra white	22		1	1								
anthracite grey	23	7016	✓	✓						1	1	
light grey	31	7047	✓	1								
dark wood	06		1									
light wood	07		1									
mahogany	26		✓									
walnut	28		✓	✓								
golden oak	30		✓	✓								
swamp oak	36		✓									
winchester	52		✓									
light oak	79											
anthracite	23R	701605		1	1	1	1	1				
anthracite smooth	25R	701605-083		✓	1							
mahogany	26R	2065021		✓	1	1	1					
walnut	28R	2178007		✓	1	1	1	1				
golden oak	30R	2178001		✓	1	1	1	1				
light grey	31R	725105			1							
basalt grey	33R	701205			1							
winchester	52R	49240		✓	1	1	1					
dark oak	53R	2052089		✓	1	1	1					
palisander	54R	851805			1							
chocolate brown	55R	887505			1							
grey	57R	715505			1							
swamp oak	58R	3167004			1							
crème white	66R	137905			1							
dark green	67R	612505			1							
light oak	79R						1					
red	12	3003	4	2								
green	13	6005	4	2								
fir green	17	6009	4	2								
steel blue	18	5011	4	2								
burgundy	19	3005	4	2								
black	20	9005	1	2								
basalt grey	33	7012	✓	2								
quartz grey	34	7039	✓	✓								
concrete grey	35	7023	4	2								
grey aluminum	37	9007	1	2								
white pearl matt	40		4	2								
light grey pearl matt	41			2								
grey pearl matt	42			2								
anthracite grey pearl matt	43		1	1								
dark grey pearl matt	44			2								

standard colours

woodlike (surcharge)

woodlike foil renolite (surcharge)

non-standard (surcharge)



OPOTERM

Price list for Opoterm roller shutters in the standard colour, profile PA39

Net prices in EUR

Box with Ø60 pipe	Box with Ø40 pipe	Width Height	Net prices in EUR																				
			500	600	700	800	900	1000	1100	1200	1300	1400	1500	1600	1700	1800	1900	2000	2100	2200	2300	2400	2500
170	170	500	89	93	96	102	108	116	121	127	134	140	141	155	170	178	186	195	204	212	220	229	237
		600	92	96	100	107	114	120	127	134	141	147	154	172	184	192	202	211	220	229	238	248	256
		700	94	100	104	112	119	126	133	140	147	155	167	188	197	207	217	227	237	247	256	266	289
		800	97	102	108	115	122	130	138	145	158	168	178	198	208	220	230	240	250	261	271	282	292
		900	101	106	112	120	128	135	144	158	168	179	190	211	222	233	245	256	267	278	289	301	312
		1000	102	108	115	123	131	140	155	166	177	188	199	222	233	246	257	269	280	292	304	316	328
		1100	107	113	119	128	137	153	165	176	188	200	212	234	247	260	272	286	298	311	323	336	348
		1200	109	116	123	133	148	161	174	187	199	212	224	248	262	274	288	301	315	328	341	354	368
		1300	112	119	127	141	155	168	181	194	208	222	234	258	272	287	300	314	328	342	356	370	383
		1400	114	124	131	148	163	176	191	205	218	233	247	271	286	301	315	330	345	360	374	389	404
210	210	1500	116	126	139	154	169	184	198	213	227	242	257	282	298	313	328	343	358	374	389	404	419
		1600	117	129	146	161	177	192	207	223	238	254	270	295	311	327	344	360	375	391	407	423	440
		1700	119	135	151	167	184	199	215	231	247	263	279	306	323	339	356	373	389	406	422	439	456
		1800	124	141	157	174	191	208	224	241	258	274	291	319	336	354	371	388	405	423	440	458	476
		1900	128	145	163	180	197	215	232	249	266	284	302	329	347	365	383	402	419	437	455	473	491
		2000	133	153	169	187	205	223	241	259	277	295	313	342	361	380	398	418	436	455	473	493	511
		2100	137	157	175	194	213	232	250	270	289	307	327	356	375	394	414	434	453	473	493	511	531
		2200	141	161	156	200	220	239	259	278	297	317	336	366	386	406	427	446	467	486	507	527	547
		2300	146	167	187	207	227	247	267	288	307	328	348	379	399	421	441	462	484	504	525	546	567
		2400	150	172	192	213	233	254	275	296	317	337	358	390	411	433	454	476	497	518	540	561	583
210	210	2500	154	176	198	220	242	263	284	305	328	349	370	403	424	447	470	492	514	536	558	580	
		2600	158	179	201	223	245	267	289	311	333	356	378	410	433	456	479	502	524	547	570		
		2700	161	184	206	229	253	275	298	321	344	366	390	423	447	471	494	517	541	565			
		2800	166	189	213	237	260	284	307	331	355	378	402	436	460	485	509	534	558				

Surcharge for guides		
PVC guide non-standard or woodlike colour (for 2 pcs.)	single-chamber PVC guide channel white colour (for 1 pcs.)	single-chamber PVC guide channel non-standard colour (for 1 pcs.)
5	2	4
6	3	4
8	3	5
9	4	6
10	4	7
11	5	7
12	5	8
13	6	9
14	6	9
15	7	10
16	7	11
17	8	12
18	8	12
19	9	13
20	9	14
22	10	15
23	10	15
24	10	16
25	11	17
26	11	17
27	12	18
28	12	19
29	13	20
30	13	20

Surcharges:	Winding pipe Ø40										Winding pipe Ø60																			
Non-standard revision flap	5	6	7	8	9	10	11	12	13	14	15	16	17	18	19	20	21	22	23	24	25									
Non-standard outer part	7	8	9	10	12	13	14	16	17	18	20	21	22	23	25	26	NO POSSIBILITY TO PRODUCE													
Non-standard internal part	7	8	9	10	12	13	14	16	17	18	20	21	22	23	25	26	NO POSSIBILITY TO PRODUCE													
Woodlike end slat	4	5	5	6	7	8	8	9	10	11	11	12	13	14	14	15	16	17	18	19	18	19								
Woodlike end slat RENOLIT	4	5	6	7	8	9	9	10	11	12	13	14	14	15	16	17	18	19	20	20	21									
Cover plate for ALU box from the outside	28	33	39	44	50	55	61	66	72	77	83	88	94	99	105	110	NO POSSIBILITY TO PRODUCE													
Steel strengthening the front and bottom profile	6	7	8	9	10	11	12	13	14	15	17	18	19	20	21	22	INCLUDED IN THE PRICE													
Block hangers	2 pieces / 18 €										3 pieces / 27 €										4 pieces / 36 €									

Standard equipment includes:

- white PVC box with insulation in sizes customized to the height of the roller shutter with angle irons for building in from the outside and from the inside.
- white revision flap in a bottom part of the box.
- a winding pipe (shaft) with a diameter of 40 or 60 mm, depending on the dimensions of the roller shutter.
- Pa 39 profile, perforated, standard colour
- manual control for tape - white box coiler, up to 12 kg.
- 56 mm end slat in standard colour with a rubber seal.
- white PVC guides.
- cable extraction outside in electric roller shutter on the side of the box.
- steel hangers.
- stopper.
- packing of box and guides with stretch wrap.

For an extra charge or optional (no information on order form means that the standard will be produce):

- white revision flap in a front part of the box (no surcharge) 0 € pcs.
- box coiler in brown or anthracite colour (no surcharge) 0 € pcs.
- tape in brown or anthracite colour (no surcharge) 0 € pcs.
- curtain profile without perforation (no surcharge) 0 € pcs.
- box without the angle irons for building in (no surcharge) 0 € pcs.
- bottom end caps of the guides 1 € set
- packing in corrugated cardboard 4 € rm
- packing in a 6 mm thick cardboard 15 € rm
- packing the box and the curtain profile separately 15 € rm
- winder crank for a tape up to 20 kg 30 € set
- end slat varnishing 15 € pcs.
- surcharge to curtain profile - woodlike colour 5 € m²
- surcharge to curtain profile - non-standard colour 8 € m²
- automatic lock (only roller shutters without motor) 30 € set
- spring 10 kg Ø 40 + cylinder lock 94 € set
- spring 15 kg Ø 40 + cylinder lock 106 € set
- spring 15 kg Ø 60 + cylinder lock 112 € set
- spring 24 kg Ø 60 + cylinder lock 115 € set
- steel reinforcement console (no possibility to install in 170 Box) 33 € pcs.
- mounting anchor for connecting the box with the headroom 1,25 € pcs.
- Neopor insulation 7 € rm
- oval or rectangular cover plates on the sides of the boxes 9,50 € set
- frontal box profile oval from the inside 4 € rm
- drive selected according to legend, drives prices on pages 50 - 57.
- remote control with the appropriate number of channels, prices on pages 50 - 57.
- push-button switch selectable on pages 50 - 57

Specification

- 10 Nm short Ø 40 motor
- 10 Nm Ø 40 motor
- 13 Nm Ø 40 motor
- 13 Nm Ø 60 motor
- 23 Nm Ø 60 motor



Price list for Opoterm roller shutters in woodlike colour, PA39 profile

Net prices in EUR

Box with Ø60 pipe	Box with Ø40 pipe	Width Height	500	600	700	800	900	1000	1100	1200	1300	1400	1500	1600	1700	1800	1900	2000	2100	2200	2300	2400	2500	
170	170	500	89	97	105	112	119	127	133	140	148	155	161	167	190	200	209	219	228	237	247	257	266	
		600	94	102	110	118	126	133	140	148	156	163	171	189	206	217	226	237	247	257	267	278	288	
		700	100	107	115	123	131	140	147	156	164	172	189	211	222	233	245	255	266	277	288	300	311	
		800	102	111	119	128	136	145	153	161	179	190	201	223	235	247	259	270	282	293	305	317	329	
		900	107	116	124	133	142	151	159	180	192	204	215	238	250	263	275	288	301	313	326	338	351	
		1000	109	119	129	138	147	156	176	189	202	214	227	250	263	277	290	303	316	329	343	356	369	
		1100	115	124	134	144	154	174	188	201	215	228	242	265	280	293	307	322	336	349	364	378	392	
		1200	119	129	139	149	171	185	198	213	227	242	256	280	295	310	325	340	355	370	386	402	418	432
		1300	122	132	143	163	178	193	208	223	237	252	267	292	308	324	340	355	370	386	406	422	438	455
		1400	127	137	148	172	187	203	218	234	250	265	281	307	324	340	357	373	389	405	422	439	456	473
		1500	131	141	163	179	195	211	228	244	260	277	292	320	337	354	371	389	405	422	439	456	473	
		1600	136	146	170	187	205	222	239	256	273	290	307	336	353	371	389	406	424	443	460	478	496	
		1700	141	159	176	194	212	230	248	265	283	301	319	348	366	385	403	421	440	459	477	496	514	
		1800	147	165	184	202	221	239	259	277	296	314	332	363	381	401	420	440	459	479	497	517	536	
210	210	1900	152	171	190	209	229	248	267	287	306	325	345	375	395	415	435	455	475	495	514	535	554	
		2000	157	177	197	217	238	258	278	298	319	339	359	389	411	431	452	473	494	514	535	556	577	
		2100	164	185	205	226	247	268	289	310	331	352	373	405	427	448	470	492	513	535	556	578	600	
		2200	168	190	212	233	255	277	298	320	341	363	385	418	439	462	484	506	529	551	573	595	618	
		2300	174	197	220	242	264	287	309	331	354	377	399	432	455	478	501	524	548	571	594	617	640	
		2400	180	202	225	249	272	295	318	341	364	387	411	444	468	492	516	539	563	587	611	635	659	
		2500	185	209	233	257	281	305	329	353	377	401	424	459	484	509	534	558	582	607	631	656		
		2600	187	212	237	261	286	310	335	360	384	409	433	469	494	519	545	570	595	621	646			
		2700	193	218	244	270	295	320	346	371	397	422	447	484	510	536	562	588	614	640				
		2800	199	225	251	278	304	330	356	382	409	435	461	498	525	552	579	606	633					

Surcharge for guides	
single-chamber	
PVC guide	
woodlike colour	
(for 1 pcs.)	
16	
19	
22	
25	
28	
31	
34	
38	
41	
44	
47	
50	
53	
56	
59	
63	
66	
69	
72	
75	
78	
81	
84	
88	

Surcharges:	Winding pipe Ø40 ←										→ Winding pipe Ø60										
Non-standard revision flap	5	6	7	8	9	10	11	12	13	14	15	16	17	18	19	20	21	22	23	24	25
Non-standard outer part	7	8	9	10	12	13	14	16	17	18	20	21	22	23	25	26	NO POSSIBILITY TO PRODUCE				
Non-standard internal part	7	8	9	10	12	13	14	16	17	18	20	21	22	23	25	26	NO POSSIBILITY TO PRODUCE				
Woodlike end slat RENOLIT	1	1	1	1	1	2	2	2	2	2	2	2	3	3	3	3	3	3	3	4	4
Cover plate for ALU box from the outside	28	33	39	44	50	55	61	66	72	77	83	88	94	99	105	110	NO POSSIBILITY TO PRODUCE				
Steel strengthening the front and bottom profile	6	7	8	9	10	11	12	13	14	15	17	18	19	20	21	22	INCLUDED IN THE PRICE				
Block hangers	2 pieces / 18 €					3 pieces / 27 €					4 pieces / 36 €										

Standard equipment includes:

- white PVC box with insulation in sizes customized to the height of the roller shutter with angle irons for building in from the outside and from the inside.
- white revision flap in a bottom part of the box.
- a winding pipe (shaft) with a diameter of 40 or 60 mm, depending on the dimensions of the roller shutter.
- profile Pa 39 perforated, woodlike colour.
- manual control for tape - white box coiler, up to 12 kg.
- 56 mm end slat varnished in woodlike colour with a rubber seal.
- PVC woodlike or non-standard colour guides.
- cable extraction outside in electric roller shutter on the side of the box.
- steel hangers.
- stopper.
- packing of box and guides with stretch wrap.

For an extra charge or optional (no information on order form means that the standard will be produce):

- white revision flap in a front part of the box (no surcharge) 0 € pcs.
- white revision flap in a front part of the box (no surcharge) 0 € pcs.
- box coiler in brown or anthracite colour (no surcharge) 0 € pcs.
- tape in brown or anthracite colour (no surcharge) 0 € pcs.
- curtain profile without perforation (no surcharge) 0 € pcs.
- box without the angle irons for building in (no surcharge) 0 € pcs.
- bottom end caps of the guides 1 € set
- packing in corrugated cardboard 4 € rm
- packing in a 6 mm thick cardboard 15€ rm
- packing the box and the curtain profile separately 15 € rm
- winder crank for a tape up to 20 kg 30 € set
- automatic lock (only roller shutters without motor) 30 € set
- spring 10 kg Ø 40 + cylinder lock 94 € set

- spring 15 kg Ø 40 + cylinder lock 106 € set
- spring 15 kg Ø 60 + cylinder lock 112 € set
- spring 24 kg Ø 60 + cylinder lock 115 € set
- steel reinforcement console (no possibility to install in 170 Box) 33 € pcs.
- mounting anchor for connecting the box with the headroom 1,25 € pcs.
- Neopor insulation 7 € rm
- oval or rectangular cover plates on the sides of the boxes 9,50 € set
- frontal box profile oval from the inside 4 € rm
- drive selected according to legend, drives prices on pages 50 - 57.
- remote control with the appropriate number of channels, prices on pages 50 - 57.
- push-button switch selectable on pages 50 - 57

Specification

- 10 Nm short Ø 40 motor
- 10 Nm Ø 40 motor
- 13 Nm Ø 40 motor
- 13 Nm Ø 60 motor
- 23 Nm Ø 60 motor

Price list for Opoterm roller shutters in non-standard colour, PA39 profile

Net prices in EUR

Box with Ø60 pipe	Box with Ø40 pipe	Width Height	Winding pipe Ø40																					
			500	600	700	800	900	1000	1100	1200	1300	1400	1500	1600	1700	1800	1900	2000	2100	2200	2300	2400	2500	
170	170	500	114	123	133	142	151	160	169	178	188	196	204	212	242	254	265	278	290	301	313	326	337	
		600	120	130	140	149	159	169	178	188	198	207	217	240	262	275	288	301	314	327	339	353	366	
		700	127	137	146	157	167	177	187	198	208	218	241	268	282	296	310	324	337	352	366	380	394	
		800	129	140	151	162	173	184	194	205	228	242	256	283	298	313	329	343	358	373	387	402	418	
		900	136	147	158	169	180	191	202	228	244	259	274	302	318	334	350	366	382	398	414	430	446	
		1000	138	151	164	175	187	198	224	241	256	272	289	318	335	352	368	385	402	419	435	452	469	
		1100	146	158	170	183	196	222	239	256	272	290	307	337	355	373	390	409	427	444	462	480	498	
		1200	151	164	177	189	217	234	252	271	289	307	325	356	375	394	413	432	451	470	490	510	530	549
		1300	156	168	181	207	226	245	264	283	302	320	339	371	392	411	431	451	470	490	510	530	549	
		1400	162	174	188	218	238	258	277	297	317	337	357	390	412	432	453	473	494	515	536	557	578	
		1500	167	179	206	227	248	268	289	310	331	352	371	406	428	450	471	493	514	536	557	579	601	
		1600	173	185	217	238	260	281	303	325	347	368	390	426	449	471	493	516	538	562	584	607	630	
		1700	179	201	223	247	269	292	315	337	360	382	405	441	464	488	512	535	559	583	606	629	653	
		210	210	1800	186	210	233	257	281	304	329	352	376	399	422	461	484	510	534	558	583	608	632	657
1900	192			217	241	266	290	315	339	364	388	413	438	476	502	527	552	578	602	628	653	679	704	
2000	199			225	250	276	302	328	353	379	404	430	456	494	521	548	575	600	627	653	680	706	733	
2100	208			234	261	287	314	341	367	394	420	447	474	514	542	568	597	625	652	679	706	734	762	
2200	213			241	269	296	323	352	379	406	434	461	489	530	558	586	615	643	671	700	728	756	784	
2300	220			250	279	307	335	364	392	421	450	478	506	549	578	607	637	666	695	725	754	783	813	
2400	228			257	286	316	345	375	404	433	462	492	521	564	595	625	654	685	716	746	776	806	837	
2500	235			265	296	326	356	387	418	448	479	509	538	583	615	646	678	708	739	771	801	833		
2600	238			269	301	332	363	394	426	457	488	519	550	595	627	659	692	723	755	788	820			
2700	245			277	310	342	375	406	439	471	504	536	568	614	647	680	713	747	780	813				
2800	252	286	318	353	386	419	452	485	519	553	586	633	667	701	736	770	804							

Surcharge for guides	
aluminum guide varnished in RAL colour (for 2 pcs.)	
16	
19	
22	
25	
28	
31	
34	
38	
41	
44	
47	
50	
53	
56	
59	
63	
66	
69	
72	
75	
78	
81	
84	
88	

Surcharges:	Winding pipe Ø40										Winding pipe Ø60																				
Non-standard revision flap	5	6	7	8	9	10	11	12	13	14	15	16	17	18	19	20	21	22	23	24	25	NO POSSIBILITY TO PRODUCE									
Non-standard outer part	7	8	9	10	12	13	14	16	17	18	20	21	22	23	25	26	NO POSSIBILITY TO PRODUCE														
Non-standard internal part	7	8	9	10	12	13	14	16	17	18	20	21	22	23	25	26	NO POSSIBILITY TO PRODUCE														
Woodlike end slat RENOLIT	1	1	1	1	1	2	2	2	2	2	2	2	3	3	3	3	3	3	3	4	4	NO POSSIBILITY TO PRODUCE									
Cover plate for ALU box from the outside	28	33	39	44	50	55	61	66	72	77	83	88	94	99	105	110	INCLUDED IN THE PRICE														
Steel strengthening the front and bottom profile	6	7	8	9	10	11	12	13	14	15	17	18	19	20	21	22	INCLUDED IN THE PRICE														
Block hangers	2 pieces / 18 €										3 pieces / 27 €										4 pieces / 36 €										

Standard equipment includes:

- white PVC box with insulation in sizes customized to the height of the roller shutter with angle irons for building in from the outside and from the inside.
- white revision flap in a bottom part of the box.
- a winding pipe (shaft) with a diameter of 40 or 60 mm, depending on the dimensions of the roller shutter.
- Pa 39 profile, perforated, non-standard colour.
- manual control for tape - white box coiler, up to 12 kg.
- 56mm high end slat in non-standard colour with a rubber seal.
- PVC woodlike or non-standard colour guides.
- cable extraction outside in electric roller shutter on the side of the box.
- steel hangers.
- stopper.
- packing of box and guides with stretch wrap.

For an extra charge or optional (no information on order form means that the standard will be produce):

- white revision flap in a front part of the box (no surcharge) 0 € pcs.
- white revision flap in a front part of the box (no surcharge) 0 € pcs.
- box coiler in brown or anthracite colour (no surcharge) 0 € pcs.
- tape in brown or anthracite colour (no surcharge) 0 € pcs.
- curtain profile without perforation (no surcharge) 0 € pcs.
- box without the angle irons for building in (no surcharge) 0 € pcs.
- bottom end caps of the guides 1 € set
- packing in corrugated cardboard 4 € rm
- packing in a 6 mm thick cardboard 15 € rm
- packing the box and the curtain profile separately 15 € rm
- winder crank for a tape up to 20 kg 30 € set
- automatic lock (only roller shutters without motor) 30 € set
- spring 10 kg Ø 40 + cylinder lock 94 € set
- spring 15 kg Ø 40 + cylinder lock 106 € set
- spring 15 kg Ø 60 + cylinder lock 112 € set
- spring 24 kg Ø 60 + cylinder lock 115 € set
- steel reinforcement console (no possibility to install in 170 Box) 33 € pcs.
- mounting anchor for connecting the box with the headroom 1,25 € pcs.
- Neopor insulation 7 € rm
- oval or rectangular cover plates on the sides of the boxes 9,50 € set
- frontal box profile oval from the inside 4 € rm
- drive selected according to legend, drives prices on pages 50 - 57.
- remote control with the appropriate number of channels, prices on pages 50 - 57.
- push-button switch selectable on pages 50 - 57

Specification

- 10 Nm short Ø 40 motor
- 10 Nm Ø 40 motor
- 13 Nm Ø 40 motor
- 13 Nm Ø 60 motor
- 23 Nm Ø 60 motor

- PVC box, insulated.
- 60 mm wide PVC guides or ALU for an extra charge.
- 43 mm aluminum profile filled with polyurethane foam (weight 2,6 kg/m³).
- maximum dimensions of roller shutters or roller shutters sets:
 - single roller shutter, without reinforcements, box for building in or white: width 2000 mm, height 3800 mm.
 - single roller shutter, with reinforcements, box for building in or white: width 2500 mm, height 3800 mm.
 - set with reinforcements, console, box for building in or white: width 3200 mm, height 3800 mm.
 - single roller shutter, without reinforcements, box other than white: width 1600 mm, height 3800 mm.
 - single roller shutter, with reinforcements, box other than white: width 2000 mm, height 3800 mm.
 - set with reinforcements, console, box other than white: width 2500 mm, height 3800 mm.
- (for 1 class wind resistance according to EN13659).
- manual drive in the form of a box coiler for tape (maximum curtain profile weight: up to 12 kg).
- maximum roller shutter surface 9 m².
- recommended by the system provider stability for the curtain is obtained for surface up to 7 m². Above this value slight undulations of the curtain may occur - however, this does not affect functionality and roller shutter fulfills all criteria specified by the norm.

43 mm „PA-43“ aluminum profile.

“PPD-60/12” guide.

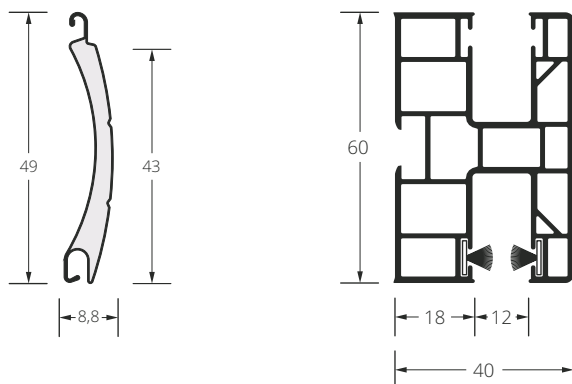

* RAL numbers mean the colours similar to real, the most reliable way to verify is our colour sampler.

- 1. – longer realization term.
- 2. – painting surcharge, longer realization term.
- 4. – minimum order is 15 m².

Colour	symbol	RAL*	Curtain profile	End slat	PVC Guide	Box	Revision flap	single chamber guide	oval lateral profile of box	lateral cover plate of box (PVC)	oval lateral cover plate of box (PVC)
standard colours											
silver	01	9006	✓	✓							
white	02	9016	✓	✓	✓	✓	✓	1	✓	✓	✓
grey	03	7038	✓	✓							
dark beige	04	1019	4								
beige	05	1013	✓	✓							
dark brown	08	8019	✓	✓						1	1
brown	09	8014	✓	✓							
crème white	15	9001	✓	1							
ivory	16	1015	✓	2							
ultra white	22		1	1							
anthracite grey	23	7016	✓	✓						1	1
light grey	31	7047	✓	1							
woodlike (surcharge)											
dark wood	06		4								
mahogany	26		✓								
walnut	28		✓	✓							
golden oak	30		✓	✓							
swamp oak	36		✓								
winchester	52		✓								
woodlike, foil, renolite (surcharge)											
anthracite	23R	701605		1	1	1	1	1			
anthracite smooth	25R	701605-083		✓	1						
mahogany	26R	2065021		✓	1	1	1				
walnut	28R	2178007		✓	1	1	1	1			
golden oak	30R	2178001		✓	1	1	1	1			
light grey	31R	725105			1						
basalt grey	33R	701205			1						
winchester	52R	49240		✓	1	1	1				
dark oak	53R	2052089		✓	1	1	1				
palisander	54R	851805			1						
chocolate brown	55R	887505			1						
grey	57R	715505			1						
swamp oak	58R	3167004			1						
crème white	66R	137905			1						
dark green	67R	612505			1						
non-standard (surcharge)											
black	20	9005		1	2						
basalt grey	33	7012		✓	2						
quartz grey	34	7039		✓	✓						
concrete grey	35	7023		4	2						
grey aluminum	37	9007		1	2						



OPOTERM

Price list for Opoterm roller shutters in standard colour, PA43 profile

		Net prices in EUR																							
Box with Ø60 pipe	Box with Ø40 pipe	Width Height	500	600	700	800	900	1000	1100	1200	1300	1400	1500	1600	1700	1800	1900	2000	2100	2200	2300	2400	2500		
			170	170	500	93	97	101	108	115	122	129	135	143	150	152	167	182	190	199	209	218	227	236	246
600	96	101			106	114	121	129	136	144	152	159	167	185	198	208	217	227	237	247	257	268	278		
700	99	106			111	119	128	135	144	152	160	168	182	203	214	224	235	246	257	268	279	289	288		
800	102	109			115	124	132	141	150	158	172	183	194	215	227	239	251	262	273	285	297	308	320		
900	107	114			120	130	139	148	157	173	185	196	209	231	243	255	268	281	293	305	318	330	343		
1000	109	117			125	134	144	153	170	183	195	208	220	244	256	270	283	297	309	322	336	349	362		
1100	114	122			130	140	151	168	182	194	208	221	235	259	273	287	301	316	329	344	358	373	386		
1200	118	127			135	146	163	177	192	207	221	235	249	274	290	304	319	333	349	364	379	394	409		
1300	120	130			139	156	171	186	201	216	231	246	261	287	303	319	334	350	366	381	397	413	428		
1400	123	135			144	164	179	195	212	227	243	260	275	303	319	335	352	368	385	402	418	435	452		
1500	126	138	154	171	188	204	221	237	254	271	288	315	332	350	367	385	401	419	436	454	471				
210	210	1600	129	142	161	179	197	214	231	249	267	285	303	330	349	367	385	403	422	440	458	476	495		
		1700	131	149	168	186	204	223	241	259	278	296	314	343	362	381	400	419	438	457	476	495	514		
		1800	136	156	174	194	213	233	251	270	290	309	328	358	378	398	418	438	457	477	497	517	537		
		1900	141	161	181	201	221	241	261	280	300	320	341	371	391	412	433	454	474	494	515	536	556		
		2000	146	170	188	209	230	250	271	292	313	334	355	386	408	430	451	472	494	515	537	558	579		
		2100	151	174	196	217	239	261	282	305	326	347	369	402	424	446	469	492	514	536	559	580	603		
		2200	156	179	177	224	247	269	292	314	337	359	382	415	438	461	484	507	530	553	576	599	623		
		2300	161	186	209	233	255	279	302	325	349	373	396	430	453	477	501	526	550	574	598	622	646		
		2400	166	191	215	239	263	287	311	336	359	384	407	443	467	492	517	541	566	591	616	640	665		
		2500	170	197	222	247	272	297	322	346	373	397	422	458	483	509	535	561	586	612	637	662	687		
2600	175	200	225	251	278	303	328	354	379	405	431	467	494	520	547	573	599	626	652	678	704				
2700	180	206	233	259	286	312	339	366	392	418	446	482	510	537	565	591	619	646	674	701	729				
2800	185	212	240	268	295	322	349	377	405	432	460	497	526	554	582	611	639	668	695	724	752				

Surcharge for guides		
PVC guide non-standard or woodlike colour (for 2 pcs.)	single-chamber PVC guide channel white colour (for 1 pcs.)	single-chamber PVC guide channel non-standard colour (for 1 pcs.)
5	2	4
6	3	4
8	3	5
9	4	6
10	4	7
11	5	7
12	5	8
13	6	9
14	6	9
15	7	10
16	7	11
17	8	12
18	8	12
19	9	13
20	9	14
22	10	15
23	10	15
24	10	16
25	11	17
26	11	17
27	12	18
28	12	19
29	13	20
30	13	20

Surcharges:	Winding pipe Ø40 ← → Winding pipe Ø60																									
Non-standard revision flap	5	6	7	8	9	10	11	12	13	14	15	16	17	18	19	20	21	22	23	24	25					
Non-standard outer part	7	8	9	10	12	13	14	16	17	18	20	21	22	23	25	26	NO POSSIBILITY TO PRODUCE									
Non-standard internal part	7	8	9	10	12	13	14	16	17	18	20	21	22	23	25	26	NO POSSIBILITY TO PRODUCE									
Woodlike end slat	4	5	5	6	7	8	8	9	10	11	11	12	13	14	14	15	16	17	17	18	19					
Woodlike end slat RENOLIT	4	5	6	7	8	9	9	10	11	12	13	14	14	15	16	17	18	19	20	20	21					
Cover plate for ALU box from the outside	28	33	39	44	50	55	61	66	72	77	83	88	94	99	105	110	NO POSSIBILITY TO PRODUCE									
Steel strengthening the front and bottom profile	6	7	8	9	10	11	12	13	14	15	17	18	19	20	21	22	INCLUDED IN THE PRICE									
Block hangers	2 pieces / 18 €							3 pieces / 27 €							4 pieces / 36 €											

Specification	
- 10 Nm short Ø 40 motor	
- 10 Nm Ø 40 motor	
- 13 Nm Ø 40 motor	
- 13 Nm Ø 60 motor	
- 23 Nm Ø 60 motor	

Standard equipment includes:

- white PVC box with insulation in sizes customized to the height of the roller shutter with angle irons for building in from the outside and from the inside.
- white revision flap in a bottom part of the box.
- a winding pipe (shaft) with a diameter of 40 or 60 mm, depending on the dimensions of the roller shutter.
- Pa 43 profile, perforated, standard colour
- manual control for tape - white box coiler, up to 12 kg.
- 56 mm end slat in standard colour with a rubber seal.
- white PVC guides.
- steel strengthening the front and bottom profile in roller shutters over 2500 mm wide
- cable extraction outside in electric roller shutter on the side of the box.
- steel hangers.
- stopper.
- packing of box and guides with stretch wrap.

For an extra charge or optional (no information on order form means that the standard will be produce):

- white revision flap in a front part of the box (no surcharge) 0 € pcs.
- box coiler in brown or anthracite colour (no surcharge) 0 € pcs.
- tape in brown or anthracite colour (no surcharge) 0 € pcs.
- curtain profile without perforation (no surcharge) 0 € pcs.
- box without the angle irons for building in (no surcharge) 0 € pcs.
- bottom end caps of the guides 1 € set
- packing in corrugated cardboard 4 € rm
- packing in a 6 mm thick cardboard 15 € rm
- packing the box and the curtain profile separately 15 € rm
- winder crank for a tape up to 20 kg 30 € set
- end slat varnishing 15 € pcs.
- surcharge to curtain profile - woodlike colour 5 € m²
- surcharge to curtain profile - non-standard colour 8 € m²
- automatic lock (only roller shutters without motor) 30 € set
- spring 10 kg Ø 40 + cylinder lock 94 € set
- spring 15 kg Ø 40 + cylinder lock 106 € set
- spring 15 kg Ø 60 + cylinder lock 112 € set
- spring 24 kg Ø 60 + cylinder lock 115 € set
- steel reinforcement console (no possibility to install in 170 Box) 33 € pcs.
- mounting anchor for connecting the box with the headroom 1,25 € pcs.
- Neopor insulation 7 € rm
- oval or rectangular cover plates on the sides of the boxes 9,50 € set
- frontal box profile oval from the inside 4 € rm
- drive selected according to legend, drives prices on pages 50 - 57.
- remote control with the appropriate number of channels, prices on pages 50 - 57.
- push-button switch selectable on pages 50 - 57

Price list for Opoterm roller shutters in woodlike colour, PA43 profile

Net prices in EUR

Box with Ø60 pipe	Box with Ø40 pipe	Width Height	Width																				
			500	600	700	800	900	1000	1100	1200	1300	1400	1500	1600	1700	1800	1900	2000	2100	2200	2300	2400	2500
170	170	500	93	101	110	117	125	133	141	149	156	164	171	178	202	212	222	233	243	252	262	273	283
		600	98	107	116	124	132	141	150	157	167	174	183	202	221	231	242	253	264	275	286	298	309
		700	104	113	122	131	140	149	158	167	176	185	204	226	238	250	263	274	286	298	310	322	335
		800	107	117	127	136	146	156	165	175	193	206	217	241	253	267	280	292	304	318	330	343	356
		900	113	123	133	143	153	163	173	194	208	221	234	258	271	285	299	313	327	341	354	368	382
		1000	116	127	138	149	159	170	192	206	220	233	248	272	287	302	316	331	345	360	375	389	403
		1100	122	133	144	156	168	190	205	220	234	249	264	289	305	321	336	352	368	383	399	414	430
		1200	127	139	151	163	186	201	217	233	249	264	281	307	323	340	356	373	389	406	422	439	456
		1300	131	143	155	177	194	211	227	244	261	278	293	321	339	356	374	390	408	425	443	460	477
		1400	136	149	161	187	204	222	239	257	274	292	310	338	357	375	393	411	430	448	466	484	503
210	210	1500	142	153	177	195	214	232	250	269	287	306	323	353	373	391	410	430	448	467	486	505	524
		1600	147	159	186	205	225	244	263	282	302	321	340	370	390	411	430	451	471	491	510	531	551
		1700	153	173	192	213	233	253	273	293	314	333	354	385	405	426	447	468	489	510	531	552	572
		1800	159	180	201	222	243	264	286	307	328	349	369	402	423	446	467	489	511	533	554	576	598
		1900	165	186	208	230	252	274	295	318	340	362	384	416	439	461	484	507	529	552	574	598	620
		2000	170	193	216	240	263	286	308	331	354	377	400	434	457	481	505	528	551	575	599	622	646
		2100	178	202	226	249	273	298	321	345	368	393	416	451	476	500	525	550	574	598	623	647	672
		2200	184	208	233	257	282	307	331	356	381	405	430	465	491	516	541	567	592	617	643	668	693
		2300	189	216	242	267	292	319	344	369	395	421	446	482	509	535	561	588	614	640	666	693	719
		2400	196	222	248	275	302	328	354	381	407	434	460	497	524	551	578	605	632	660	687	713	741
2500	202	229	257	284	311	339	366	394	422	449	476	514	542	570	599	627	654	683	710	739	767		
2600	205	233	262	290	318	346	375	402	431	459	486	526	555	583	613	641	670	699	728	756	785		
2700	212	241	270	299	328	357	386	415	444	474	503	543	573	603	633	662	692	722	752	782	813		
2800	218	248	278	308	339	368	399	428	459	489	519	559	591	621	652	683	714	745	776	807	838		

Surcharge for guides	
single-chamber	16
PVC guide	19
woodlike colour	22
(for 1 pcs.)	25
	28
	31
	34
	38
	41
	44
	47
	50
	53
	56
	59
	63
	66
	69
	72
	75
	78
	81
	84
	88

Surcharges:	Winding pipe Ø40										Winding pipe Ø60										
	5	6	7	8	9	10	11	12	13	14	15	16	17	18	19	20	21	22	23	24	25
Non-standard revision flap	5	6	7	8	9	10	11	12	13	14	15	16	17	18	19	20	21	22	23	24	25
Non-standard outer part	7	8	9	10	12	13	14	16	17	18	20	21	22	23	25	26	NO POSSIBILITY TO PRODUCE				
Non-standard internal part	7	8	9	10	12	13	14	16	17	18	20	21	22	23	25	26	NO POSSIBILITY TO PRODUCE				
Woodlike end slat RENOLIT	1	1	1	1	1	2	2	2	2	2	2	2	3	3	3	3	3	3	3	4	4
Cover plate for ALU box from the outside	28	33	39	44	50	55	61	66	72	77	83	88	94	99	105	110	NO POSSIBILITY TO PRODUCE				
Steel strengthening the front and bottom profile	6	7	8	9	10	11	12	13	14	15	17	18	19	20	21	22	INCLUDED IN THE PRICE				
Block hangers	2 pieces / 18 €					3 pieces / 27 €					4 pieces / 36 €										

Standard equipment includes:

- white PVC box with insulation in sizes customized to the height of the roller shutter with angle irons for building in from the outside and from the inside.
- white revision flap in a bottom part of the box.
- a winding pipe (shaft) with a diameter of 40 or 60 mm, depending on the dimensions of the roller shutter.
- profile Pa 43 perforated, woodlike colour
- manual control for tape - white box coiler, up to 12 kg.
- 56 mm end slat varnished in woodlike colour with a rubber seal.
- PVC woodlike or non-standard colour guides.
- cable extraction outside in electric roller shutter on the side of the box.
- steel hangers.
- stopper.
- packing of box and guides with stretch wrap.

For an extra charge or optional (no information on order form means that the standard will be produce):

- white revision flap in a front part of the box (no surcharge) 0 € pcs.
- box coiler in brown or anthracite colour (no surcharge) 0 € pcs.
- tape in brown or anthracite colour (no surcharge) 0 € pcs.
- curtain profile without perforation (no surcharge) 0 € pcs.
- box without the angle irons for building in (no surcharge) 0 € pcs.
- bottom end caps of the guides 1 € set
- packing in corrugated cardboard 4 € rm
- packing in a 6 mm thick cardboard 15 € rm
- packing the box and the curtain profile separately 15 € rm
- winder crank for a tape up to 20 kg 30 € set
- automatic lock (only roller shutters without motor) 30 € set
- spring 10 kg Ø 40 + cylinder lock 94 € set
- spring 15 kg Ø 40 + cylinder lock 106 € set
- spring 15 kg Ø 60 + cylinder lock 112 € set
- spring 24 kg Ø 60 + cylinder lock 115 € set
- steel reinforcement console (no possibility to install in 170 Box) 33 € pcs.
- mounting anchor for connecting the box with the headroom 1,25 € pcs.
- Neopor insulation 7 € rm
- oval or rectangular cover plates on the sides of the boxes 9,50 € set
- frontal box profile oval from the inside 4 € rm
- drive selected according to legend, drives prices on pages 50 - 57.
- remote control with the appropriate number of channels, prices on pages 50 - 57.
- push-button switch selectable on pages 50 - 57

Specification

- 10 Nm short Ø 40 motor
- 10 Nm Ø 40 motor
- 13 Nm Ø 40 motor
- 13 Nm Ø 60 motor
- 23 Nm Ø 60 motor



Net prices in EUR

Box with Ø60 pipe	Box with Ø40 pipe	Width Height	Width																				
			500	600	700	800	900	1000	1100	1200	1300	1400	1500	1600	1700	1800	1900	2000	2100	2200	2300	2400	2500
170	170	500	116	126	138	146	156	167	176	186	196	205	214	223	253	265	278	291	303	315	328	342	354
		600	123	134	144	155	166	176	187	197	208	218	229	253	275	289	303	317	330	344	358	373	386
		700	131	141	153	164	175	187	198	209	220	232	255	283	298	312	329	342	357	373	388	403	419
		800	134	146	158	170	183	194	207	219	242	257	272	301	317	333	350	365	380	397	413	428	446
		900	141	153	166	179	191	203	217	243	260	276	292	322	339	356	374	391	408	426	443	460	478
		1000	144	159	173	186	199	212	239	257	275	292	310	340	358	377	395	413	432	450	468	486	504
		1100	153	167	181	194	210	237	256	275	292	311	330	362	381	401	420	440	459	479	498	518	537
		1200	159	174	189	203	232	251	271	291	311	330	351	383	404	425	446	466	487	507	528	549	569
		1300	164	179	194	221	243	263	284	305	326	347	367	401	424	445	467	488	509	531	554	575	596
		1400	170	186	202	234	256	278	299	321	343	365	387	423	446	469	492	514	538	560	582	605	628
1500	178	191	221	244	267	290	312	336	359	382	404	441	465	488	512	538	560	584	607	632	656		
210	210	1600	184	199	232	256	281	305	329	353	377	401	425	463	488	513	538	563	588	614	638	663	689
		1700	191	216	240	266	291	317	342	366	392	417	443	482	507	533	559	585	612	638	663	690	716
		1800	198	225	251	278	304	330	357	384	410	436	462	503	529	557	584	612	639	667	693	720	748
		1900	206	233	260	288	315	342	369	398	425	452	480	520	549	577	605	634	662	690	718	747	774
		2000	213	242	270	300	329	357	385	414	443	472	500	542	571	601	631	660	689	718	748	778	807
		2100	222	252	282	311	342	372	401	432	460	491	520	564	595	625	657	687	717	748	778	809	840
		2200	229	260	291	321	352	384	414	446	476	507	538	582	614	645	676	708	740	771	803	835	866
		2300	237	270	302	333	365	398	429	461	494	526	557	603	636	669	701	735	767	801	833	866	899
		2400	245	278	310	343	377	410	443	476	509	542	575	621	655	689	722	757	790	825	859	892	927
		2500	253	287	321	356	389	424	458	493	527	562	595	643	678	713	748	783	818	853	887	923	958
2600	256	292	327	362	398	433	468	503	539	574	608	658	693	729	766	802	837	874	910	946	981		
2700	264	301	337	374	410	446	483	519	555	592	628	679	716	753	791	828	865	903	940	978	1016		
2800	272	310	347	386	423	460	498	535	574	612	648	699	738	777	815	854	892	931	970	1008	1047		

Winding pipe Ø40 ←

→ Winding pipe Ø60

Surcharges:																					
Non-standard revision flap	5	6	7	8	9	10	11	12	13	14	15	16	17	18	19	20	21	22	23	24	25
Non-standard outer part	7	8	9	10	12	13	14	16	17	18	20	21	22	23	25	26	NO POSSIBILITY TO PRODUCE				
Non-standard internal part	7	8	9	10	12	13	14	16	17	18	20	21	22	23	25	26	NO POSSIBILITY TO PRODUCE				
Woodlike end slat RENOLIT	1	1	1	1	1	2	2	2	2	2	2	3	3	3	3	3	3	3	3	4	4
Cover plate for ALU box from the outside	28	33	39	44	50	55	61	66	72	77	83	88	94	99	105	110	NO POSSIBILITY TO PRODUCE				
Steel strengthening the front and bottom profile	6	7	8	9	10	11	12	13	14	15	17	18	19	20	21	22	INCLUDED IN THE PRICE				
Block hangers	2 pieces / 18 €							3 pieces / 27 €							4 pieces / 36 €						

Specification

- 10 Nm short Ø 40 motor
- 10 Nm Ø 40 motor
- 13 Nm Ø 40 motor
- 13 Nm Ø 60 motor
- 23 Nm Ø 60 motor

Standard equipment includes:

- white PVC box with insulation in sizes customized to the height of the roller shutter with angle irons for building in from the outside and from the inside.
- white revision flap in a bottom part of the box.
- a winding pipe (shaft) with a diameter of 40 or 60 mm, depending on the dimensions of the roller shutter.
- Pa 43 profile, perforated, non-standard colour.
- manual control for tape - white box coiler, up to 12 kg.
- 56 mm high end slat in non-standard colour with a rubber seal.
- PVC woodlike or non-standard colour guides.
- cable extraction outside in electric roller shutter on the side of the box.
- steel hangers.
- stopper.
- packing of box and guides with stretch wrap.

For an extra charge or optional (no information on order form means that the standard will be produce):

- white revision flap in a front part of the box (no surcharge) 0 € pcs.
- box coiler in brown or anthracite colour (no surcharge) 0 € pcs.
- tape in brown or anthracite colour (no surcharge) 0 € pcs.
- curtain profile without perforation (no surcharge) 0 € pcs.
- box without the angle irons for building in (no surcharge) 0 € pcs.
- bottom end caps of the guides 1 € set
- packing in corrugated cardboard 4 € rm
- packing in a 6 mm thick cardboard 15 € rm
- packing the box and the curtain profile separately 15 € rm
- winder crank for a tape up to 20 kg 30 € set
- automatic lock (only roller shutters without motor) 30 € set
- spring 10 kg Ø 40 + cylinder lock 94 € set
- spring 15 kg Ø 40 + cylinder lock 106 € set
- spring 15 kg Ø 60 + cylinder lock 112 € set
- spring 24 kg Ø 60 + cylinder lock 115 € set
- steel reinforcement console (no possibility to install in 170 Box) 33 € pcs.
- mounting anchor for connecting the box with the headroom 1,25 € pcs.
- Neopor insulation 7 € rm
- oval or rectangular cover plates on the sides of the boxes 9,50 € set
- frontal box profile oval from the inside 4 € rm
- drive selected according to legend, drives prices on pages 50 - 57.
- remote control with the appropriate number of channels, prices on pages 50 - 57.
- push-button switch selectable on pages 50 - 57

- PVC box, insulated.
- 60 mm wide PVC guides or ALU for an extra charge.
- 39 mm aluminum profile filled with polyurethane foam (weight 2,8 kg/m³).
- maximum dimensions: width 2700 mm, height 2800 mm (for 1 class wind resistance according to EN13659).
- manual drive in the form of a box coiler for tape (maximum armour-plate weight: up to 12 kg).
- maximum roller shutter surface 6 m².



REVO

39 mm „PA-39“ aluminum profile.

“PG-60” guide.

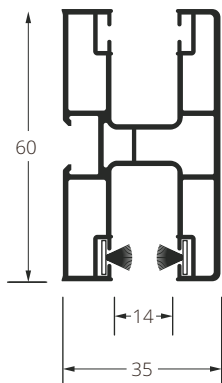
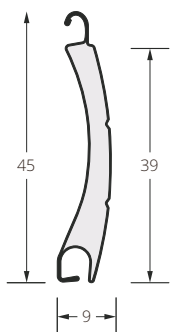

* RAL numbers mean the colours similar to real, the most reliable way to verify is our colour sampler.

- 1. – longer realization term.
- 2. – painting surcharge, longer realization term.
- 4. – minimum order is 15 m².

Colour	symbol	RAL*	Curtain profile	End slat	PVC Guide	Box	Revision flap	
silver	01	9006	✓	✓				standard colours
white	02	9016	✓	✓	✓	✓	✓	
grey	03	7038	✓	✓				
dark beige	04	1019	✓					
beige	05	1013	✓	✓				
dark brown	08	8019	✓	✓				
brown	09	8014	✓	✓				
crème white	15	9001	✓	1				
ivory	16	1015	✓	2				
ultra white	22		1	1				
anthracite grey	23	7016	✓	✓				
light grey	31	7047	✓	1				
dark wood	06		1					
light wood	07		1					
mahogany	26		✓					
walnut	28		✓	✓				
golden oak	30		✓	✓				
swamp oak	36		✓					
winchester	52		✓					
light oak	79		✓					
grey	03R	715505			✓		1	woodlike foil renolite (surcharge)
anthracite	23R	701605		1	✓		✓	
anthracite smooth	23RG	701605-083		1	✓		1	
mahogany	26R	2065021		✓	✓		1	
walnut	28R	2178007		✓	✓		✓	
golden oak	30R	2178001		✓	✓		✓	
basalt grey	33R	701205			1		1	
basalt grey smooth	33RG	701205-083			1		1	
quartz grey	34R	701205			1		1	
swamp oak	36R	2052089		✓	✓			
winchester	52R	49240		✓	✓		✓	
palisander	54R	851805			1		1	
chocolate brown	55R	887505			1		1	
crème white	66R	137905			1		1	
light oak	79R			1				
red	12	3003	4	2				non-standard (surcharge)
green	13	6005	4	2				
fir green	17	6009	4	2				
steel blue	18	5011	4	2				
burgundy	19	3005	4	2				
black	20	9005	1	2				
basalt grey	33	7012	✓	2				
quartz grey	34	7039	✓	✓				
concrete grey	35	7023	4	2				
grey aluminum	37	9007	1	2				
white pearl matt	40		4	2				
light grey pearl matt	41			2				
grey pearl matt	42			2				
anthracite grey pearl matt	43		1	1				
dark grey pearl matt	44			2				

Price list for REVO roller shutters in standard colour, PA39 profile

Net prices in EUR

Box with Ø60 pipe	Box with Ø40 pipe	Width Height	Width																							
			500	600	700	800	900	1000	1100	1200	1300	1400	1500	1600	1700	1800	1900	2000	2100	2200	2300	2400	2500	2600	2700	
165	165	500	90	94	97	103	110	117	122	129	136	142	143	157	172	180	188	197	206	214	223	232	240	257	265	
		600	93	97	101	108	115	122	129	135	142	149	156	173	186	195	204	213	223	232	241	250	259	268	277	
		700	95	101	105	113	120	128	134	142	149	157	169	190	199	209	220	230	239	250	259	269	292	306	315	
		800	98	103	109	117	124	132	139	147	160	170	180	200	211	222	232	242	253	264	274	286	295	317	320	
		900	102	108	113	121	129	137	145	159	170	181	192	213	225	236	248	259	270	282	292	304	315	327	339	
		1000	103	110	116	124	133	141	157	168	179	190	202	215	237	250	263	275	289	301	314	327	340	352	364	377
		1100	108	114	120	130	138	155	167	178	190	202	215	237	250	263	275	289	301	314	327	340	352	364	377	
		1200	111	118	125	134	150	163	176	189	201	214	227	250	265	277	291	304	318	332	345	358	372	386	400	
		1300	113	120	128	143	156	170	184	197	210	224	237	261	275	290	304	318	332	346	360	374	387	401	415	
		1400	115	125	133	150	164	178	193	207	221	235	249	274	289	304	319	333	349	364	378	393	408	423	438	
		1500	117	128	141	156	171	186	201	215	230	245	260	286	301	316	332	347	362	378	393	409	424	439	454	
		1600	119	130	148	163	179	195	210	225	241	257	273	298	315	331	348	364	380	396	412	428	445	461	477	
		1700	121	137	153	169	186	202	217	234	250	266	282	309	326	343	360	377	393	410	427	444	461	477	494	
		1800	126	142	159	176	194	210	227	244	261	278	294	323	340	358	375	393	410	427	445	463	481	499	517	
205	205	1900	130	147	165	182	199	217	235	252	269	287	305	333	351	369	387	406	424	442	460	478	496	514	532	
		2000	134	155	171	189	207	225	244	262	281	299	317	346	365	384	403	422	441	460	479	498	517	535	554	
		2100	138	158	177	196	215	235	253	273	292	310	330	360	379	399	419	439	458	478	498	517	537	557	577	
		2200	142	163	182	202	222	242	262	281	300	320	340	370	391	411	432	451	472	492	512	533	553	573	594	
		2300	146	169	189	210	230	250	270	291	311	332	352	383	404	426	446	468	489	510	531	552	573	594		
		2400	150	173	194	215	236	257	278	299	320	341	362	394	416	437	459	481	503	524	546	568	589			
		2500	154	178	200	223	244	266	287	309	331	353	374	407	429	452	475	497	519	542	565	586				
		2600	159	181	203	225	248	270	292	315	336	360	382	415	438	461	485	507	530	553	576					
		2700	163	186	209	232	256	278	302	325	348	370	394	428	452	476	500	523	547	571						
		2800	167	191	215	239	263	287	310	334	359	383	407	441	465	491	515	540	564							

Surcharge for guides	
non-standard colour or woodlike colour (for 2 pcs.)	aluminum varnished in RAL colour (for 2 pcs.)
5	16
6	19
8	22
9	25
10	28
11	31
12	34
13	38
14	41
15	44
16	47
17	50
18	53
19	56
20	59
22	63
23	66
24	69
25	72
26	75
27	78
28	81
29	84
30	88

Surcharges:	Winding pipe Ø40 ←												→ Winding pipe Ø60											
Non-standard revision flap	5	6	7	8	9	10	11	12	13	14	15	16	17	18	19	20	21	22	23	24	25	26	27	
Woodlike end slat	4	5	5	6	7	8	8	9	10	11	11	12	13	14	14	15	16	17	17	18	19	20	20	
Woodlike end slat RENOLIT	4	5	6	7	8	9	9	10	11	12	13	14	14	15	16	17	18	19	20	20	21	22	23	
Block hangers	2 pieces / 18 €						3 pieces / 27 €						4 pieces / 36 €						5 pieces / 45 €					

Specification

- 10 Nm short Ø 40 motor
- 10 Nm Ø 40 motor
- 13 Nm Ø 40 motor
- 13 Nm Ø 60 motor
- 23 Nm Ø 60 motor

Standard equipment includes:

- white PVC box with insulation in sizes customized to the height of the roller shutter with angle irons for building in from the outside and from the inside.
- white revision flap in a bottom part of the box.
- a winding pipe (shaft) with a diameter of 40 or 60 mm, depending on the dimensions of the roller shutter.
- Pa 39 profile, perforated, standard colour.
- manual control for tape - white box coiler, up to 12 kg.
- 56 mm end slat in standard colour with a rubber seal.
- white PVC guides.
- cable extraction outside in electric roller shutter on the side of the box.
- steel hangers.
- stopper.
- packing of box and guides with stretch wrap.

For an extra charge or optional (no information on order form means that the standard will be produce):

- box coiler in brown or anthracite colour (no surcharge) 0 € pcs.
- tape in brown or anthracite colour (no surcharge) 0 € pcs.
- curtain profile without perforation (no surcharge) 0 € pcs.
- white revision flap in a front part of the box (no surcharge) 0 € pcs.
- box without the angle irons for building in (no surcharge) 0 € pcs.
- bottom end caps of the guides 1 € set
- packing in corrugated cardboard 4 € rm
- packing in a 6 mm thick cardboard 15 € rm
- packing the box and the curtain profile separately 15 € rm
- winder crank for a tape up to 20 kg 30 € set
- end slat varnishing 15 € pcs.
- surcharge to curtain profile - woodlike colour 5 € m²
- surcharge to curtain profile - non-standard colour 8 € m²
- automatic lock (only roller shutters without motor) 30 € set
- spring 10 kg Ø 40 + cylinder lock 94 € set
- spring 15 kg Ø 40 + cylinder lock 106 € set
- spring 15 kg Ø 60 + cylinder lock 112 € set
- spring 24 kg Ø 60 + cylinder lock 115 € set
- steel reinforcement console (no possibility to install in 165 Box) 58 € szt
- mounting anchor for connecting the box with the headroom 0,50 € pcs.
- drive selected according to legend, drives prices on pages 50 - 57.
- remote control with the appropriate number of channels, prices on pages 50 - 57.
- push-button switch selectable on pages 50 - 57

Price list for REVO roller shutters in woodlike colour, PA39 profile

		Net prices in EUR																									
Box with Ø60 pipe	Box with Ø40 pipe	Width Height	500	600	700	800	900	1000	1100	1200	1300	1400	1500	1600	1700	1800	1900	2000	2100	2200	2300	2400	2500	2600	2700		
165	165	500	91	98	106	113	120	128	135	142	150	156	163	169	193	202	211	221	231	240	249	260	269	278	287		
		600	95	103	111	119	127	134	142	150	157	165	173	191	208	219	229	240	250	260	270	281	291	302	312		
		700	101	109	117	125	133	141	149	157	165	174	191	213	224	236	247	258	269	281	291	303	314	326	337		
		800	103	112	120	129	138	146	155	163	181	193	204	225	237	249	262	273	285	297	308	320	332	345	357		
		900	108	117	126	135	144	152	161	182	194	206	218	240	253	266	279	291	304	317	329	342	355	368	382		
		1000	110	120	130	139	149	158	178	191	204	216	230	253	266	280	293	307	320	333	347	360	373	387	400		
		1100	116	126	135	145	155	176	190	204	217	231	244	269	283	297	311	325	340	353	368	382	396	410	424		
		1200	120	130	141	151	173	187	201	215	230	244	258	283	299	314	329	344	359	374	389	403	419	434	449		
		1300	123	134	144	165	180	195	210	225	240	255	270	296	312	327	343	359	374	390	406	422	437	452	467		
		1400	128	138	150	173	189	205	221	237	253	269	284	311	328	344	361	377	394	410	427	443	460	476	493		
		1500	133	142	164	181	197	213	230	247	263	280	296	324	341	358	375	393	410	427	444	461	478	496	514		
		1600	138	148	172	189	207	224	241	258	276	293	310	340	357	375	393	411	429	448	465	483	502	519	537		
205	205	1700	142	160	178	196	214	233	250	269	287	304	323	352	370	389	408	426	445	464	482	501	520	539	557		
		1800	148	167	186	205	224	242	262	281	299	318	336	367	386	406	425	445	465	484	503	523	543	562	581		
		1900	153	173	192	212	231	251	270	290	309	329	349	379	399	419	440	460	480	501	520	541	561	581	600		
		2000	158	179	199	220	240	261	281	302	322	343	363	394	415	436	458	478	499	520	541	562	583	605	625		
		2100	165	187	208	229	250	271	292	314	335	356	377	409	432	453	476	497	519	541	562	585	606	628	650		
		2200	170	192	214	236	257	280	302	324	345	367	389	422	444	467	489	512	535	557	580	602	624	648	671		
		2300	176	199	222	244	267	290	312	335	358	381	403	437	460	483	507	530	554	577	600	624	648	671			
		2400	182	205	228	252	275	298	322	345	368	392	415	449	474	498	521	545	570	594	618	642	666				
		2500	187	211	236	260	284	308	332	357	381	406	429	465	489	514	539	564	589	614	638	663					
		2600	189	214	239	264	289	314	339	364	389	414	438	474	500	525	551	576	602	628	653						
2700	195	221	247	273	298	324	349	375	401	427	452	489	515	542	568	595	621	648									
2800	201	228	254	281	307	333	360	386	414	440	466	504	531	559	586	613	640										

Surcharge for guides	
aluminum varnished in RAL colour (for 2 pcs.)	16
	19
	22
	25
	28
	31
	34
	38
	41
	44
	47
	50
	53
	56
	59
	63
	66
	69
	72
	75
	78
	81
	84
	88

Surcharges:	Winding pipe Ø40													Winding pipe Ø60									
Non-standard revision flap	5	6	7	8	9	10	11	12	13	14	15	16	17	18	19	20	21	22	23	24	25	26	27
Woodlike end slat RENOLIT	1	1	1	1	1	2	2	2	2	2	2	2	3	3	3	3	3	3	3	4	4	4	4
Block hangers	2 pieces / 18 €						3 pieces / 27 €						4 pieces / 36 €					5 pieces / 45 €					

Specification	
- 10 Nm short Ø 40 motor	
- 10 Nm Ø 40 motor	
- 13 Nm Ø 40 motor	
- 13 Nm Ø 60 motor	
- 23 Nm Ø 60 motor	

Standard equipment includes:

- white PVC box with insulation in sizes customized to the height of the roller shutter with angle irons for building in from the outside and from the inside.
- white revision flap in a bottom part of the box.
- a winding pipe (shaft) with a diameter of 40 or 60 mm, depending on the dimensions of the roller shutter.
- profile Pa 39 perforated, woodlike colour.
- manual control for tape - white box coiler, up to 12 kg.
- 56 mm high end slat varnished in woodlike colour with a rubber seal.
- PVC woodlike or non-standard guides
- cable extraction outside in electric roller shutter on the side of the box.
- steel hangers.
- stopper.
- packing of box and guides with stretch wrap.

For an extra charge or optional (no information on order form means that the standard will be produce):

- box coiler in brown or anthracite colour (no surcharge) 0 € pcs.
- tape in brown or anthracite colour (no surcharge) 0 € pcs.
- curtain profile without perforation (no surcharge) 0 € pcs.
- white revision flap in a front part of the box (no surcharge) 0 € pcs.
- box without the angle irons for building in (no surcharge) 0 € pcs.
- bottom end caps of the guides 1 € set
- packing in corrugated cardboard 4 € rm
- packing in a 6 mm thick cardboard 15 € rm
- packing the box and the curtain profile separately 15 € rm
- winder crank for a tape up to 20 kg 30 € set
- end slat varnishing 15 € pcs.
- surcharge to curtain profile - non-standard colour 3 € m²
- automatic lock (only roller shutters without motor) 30 € set
- spring 10 kg Ø 40 + cylinder lock 94 € set
- spring 15 kg Ø 40 + cylinder lock 106 € set
- spring 15 kg Ø 60 + cylinder lock 112 € set
- spring 24 kg Ø 60 + cylinder lock 115 € set
- steel reinforcement console (no possibility to install in 165 Box) 58 € szt
- mounting anchor for connecting the box with the headroom 0,50 € pcs.
- drive selected according to legend, drives prices on pages 50 - 57.
- remote control with the appropriate number of channels, prices on pages 50 - 57.
- push-button switch selectable on pages 50 - 57

Price list for REVO roller shutters in non-standard colour, PA39 profile

		Net prices in EUR																									
Box with Ø60 pipe	Box with Ø40 pipe	Width Height	500	600	700	800	900	1000	1100	1200	1300	1400	1500	1600	1700	1800	1900	2000	2100	2200	2300	2400	2500	2600	2700		
165	165	500	115	125	135	144	152	162	171	180	190	198	207	215	245	256	268	281	293	304	317	330	341	353	365		
		600	121	131	141	151	161	171	180	190	200	210	219	243	265	278	291	304	317	330	343	357	370	384	397		
		700	128	138	148	158	169	179	189	200	210	221	243	271	285	299	314	327	341	356	370	385	399	414	428		
		800	131	142	153	164	175	186	197	207	230	245	259	287	301	317	332	347	361	377	392	407	422	438	454		
		900	137	148	160	171	182	193	205	231	246	262	276	305	322	338	354	370	386	402	418	435	451	468	485		
		1000	140	152	165	177	189	201	227	243	259	275	292	321	339	356	372	390	406	423	440	457	474	491	509		
		1100	147	160	172	185	198	224	241	259	275	293	310	341	359	377	395	414	432	449	467	486	503	521	538		
		1200	152	166	179	191	219	237	255	274	292	310	329	360	379	399	417	436	456	475	494	512	532	551	570		
		1300	157	170	183	210	229	248	267	286	305	324	343	375	396	416	436	456	476	496	516	536	555	574	593		
		1400	162	176	190	220	240	261	280	300	321	341	361	395	416	437	458	479	500	521	542	563	584	605	625		
		1500	168	181	208	229	250	271	292	314	335	356	375	411	433	455	476	499	520	542	563	586	608	630	653		
		1600	175	187	219	240	263	284	307	329	350	373	394	431	454	476	499	522	545	568	591	614	637	659	683		
		205	205	1700	181	203	226	249	272	296	318	341	364	386	410	446	470	494	518	541	565	589	613	637	660	684	708
1800	188			213	236	260	284	308	332	356	380	403	427	466	490	515	540	565	590	615	639	664	689	714	739		
1900	195			219	244	269	294	319	343	368	393	418	443	481	507	532	559	584	609	636	661	687	712	738	762		
2000	201			227	253	279	305	332	357	383	409	435	461	500	527	554	581	607	634	661	688	714	741	768	794		
2100	210			237	264	290	318	345	371	399	425	452	479	520	548	575	604	632	659	687	714	742	770	798	826		
2200	216			244	272	299	327	356	383	411	438	466	494	536	564	593	622	650	679	708	736	764	793	823	851		
2300	223			253	282	310	339	368	397	425	455	484	512	555	585	614	644	674	703	733	762	792	823	852			
2400	231			260	289	319	349	379	409	438	468	497	527	571	602	632	662	692	724	754	785	815	846				
2500	238			268	299	330	360	391	422	453	484	515	545	590	622	653	685	716	748	780	810	842					
2600	240			272	304	335	367	399	431	462	493	525	556	602	634	667	700	732	764	797	829						
2700	248	280	314	346	379	411	444	476	509	542	574	621	655	688	722	755	789	823									
2800	255	289	322	357	390	424	458	491	525	559	592	640	675	709	744	778	813										

Surcharge for guides	
aluminum varnished in RAL colour (for 2 pcs.)	16
	19
	22
	25
	28
	31
	34
	38
	41
	44
	47
	50
	53
	56
	59
	63
	66
	69
	72
	75
	78
	81
	84
	88

Surcharges:	Winding pipe Ø40													Winding pipe Ø60												
Non-standard revision flap	5	6	7	8	9	10	11	12	13	14	15	16	17	18	19	20	21	22	23	24	25	26	27			
Woodlike end slat RENOLIT	1	1	1	1	1	2	2	2	2	2	2	2	3	3	3	3	3	3	3	4	4	4	4			
Block hangers	2 pieces / 18 €						3 pieces / 27 €						4 pieces / 36 €						5 pieces / 45 €							

Specification	
- 10 Nm short Ø 40 motor	
- 10 Nm Ø 40 motor	
- 13 Nm Ø 40 motor	
- 13 Nm Ø 60 motor	
- 23 Nm Ø 60 motor	

Standard equipment includes:

- white PVC box with insulation in sizes customized to the height of the roller shutter with angle irons for building in from the outside and from the inside.
- white revision flap in a bottom part of the box.
- a winding pipe (shaft) with a diameter of 40 or 60 mm, depending on the dimensions of the roller shutter.
- Pa 39 profile, perforated, non-standard colour.
- manual control for tape - white box coiler, up to 12 kg.
- 56 mm high end slat in non-standard colour with a rubber seal.
- PVC woodlike or non-standard guides
- cable extraction outside in electric roller shutter on the side of the box.
- steel hangers.
- stopper.
- packing of box and guides with stretch wrap.

For an extra charge or optional (no information on order form means that the standard will be produce):

- box coiler in brown or anthracite colour (no surcharge) 0 € pcs.
- tape in brown or anthracite colour (no surcharge) 0 € pcs.
- curtain profile without perforation (no surcharge) 0 € pcs.
- white revision flap in a front part of the box (no surcharge) 0 € pcs.
- box without the angle irons for building in (no surcharge) 0 € pcs.
- bottom end caps of the guides 1 € set
- packing in corrugated cardboard 4 € rm
- packing in a 6 mm thick cardboard 15 € rm
- packing the box and the curtain profile separately 15 € rm
- winder crank for a tape up to 20 kg 30 € set
- automatic lock (only roller shutters without motor) 30 € set
- spring 10 kg Ø 40 + cylinder lock 94 € set
- spring 15 kg Ø 40 + cylinder lock 106 € set
- spring 15 kg Ø 60 + cylinder lock 112 € set
- spring 24 kg Ø 60 + cylinder lock 115 € set
- steel reinforcement console (no possibility to install in 165 Box) 58 € szt
- mounting anchor for connecting the box with the headroom 0,50 € pcs.
- drive selected according to legend, drives prices on pages 50 - 57.
- remote control with the appropriate number of channels, prices on pages 50 - 57.
- push-button switch selectable on pages 50 - 57

- PVC box, insulated.
- 60 mm wide PVC guides or ALU for an extra charge.
- 43 mm aluminum profile filled with polyurethane foam (weight 2,6 kg/m³).
- maximum dimensions: width 2700 mm, height 2800 mm (for 1 class wind resistance according to EN13659).
- manual drive in the form of a box coiler for tape (maximum curtain profile weight: up to 12 kg).
- maximum roller shutter surface 9 m²
- recommended by the system provider stability for the curtain is obtained for surface up to 7 m². Above this value slight undulations of the curtain may occur - however, this does not affect functionality and roller shutter fulfills all criteria specified by the norm.



REVO

43 mm „PA-43“ aluminum profile.

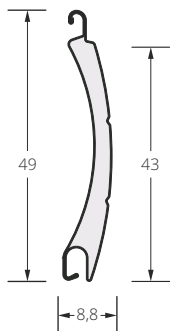

"PG-60" guide.

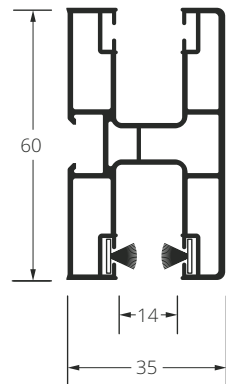

* RAL numbers mean the colours similar to real, the most reliable way to verify is our colour sampler.

- 1. – longer realization term.
- 2. – painting surcharge, longer realization term.
- 4. – minimum order is 15 m².

Colour	symbol	RAL*	Curtain profile	End slat	PVC Guide	Box	Revision flap	ALU Guide
--------	--------	------	-----------------	----------	-----------	-----	---------------	-----------

standard colours	symbol	RAL*						
silver	01	9006	✓	✓				2
white	02	9016	✓	✓	✓	✓	✓	2
grey	03	7038	✓	✓				2
dark beige	04	1019	4					
beige	05	1013	✓	✓				
dark brown	08	8019	✓	✓				2
brown	09	8014	✓	✓				2
crème white	15	9001	✓	1				
ivory	16	1015	✓	2				2
ultra white	22		1	1				
anthracite grey	23	7016	✓	✓				2
light grey	31	7047	✓	1				2

woodlike (surcharge)	symbol	RAL*						
dark wood	06		4					
mahogany	26		✓					
walnut	28		✓	✓				
golden oak	30		✓	✓				
swamp oak	36		✓					
winchester	52		✓					

woodlike, foil, renolite (surcharge)	symbol	RAL*						
grey	03R	715505			✓			1
anthracite	23R	701605		1	✓		✓	
anthracite smooth	23RG	701605-083		1	✓		1	
mahogany	26R	2065021		✓	✓		1	
walnut	28R	2178007		✓	✓		✓	
golden oak	30R	2178001		✓	✓		✓	
basalt grey	33R	701205			1		1	
basalt grey smooth	33RG	701205-083			1		1	
quartz grey	34R	701205			1		1	
swamp oak	36R	2052089		✓	✓			
winchester	52R	49240		✓	✓		✓	
palisander	54R	851805			1		1	
chocolate brown	55R	887505			1		1	
crème white	66R	137905			1		1	

non-standard (surcharge)	symbol	RAL*						
black	20	9005	1	2				2
basalt grey	33	7012	✓	2				2
quartz grey	34	7039	✓	✓				2
concrete grey	35	7023	4	2				2
grey aluminum	37	9007	1	2				2

Price list for REVO roller shutters in standard colour, PA43 profile

		Net prices in EUR																							
Box with Ø60 pipe	Box with Ø40 pipe	Width Height	500	600	700	800	900	1000	1100	1200	1300	1400	1500	1600	1700	1800	1900	2000	2100	2200	2300	2400	2500	2600	2700
165	165	500	94	98	102	109	116	124	130	137	144	151	153	169	184	192	202	211	221	229	238	248	257	275	284
		600	97	102	108	115	122	130	138	145	153	161	169	187	200	210	220	230	240	250	260	271	281	290	299
		700	100	107	113	121	129	137	145	154	162	170	184	205	216	227	238	249	260	271	282	292	303	322	340
		800	103	110	117	126	134	143	152	160	174	185	196	218	229	242	254	265	276	288	300	312	323	335	346
		900	108	115	122	131	140	149	159	174	187	198	211	233	246	258	271	284	296	309	321	334	347	360	372
		1000	111	118	126	136	145	155	172	185	197	210	223	246	259	273	286	300	313	326	340	353	366	380	393
		1100	116	123	131	142	152	170	184	197	210	224	237	262	276	291	305	319	333	348	362	377	390	404	418
		1200	119	128	136	148	165	179	194	209	223	237	252	277	293	307	323	337	353	368	383	399	414	429	445
		1300	122	131	141	157	173	188	203	219	233	249	264	290	306	322	338	354	370	385	402	418	433	448	463
		1400	125	137	146	166	181	197	214	230	246	263	279	306	323	339	356	373	390	406	423	440	457	474	491
205	205	1500	127	140	155	173	190	206	224	240	257	274	291	319	336	353	371	389	406	424	441	459	476	493	510
		1600	130	144	163	181	199	217	234	252	270	288	306	334	353	371	390	408	426	445	463	482	501	519	537
		1700	133	151	170	188	207	225	244	262	281	299	318	347	366	385	404	424	443	462	482	501	520	539	557
		1800	138	157	176	196	216	235	254	273	293	313	332	363	383	403	423	443	462	483	503	523	543	564	584
		1900	143	163	183	204	224	244	264	283	304	324	345	375	396	417	437	459	480	500	521	542	562	583	603
		2000	148	172	190	212	232	253	274	295	316	338	359	390	412	435	456	478	499	521	543	565	586	607	629
		2100	152	176	198	220	242	264	286	308	330	351	374	406	428	451	475	497	520	542	565	587	610	632	656
		2200	158	181	179	227	249	272	295	318	340	363	386	419	443	466	489	512	536	559	582	606	630	653	676
		2300	162	188	211	235	258	282	306	329	352	377	400	435	458	483	507	532	556	580	605	629	653	677	701
		2400	167	194	217	242	266	290	315	340	364	388	412	448	472	497	522	547	573	598	623	648	673	698	723
2500	172	199	224	250	275	300	325	350	377	402	427	463	488	515	541	567	593	619	645	670	695	720	745		
2600	177	202	228	254	281	306	332	358	384	410	436	472	499	526	553	580	606	633	659	685	712	738	764		
2700	182	208	235	262	289	316	343	370	397	423	451	487	515	543	572	598	626	654	681	709	737	765	793		
2800	187	214	242	271	298	326	353	381	409	437	465	503	531	561	589	618	646	675	703	732	760	789	818		

Surcharge for guides	
non-standard colour or woodlike colour (for 2 pcs.)	aluminum varnished in RAL colour (for 2 pcs.)
5	16
6	19
8	22
9	25
10	28
11	31
12	34
13	38
14	41
15	44
16	47
17	50
18	53
19	56
20	59
22	63
23	66
24	69
25	72
26	75
27	78
28	81
29	84
30	88

Surcharges:	Winding pipe Ø40														Winding pipe Ø60									
Non-standard revision flap	5	6	7	8	9	10	11	12	13	14	15	16	17	18	19	20	21	22	23	24	25	26	27	
Woodlike end slat	4	5	5	6	7	8	8	9	10	11	11	12	13	14	14	15	16	17	17	18	19	20	20	
Woodlike end slat RENOLIT	4	5	6	7	8	9	9	10	11	12	13	14	14	15	16	17	18	19	20	20	21	22	23	
Block hangers	2 pieces / 18 €							3 pieces / 27 €							4 pieces / 36 €					5 pieces / 45 €				

Specification

- 10 Nm short Ø 40 motor
- 10 Nm Ø 40 motor
- 13 Nm Ø 40 motor
- 13 Nm Ø 60 motor
- 23 Nm Ø 60 motor

Standard equipment includes:

- white PVC box with insulation in sizes customized to the height of the roller shutter with angle irons for building in from the outside and from the inside.
- white revision flap in a bottom part of the box.
- a winding pipe (shaft) with a diameter of 40 or 60 mm, depending on the dimensions of the roller shutter.
- Pa 43 profile, perforated, standard colour
- manual control for tape - white box coiler, up to 12 kg.
- 56 mm end slat in standard colour with a rubber seal.
- white PVC guides.
- cable extraction outside in electric roller shutter on the side of the box.
- steel hangers.
- stopper.
- packing of box and guides with stretch wrap.

For an extra charge or optional (no information on order form means that the standard will be produce):

- box coiler in brown or anthracite colour (no surcharge) 0 € pcs.
- tape in brown or anthracite colour (no surcharge) 0 € pcs.
- curtain profile without perforation (no surcharge) 0 € pcs.
- white revision flap in a front part of the box (no surcharge) 0 € pcs.
- box without the angle irons for building in (no surcharge) 0 € pcs.
- bottom end caps of the guides 1 € set
- packing in corrugated cardboard 4 € rm
- packing in a 6 mm thick cardboard 15 € rm
- packing the box and the curtain profile separately 15 € rm
- winder crank for a tape up to 20 kg 30 € set
- end slat varnishing 15 € pcs.
- surcharge to curtain profile - woodlike colour 7 € m²
- surcharge to curtain profile - non-standard colour 10 € m²
- automatic lock (only roller shutters without motor) 30 € set
- spring 10 kg Ø 40 + cylinder lock 94 € set
- spring 15 kg Ø 40 + cylinder lock 106 € set
- spring 15 kg Ø 60 + cylinder lock 112 € set
- spring 24 kg Ø 60 + cylinder lock 115 € set
- steel reinforcement console (no possibility to install in 165 Box) 58 € szt
- mounting anchor for connecting the box with the headroom 0,50 € pcs.
- drive selected according to legend, drives prices on pages 50 - 57.
- remote control with the appropriate number of channels, prices on pages 50 - 57.
- push-button switch selectable on pages 50 - 57

Price list for REVO roller shutters in the woodlike colour, PA43 profile

		Net prices in EUR																									
Box with Ø60 pipe	Box with Ø40 pipe	Width Height	500	600	700	800	900	1000	1100	1200	1300	1400	1500	1600	1700	1800	1900	2000	2100	2200	2300	2400	2500	2600	2700		
165	165	500	94	102	111	119	126	135	142	150	158	166	164	180	205	214	224	236	245	255	265	276	286	296	306		
		600	100	109	117	126	134	143	151	159	169	176	185	205	223	234	245	256	267	279	290	301	312	324	335		
		700	105	114	123	133	142	151	160	169	178	187	206	229	241	253	266	277	289	302	314	326	339	351	364		
		800	109	118	128	138	148	157	167	177	196	208	220	244	256	270	283	296	308	321	334	347	360	374	387		
		900	114	124	134	145	155	165	175	197	210	224	237	261	274	288	303	316	330	344	358	372	386	401	415		
		1000	117	129	140	151	161	172	194	208	222	236	250	275	290	305	319	334	349	364	379	393	408	423	438		
		1100	124	135	146	157	170	192	207	222	237	252	267	292	308	324	340	356	372	387	403	419	435	450	465		
		1200	129	140	153	164	188	203	219	236	252	267	284	310	327	344	360	377	394	410	427	444	461	477	494		
		1300	133	145	157	179	196	213	230	247	264	281	297	325	343	360	378	395	412	430	448	465	482	499	516		
		1400	138	150	163	189	207	224	242	260	278	296	314	342	361	379	398	416	435	453	471	490	508	527	545		
205	205	1500	144	155	179	197	216	234	253	272	290	309	327	357	377	395	415	435	453	472	491	511	530	549	570		
		1600	149	161	188	207	227	246	266	286	305	325	344	375	395	415	435	456	476	497	516	537	557	577	597		
		1700	154	174	195	215	236	256	276	296	317	337	358	390	410	431	452	474	495	516	537	558	579	600	621		
		1800	161	182	203	225	246	267	289	310	332	353	374	407	428	451	472	495	517	539	561	582	605	627	649		
		1900	167	188	211	233	255	277	299	322	344	366	389	421	444	467	490	513	535	559	581	604	627	649	672		
		2000	172	196	219	242	266	289	312	335	358	382	404	438	462	486	510	534	557	581	605	629	653	677	700		
		2100	180	204	228	252	276	301	324	349	373	398	421	456	481	505	531	556	580	605	630	655	680	704	729		
		2200	186	211	236	260	285	310	335	360	385	410	435	471	497	522	547	573	598	624	650	675	701	727	753		
		2300	191	218	245	270	295	322	348	373	400	426	451	487	515	541	568	595	621	648	674	701	727	754	781		
		2400	198	225	251	278	305	332	358	385	411	439	465	503	530	557	585	612	639	667	695	722	750	777	805		
2500	204	232	260	288	315	343	370	399	426	454	481	520	548	577	605	634	662	690	718	747	775	804	833				
2600	207	236	265	293	322	350	379	407	436	464	492	532	561	590	620	648	677	707	736	765	794	823	852				
2700	214	244	273	303	332	361	391	420	449	479	508	549	579	610	640	670	700	730	760	791	822	852	883				
2800	220	250	281	312	343	373	403	433	464	495	525	566	597	628	659	691	722	753	785	816	847	879	910				

Winding pipe Ø40 ← | → Winding pipe Ø60

Surcharges:																												
Non-standard revision flap		5	6	7	8	9	10	11	12	13	14	15	16	17	18	19	20	21	22	23	24	25	26	27				
Woodlike end slat RENOLIT		1	1	1	1	1	2	2	2	2	2	2	2	3	3	3	3	3	3	3	4	4	4	4				
Block hangers		2 pieces / 18 €						3 pieces / 27 €						4 pieces / 36 €						5 pieces / 45 €								

Surcharge for guides	
aluminum varnished in RAL colour (for 2 pcs.)	
16	
19	
22	
25	
28	
31	
34	
38	
41	
44	
47	
50	
53	
56	
59	
63	
66	
69	
72	
75	
78	
81	
84	
88	

Specification	
- 10 Nm short Ø 40 motor	
- 10 Nm Ø 40 motor	
- 13 Nm Ø 40 motor	
- 13 Nm Ø 60 motor	
- 23 Nm Ø 60 motor	

Standard equipment includes:

- white PVC box with insulation in sizes customized to the height of the roller shutter with angle irons for building in from the outside and from the inside.
- white revision flap in a bottom part of the box.
- a winding pipe (shaft) with a diameter of 40 or 60 mm, depending on the dimensions of the roller shutter.
- profile Pa 43 perforated, woodlike colour.
- manual control for tape - white box coiler, up to 12 kg.
- 56 mm high end slat varnished in woodlike colour with a rubber seal.
- PVC woodlike or non-standard guides.
- cable extraction outside in electric roller shutter on the side of the box.
- steel hangers.
- stopper.
- packing of box and guides with stretch wrap.

For an extra charge or optional (no information on order form means that the standard will be produce):

- box coiler in brown or anthracite colour (no surcharge) 0 € pcs.
- tape in brown or anthracite colour (no surcharge) 0 € pcs.
- curtain profile without perforation (no surcharge) 0 € pcs.
- white revision flap in a front part of the box (no surcharge) 0 € pcs.
- box without the angle irons for building in (no surcharge) 0 € pcs.
- bottom end caps of the guides 1 € set
- packing in corrugated cardboard 4 € rm
- packing in a 6 mm thick cardboard 15 € rm
- packing the box and the curtain profile separately 15 € rm
- winder crank for a tape up to 20 kg 30 € set
- end slat varnishing 15 € pcs.
- surcharge to curtain profile - non-standard colour 3 € m²
- automatic lock (only roller shutters without motor) 30 € set
- spring 10 kg Ø 40 + cylinder lock 94 € set
- spring 15 kg Ø 40 + cylinder lock 106 € set
- spring 15 kg Ø 60 + cylinder lock 112 € set
- spring 24 kg Ø 60 + cylinder lock 115 € set
- steel reinforcement console (no possibility to install in 165 Box) 58 € szt
- mounting anchor for connecting the box with the headroom 0,50 € pcs.
- drive selected according to legend, drives prices on pages 50 - 57.
- remote control with the appropriate number of channels, prices on pages 50 - 57.
- push-button switch selectable on pages 50 - 57

Price list for REVO roller shutters in a non-standard colour, PA43 profile

		Net prices in EUR																							
Box with Ø60 pipe	Box with Ø40 pipe	Width Height	500	600	700	800	900	1000	1100	1200	1300	1400	1500	1600	1700	1800	1900	2000	2100	2200	2300	2400	2500	2600	2700
165	165	500	117	128	139	148	158	169	178	188	198	208	205	225	256	268	281	294	307	319	332	346	358	370	383
		600	125	136	146	157	168	178	189	199	211	221	231	256	279	292	306	320	334	348	362	377	390	404	418
		700	132	143	154	165	177	189	200	212	222	234	258	286	301	316	332	346	361	377	392	407	424	438	454
		800	136	148	160	172	185	197	209	221	245	260	275	304	320	337	353	369	385	402	417	433	451	467	484
		900	143	155	168	181	194	206	219	246	263	280	296	326	343	360	378	395	412	431	448	465	483	501	519
		1000	146	161	174	188	201	215	242	260	278	295	313	344	363	381	399	418	436	455	474	491	510	529	547
		1100	155	169	183	197	212	240	259	278	296	315	334	366	386	406	425	445	465	484	504	524	543	562	581
		1200	161	176	191	205	235	254	274	294	314	334	355	387	409	430	451	471	492	513	534	555	576	597	618
		1300	165	181	196	224	246	266	287	308	330	351	371	406	429	450	472	494	515	537	560	581	603	624	645
		1400	173	188	204	236	258	281	303	325	347	369	392	428	451	474	497	520	544	566	589	612	636	658	681
205	205	1500	179	194	223	247	270	293	316	340	363	386	409	446	471	494	518	544	566	590	614	639	663	687	713
		1600	186	201	235	259	284	308	332	357	381	406	430	468	494	519	544	570	595	621	645	671	697	722	747
		1700	193	218	243	269	294	320	346	370	397	421	448	487	512	539	565	592	619	645	671	698	724	750	776
		1800	201	228	254	281	308	334	361	388	415	441	467	509	535	564	590	619	646	674	701	728	756	783	811
		1900	208	236	263	291	319	346	373	402	430	458	485	526	555	583	612	641	669	698	726	755	783	812	840
		2000	215	245	273	303	332	361	390	418	448	477	505	548	578	607	638	667	697	726	757	786	816	846	875
		2100	225	255	285	315	346	376	406	436	466	497	526	570	602	632	664	695	725	756	787	818	849	880	911
		2200	232	263	294	325	356	388	419	451	481	512	544	589	621	653	684	716	748	780	812	844	876	909	941
		2300	239	273	306	337	369	403	434	467	500	532	564	610	644	676	709	743	776	810	842	876	910	943	976
		2400	248	281	314	347	381	415	448	481	514	548	581	628	663	697	731	765	799	834	868	902	937	971	1006
2500	256	290	325	360	394	429	463	498	533	568	602	650	685	721	757	792	827	863	897	934	969	1005	1040		
2600	259	295	331	366	402	438	474	509	545	580	615	665	701	738	775	811	846	884	920	956	992	1029	1065		
2700	267	304	341	378	415	451	488	525	562	599	636	686	724	762	800	837	875	913	951	989	1027	1065	1104		
2800	275	313	351	390	428	466	504	541	580	619	656	707	747	785	824	863	902	941	981	1020	1059	1098	1137		

Surcharge for guides	
aluminum varnished in RAL colour (for 2 pcs.)	
16	
19	
22	
25	
28	
31	
34	
38	
41	
44	
47	
50	
53	
56	
59	
63	
66	
69	
72	
75	
78	
81	
84	
88	

Surcharges:																												
Non-standard revision flap		5	6	7	8	9	10	11	12	13	14	15	16	17	18	19	20	21	22	23	24	25	26	27				
Woodlike end slat RENOLIT		1	1	1	1	1	2	2	2	2	2	2	2	3	3	3	3	3	3	3	4	4	4	4				
Block hangers		2 pieces / 18 €							3 pieces / 27 €							4 pieces / 36 €							5 pieces / 45 €					

Specification

- 10 Nm short Ø 40 motor
- 10 Nm Ø 40 motor
- 13 Nm Ø 40 motor
- 13 Nm Ø 60 motor
- 23 Nm Ø 60 motor

Standard equipment includes:

- white PVC box with insulation in sizes customized to the height of the roller shutter with angle irons for building in from the outside and from the inside.
- white revision flap in a bottom part of the box.
- a winding pipe (shaft) with a diameter of 40 or 60 mm, depending on the dimensions of the roller shutter.
- Pa 43 profile, perforated, non-standard colour.
- manual control for tape - white box coiler, up to 12 kg.
- 56 mm end slat in non-standard colour with a rubber seal.
- PVC woodlike or non-standard guides.
- cable extraction outside in electric roller shutter on the side of the box.
- steel hangers.
- stopper.
- packing of box and guides with stretch wrap.

For an extra charge or optional (no information on order form means that the standard will be produce):

- box coiler in brown or anthracite colour (no surcharge) 0 € pcs.
- tape in brown or anthracite colour (no surcharge) 0 € pcs.
- curtain profile without perforation (no surcharge) 0 € pcs.
- white revision flap in a front part of the box (no surcharge) 0 € pcs.
- box without the angle irons for building in (no surcharge) 0 € pcs.
- bottom end caps of the guides 1 € set
- packing in corrugated cardboard 4 € rm
- packing in a 6 mm thick cardboard 15 € rm
- packing the box and the curtain profile separately 15 € rm
- winder crank for a tape up to 20 kg 30 € set
- automatic lock (only roller shutters without motor) 30 € set
- spring 10 kg Ø 40 + cylinder lock 94 € set
- spring 15 kg Ø 40 + cylinder lock 106 € set
- spring 15 kg Ø 60 + cylinder lock 112 € set
- spring 24 kg Ø 60 + cylinder lock 115 € set
- steel reinforcement console (no possibility to install in 165 Box) 58 € szt
- mounting anchor for connecting the box with the headroom 0,50 € pcs.
- drive selected according to legend, drives prices on pages 50 - 57.
- remote control with the appropriate number of channels, prices on pages 50 - 57.
- push-button switch selectable on pages 50 - 57

electric drives
NOTE! - depending on availability, drives from different manufacturers are used!

description	Product name	net price
Ø40 shaft	10 Nm wired motor (from 621mm wide)	52,50 €
Ø40 shaft	Wired 10 Nm short motor (for roller shutters above 550mm wide)	75,00 €
Ø40 shaft	13 Nm wired motor	80,00 €
Ø60/Ø70 shaft	13/15 Nm wired motor	80,00 €
Ø60/Ø70 shaft	Wired 10 Nm short motor (for roller shutters above 480mm wide)	92,50 €
Ø60/Ø70 shaft	20 Nm wired motor	70,00 €
Ø60/Ø70 shaft	40 Nm wired motor	100,00 €
Ø60/Ø70 shaft	Motor 20 Nm with emergency opening (for roller shutters above 800mm wide)	162,50 €
Ø60/Ø70 shaft	Motor 30 Nm with emergency opening	175,00 €
Ø60/Ø70 shaft	Motor 40 Nm with emergency opening	187,50 €
Ø60/Ø70 shaft	Motor 50 Nm with emergency opening	162,50 €
Ø60/Ø70 shaft	Motor 60 Nm with emergency opening	212,50 €
Ø60/Ø70 shaft	Motor 100 Nm with emergency opening	250,00 €
Ø60/Ø70 shaft	Motor 140 Nm with emergency opening	287,50 €

accessories

description	Product name	net price
	Flush-mounted push-button switch	11,25 €
	Flush-mounted push-button switch with support (no need to hold the push-button)	12,50 €
	Surface-mounted push-button switch	15,00 €
	Surface-mounted push-button switch with support (no need to hold the push-button)	16,25 €
	Three-position SOMFY Smoove UNO push-button switch without support	27,50 €
	Three-position SOMFY Smoove DUO push-button switch without support, double	37,50 €
	Three-position SOMFY Smoove UNO push-button switch with support	27,50 €
	Three-position SOMFY Smoove DUO push-button switch with support, double	37,50 €
	Aluprof key switch	62,50 €
	R3 transmitter	85,00 €
	MR2 transmitter	37,50 €

SELVE drives and accessories

description	Product name	net price
Ø60 shaft	SP 10 Nm Wired motor (for roller shutters above 670mm wide)	137,50 €
Ø60 shaft	SP 15 Nm Wired motor	150,00 €
Ø60 shaft	SP 20 Nm Wired motor	162,50 €
Ø60 shaft	SP 30 Nm Wired motor	187,50 €
Ø60 shaft	SP 7 Nm Wired motor (for roller shutters above 580mm wide)	160,00 €
Ø60 shaft	7 Nm SEE Plus wired motor with obstacle detection - electronic limit switches - (for roller shutters above 670 mm wide)*	145,00 €
Ø60 shaft	10 Nm SEE Plus wired motor with obstacle detection - electronic limit switches*	150,00 €
Ø60 shaft	15 Nm SEE Plus wired motor with obstacle detection - electronic limit switches*	155,00 €
Ø60 shaft	20 Nm SEE Plus wired motor with obstacle detection - electronic limit switches*	162,50 €
Ø60 shaft	30 Nm SEE Plus wired motor with obstacle detection - electronic limit switches*	187,50 €
Ø60 shaft	7 Nm SEE Plus wired motor with obstacle detection (for roller shutters above 550 mm wide)*	175,00 €
Ø60 shaft	7 Nm SEE Plus RC radio motor with obstacle detection (for roller shutters above 660 mm wide)*	200,00 €
Ø60 shaft	10 Nm SEE Plus RC radio motor with obstacle detection*	207,50 €
Ø60 shaft	15 Nm SEE Plus RC radio motor with obstacle detection*	212,50 €
Ø60 shaft	20 Nm SEE Plus RC radio motor with obstacle detection*	220,00 €
Ø60 shaft	30 Nm SEE Plus RC radio motor with obstacle detection*	250,00 €
Ø60 shaft	7 Nm SE Pro wired motor with obstacle detection (for roller shutters above 660 mm wide)	187,50 €
Ø60 shaft	10 Nm SE Pro wired motor with obstacle detection	192,50 €
Ø60 shaft	15 Nm SE Pro wired motor with obstacle detection	200,00 €
Ø60 shaft	20 Nm SE Pro wired motor with obstacle detection	225,00 €
Ø60 shaft	30 Nm SE Pro wired motor with obstacle detection	287,50 €
Ø60 shaft	7 Nm SE Pro wired motor with obstacle detection (for roller shutters above 450 mm wide)	237,50 €
Ø60 shaft	7 Nm SE Pro RC radio motor with obstacle detection (for roller shutters above 660 mm wide)	225,00 €
Ø60 shaft	10 Nm SE Pro RC radio motor with obstacle detection	237,50 €
Ø60 shaft	15 Nm SE Pro RC radio motor with obstacle detection	250,00 €
Ø60 shaft	20 Nm SE Pro RC radio motor with obstacle detection	275,00 €
Ø60 shaft	30 Nm SE Pro RC radio motor with obstacle detection	287,50 €
	1 channel Commeo remote control	87,50 €
	10 channel Commeo remote control	125,00 €
	Commeo Multi 20 channel remote control	212,50 €
	1-channel Commeo mural remote control	97,50 €
	Commeo timer BT (bluetooth) for cable and radio drives	225,00 €

Attention! Our online program offers even more Somfy accessories and solutions.

"IO homecontrol" control

description	Product name	net price
Ø60 shaft	Oximo 50 io 6/17 radio motor, electronic limit switches, obstacle and icing detection (for roller shutters above 770mm wide)*	228,75 €
Ø60 shaft	Oximo 50 io 10/17 radio motor, electronic limit switches, obstacle and icing detection*	253,50 €
Ø60 shaft	Oximo 50 io 15/17 radio motor, electronic limit switches, obstacle and icing detection*	265,25 €
Ø60 shaft	Oximo 50 io 20/17 radio motor, electronic limit switches, obstacle and icing detection*	301,50 €
Ø60 shaft	Oximo S Auto io 6/17 short radio motor, electronic limit switches, obstacle and icing detection (for r.s. above 520mm wide)*	273,00 €
Ø60 shaft	RS100 50 io 6/17 radio motor, electronic limit switches, obstacle and icing detection (for roller shutters above 650mm wide)*	265,25 €
Ø60 shaft	RS100 50 io 10/17 radio motor, electronic limit switches, obstacle and icing detection*	286,00 €
Ø60 shaft	RS100 50 io 15/17 radio motor, electronic limit switches, obstacle and icing detection*	304,25 €
Ø60 shaft	RS100 50 io 20/17 radio motor, electronic limit switches, obstacle and icing detection*	325,00 €
Ø60 shaft	RS100 50 io WT 6/17* radio motor, electronic limit switches, detection of obstacles and icing (for roller shutters from 650 mm width) *control by a push-button switch and a remote control	273,00 €
Ø60 shaft	RS100 50 io WT 10/17* radio motor, electronic limit switches, detection of obstacles and icing *control by a push-button switch and a remote control	293,75 €
Ø60 shaft	RS100 50 io 15/17* radio motor, electronic limit switches, detection of obstacles and icing *control by a push-button switch and a remote control	312,00 €
Ø60 shaft	RS100 50 io 20/17* radio motor, electronic limit switches, detection of obstacles and icing *control by a push-button switch and a remote control	325,00 €
TAHOMA SWITH - online IO & RTS installation manager		374,50 €
Connexoon box IO		286,00 €
Connexoon Window RTS		296,50 €
Set & Go io - starting device for io installations		226,25 €
NiNa Timer remote control - individual and group control and time automatics		299,00 €
NiNa Timer remote control - individual and group control		286,00 €
Situio 1 io Pure remote control		62,50 €
Situio 5 io Pure remote control		96,25 €
Smooove Origin io mural remote control with Pure frame		62,50 €
2 channel Smooove Origin io mural remote control with Pure frame		91,00 €
4 channel Smooove Origin io mural remote control with Pure frame		117,50 €
IZYMO IO radio receiver for roller shutters		166,50 €

RTS cable and radio control

description	Product name	net price
Ø60 shaft	Solus 6 Nm / 12 wired motor (for roller shutters above 650mm wide)	106,50 €
Ø60 shaft	Solus 8 Nm / 12 wired motor	119,50 €
Ø60 shaft	Solus 10 Nm / 12 wired motor	123,50 €
Ø60 shaft	Solus 15 Nm / 12 wired motor	135,25 €
Ø60 shaft	Solus 20 Nm / 12 wired motor	150,75 €
Ø60 shaft	Solus 30 Nm / 12 wired motor	176,75 €
Ø60 shaft	Solus 40 Nm / 12 wired motor	200,50 €
Ø60 shaft	AutoJob SIMU 6Nm / 17 wired motor, electronic limit switches, detection (for roller shutters above 650 mm wide)*	124,75 €
Ø60 shaft	AutoJob SIMU 10Nm / 17 wired motor, electronic limit switches, detection*	134,00 €
Ø60 shaft	AutoJob SIMU 15Nm / 17 wired motor, electronic limit switches, detection*	156,00 €
Ø60 shaft	AutoJob SIMU 6Nm / 17 short motor (for roller shutters above 520mm wide) electric limit switch, detection*	208,00 €
Ø60 shaft	Auto HZ SIMU 8Nm / 17 radio motor, electronic limit switches, detection (for roller shutters above 770 mm wide)*	200,25 €
Ø60 shaft	Auto HZ SIMU 10Nm / 17 radio motor, electronic limit switches, detection*	210,50 €
Ø60 shaft	Auto HZ SIMU 15Nm / 17 radio motor, electronic limit switches, detection*	223,50 €
Ø60 shaft	Auto HZ SIMU 20Nm / 17 radio motor, electronic limit switches, detection*	236,50 €
Ø60 shaft	Auto HZ SIMU 6Nm / 17 short radio motor, electronic limit switches, detection (for roller shutters above 520 mm wide) *	275,50 €
Ø60 shaft	ILMO 50 WT 6 Nm / 17 VVF 2,5M wired motor, electronic limit switches, detection (for roller shutters above 660 mm wide)*	176,75 €
Ø60 shaft	ILMO 50 WT 10Nm / 17 VVF 2,5M wired motor, electronic limit switches, detection*	213,00 €
Ø60 shaft	ILMO 50 WT 15Nm / 17 VVF 2,5M wired motor, electronic limit switches, detection*	215,75 €
Ø60 shaft	ILMO 50 WT 20Nm / 17 VVF 2,5M wired motor, electronic limit switches, detection*	239,25 €
Ø60 shaft	ILMO 50 WT 6 Nm / 17 short wired motor, electronic limit switches, detection (for roller shutters above 520 mm wide)*	241,75 €
Connexoon Window RTS (internet switchboard)		296,50 €

* using of block hangers and stoppers or buffers is necessary

** using of block hangers, stoppers or buffers is not required. They are only necessary if obstacle detection function is to be used.

Attention! Our online program offers even more Somfy accessories and solutions.

RTS cable and radio control

description	Product name	net price
Ø60 shaft	Oximo RTS 6/17 electronic radio motor, obstacle and icing detection** (for roller shutters above 770mm wide)	228,75 €
Ø60 shaft	Oximo RTS 10/17 electronic radio motor, obstacle and icing detection**	254,75 €
Ø60 shaft	Oximo RTS 15/17 electronic radio motor, obstacle and icing detection**	270,40 €
Ø60 shaft	Oximo RTS 20/17 electronic radio motor, obstacle and icing detection**	299,00 €
Ø60 shaft	Oximo RTS 6/17 short motor ** (for roller shutters above 520mm wide)	273,00 €
Ø60 shaft	Altus 50 RTS 6 Nm / 17 motor with built-in radio receiver (for roller shutters above 760mm wide)	241,75 €
Ø60 shaft	Altus 50 RTS 10 Nm / 17 motor with built-in radio receiver	267,75 €
Ø60 shaft	Altus 50 RTS 15 Nm / 17 motor with built-in radio receiver	299,00 €
Ø60 shaft	Altus 50 RTS 25 Nm / 17 motor with built-in radio receiver	325,00 €
Ø60 shaft	Altus 50 RTS 40 Nm / 17 motor with built-in radio receiver	384,75 €
Ø40 shaft	SOLAR drive RTS Autosun SIMU 6/18 (drive + solar panel + battery), detection (from 650 mm width)*	546,00 €
Ø40 shaft	SOLAR drive RTS Autosun SIMU 10/12 (drive + solar panel + battery), detection*	572,00 €
	Power supply for the SIMU solar drive	69,00 €
Ø40 shaft	SOLAR drive RTS Wirefree SOMFY 6/18 (drive + solar panel + battery), detection (from 650 mm width)	676,00 €
Ø40 shaft	SOLAR drive RTS Wirefree SOMFY 10/12 (drive + solar panel + battery), detection (from 650 mm width)	702,00 €
	Power supply for the SOMFY solar drive	96,25 €
Ø60 shaft	Meteor 20/17 NHK motor with emergency opening (for roller shutters above 750mm wide)	286,00 €
Ø60 shaft	Gemini 25/17 NHK motor with emergency opening	299,00 €
Ø60 shaft	Mariner 40/17 NHK motor with emergency opening	338,00 €
Ø60 shaft	Vectran 50/12 NHK motor with emergency opening	364,00 €
Ø60 shaft	Meteor 20/17 NHK RTS radio motor with emergency opening (for roller shutters above 950mm wide)	390,00 €
Ø60 shaft	Apollo 30/17 NHK RTS radio motor with emergency opening	416,00 €
Ø60 shaft	Mariner 40/17 NHK RTS radio motor with emergency opening	434,25 €
Ø60 shaft	Vectran 50/17 NHK RTS radio motor with emergency opening	475,75 €
Ø40 shaft	NL40 4 Nm / 16 VVF 2.5 m wired motor (for roller shutters above 670mm wide)	187,25 €
Ø40 shaft	NL40 9 Nm / 16 VVF 2,5 m wired motor	195,00 €
Ø40 shaft	NL40 13 Nm / 10 VVF 2,5 m wired motor	208,00 €
Ø40 shaft	NL40 4 Nm / 14 short wired motor (for roller shutters above 520mm wide)	208,00 €
Ø40 shaft	ILMO 40 WT 4 Nm / 16 VVF 2,5M wired motor, electronic limit switches, detection *	187,25 €
Ø40 shaft	ILMO 40 WT 9 Nm / 16 VVF 2,5M wired motor, electronic limit switches, detection *	213,25 €
Ø40 shaft	ILMO 40 WT 13 Nm / 10 VVF 2,5M wired motor, electronic limit switches, detection *	221,00 €
Ø40 shaft	Altus 40 RTS 4 Nm / 16 motor with built-in radio receiver	270,50 €
Ø40 shaft	Altus 40 RTS 9 Nm / 16 motor with built-in radio receiver	293,75 €
Ø40 shaft	Altus 40 RTS 13 Nm / 10 motor with built-in radio receiver	309,50 €
	Short coupling + cap SW 60 (for roller shutters above 420mm wide; short drive should be chosen for it)	15,75 €
	Three-position SOMFY Smoove UNO push-button switch without support	28,75 €
	Three-position SOMFY Smoove DUO push-button switch without support, double	39,00 €
	Three-position SOMFY Smoove UNO push-button switch with support	28,75 €
	Three-position SOMFY Smoove DUO push-button switch with support, double	39,00 €
	Smoove Origin RTS Pure mural remote control	57,25 €
	Smoove Origin RTS Pure 4-channel mural remote control	109,25 €
	Centralis UNO RTS receiver (switch with built-in radio receiver)	132,75 €
	Situo 1 RTS pure 1-channel remote control	60,00 €
	Situo 5 RTS pure 5-channel remote control	91,00 €
	Telis 16 RTS pure 16-channel remote control	205,50 €
	Remote control with built-in autotimer Telis 6 Chronis RTS Pure	234,00 €

* using of block hangers and stoppers or buffers is necessary

** using of block hangers, stoppers or buffers is not required. They are only necessary if obstacle detection function is to be used.

radio control MOBILUS

description	Product name	net price
	Wifi switchboard for internet operation of radio drives by smartphone, tablet or computer	190,00 €
Ø40 shaft	10 Nm radio motor (from 731mm roller shutter width)	87,50 €
Ø40 shaft	13 Nm radio motor	115,00 €
Ø60/Ø70 shaft	10 Nm radio motor	110,00 €
Ø60/Ø70 shaft	15 Nm radio motor	110,00 €
Ø60/Ø70 shaft	25 Nm radio motor	115,00 €
Ø60/Ø70 shaft	35 Nm radio motor	150,00 €
Ø40 shaft	ERS radio motor with obstacle detection 10 Nm (from roller shutter width 670 mm)	117,50 €
Ø40 shaft	ERS radio motor with obstacle detection 13 Nm	150,00 €
Ø60/Ø70 shaft	ERS radio motor with obstacle detection 15 Nm (from roller shutter width 720 mm)	142,50 €
Ø60/Ø70 shaft	ERS radio motor with obstacle detection 25 Nm	157,50 €
Ø40 shaft	EP overload motor 10 Nm - obstacle detection - (from roller shutter width 650 mm)*	112,50 €
Ø40 shaft	EP overload motor 13 Nm - obstacle detection*	137,50 €
Ø60/Ø70 shaft	EP overload motor 10 Nm - obstacle detection*	135,00 €
Ø60/Ø70 shaft	EP overload motor 15 Nm - obstacle detection*	137,50 €
Ø60/Ø70 shaft	EP overload motor 25 Nm - obstacle detection*	152,50 €
HM	Cosmo HM1 1-channel remote control	40,00 €
HM3+	COSMO HM3+ 4-channel remote control	42,50 €
G3	COSMO G3 4-channel remote control	52,50 €
HCT	24-channel remote control with COSMO HCT time automatics	165,00 €
HB	COSMO HB 99-channel touch remote control	87,50 €
HM	COSMO HM 99-channel remote control	87,50 €
	Mounting holder for COSMO HM remote controls	10,00 €
L1	COSMO L1 mural 1-channel remote control	45,00 €
L5	COSMO L5 mural 5-channel remote control	52,50 €
WM	COSMO WM mural 1-channel remote control	55,00 €
WT1	WT 1-channel touch mural remote control	82,50 €
WT9	WT 9-channel touch mural remote control	87,50 €
C-MR	COSMO C-MR remote control receiver	55,00 €
C-AR	COSMO C-AR remote control receiver for alarm switchboards	97,50 €
C-GR	COSMO C-GR remote control receiver for 24V garage-doors switchboards	67,50 €
C-SW	Remote-controlled receiver for devices powered up to 3.5 kW	67,50 €
C-SWP	Plug / socket remote-controlled receiver powered up to 3.5 kW	92,50 €
C-ZR	Remote control receiver for COSMO C-ZR facade blinds	75,00 €

* using of block hangers and stoppers or buffers is necessary.

YOODA radio control

description	Product name	net price
	Yooda Smart Control Switchboard	250,00 €
Ø40 shaft	Radio motor 10 Nm (from roller shutter width 750mm)	90,00 €
Ø40 shaft	Radio motor 13 Nm	115,00 €
Ø40 shaft	Short radio motor 10 Nm (from roller shutter width 670mm)	125,00 €
Ø60 shaft	Radio motor 20 Nm	110,00 €
Ø60 shaft	Radio motor 30 Nm	150,00 €
Ø40 shaft	Radio motor with obstacle detection EVY 10 Nm (from roller shutter width 750mm)	117,50 €
Ø40 shaft	Radio motor with obstacle detection EVY 13 Nm	150,00 €
Ø60 shaft	Radio motor with obstacle detection EVY 20 Nm	145,00 €
Ø60 shaft	Radio motor with obstacle detection EVY 30 Nm	175,00 €
Ø60/Ø70 shaft	Radio motor with emergency opening 20 Nm (from 900mm roller shutter width)	185,00 €
Ø60/Ø70 shaft	Radio motor with emergency opening 30 Nm	195,00 €
Ø60/Ø70 shaft	Radio motor with emergency opening 40 Nm	205,00 €
Ø60/Ø70 shaft	Radio motor with emergency opening 50 Nm	210,00 €
Ø60/Ø70 shaft	Radio motor with emergency opening 60 Nm	235,00 €

YOODA radio control

description	Product name	net price
MELODY1	1-channel MELODY remote control	25,00 €
MELODY5	5-channel MELODY remote control	30,00 €
MELODY9	9-channel MELODY remote control	50,00 €
MELODY15	15-channel MELODY remote control	62,50 €
MELODY1P	1-channel MELODY remote control with autotimer	55,00 €
MELODY15P	15-channel MELODY remote control with autotimer	95,00 €
ARTISTIC1	1-channel ARTISTIC remote control	35,00 €
ARTISTIC5	5-channel ARTISTIC remote control	40,00 €
ARTISTIC15	15-channel ARTISTIC remote control	45,00 €
ARTISTIC1P	1-channel ARTISTIC remote control with autotimer	45,00 €
ARTISTIC5P	5-channel ARTISTIC remote control with autotimer	47,50 €
ARTISTIC15P	15-channel ARTISTIC remote control with autotimer	105,00 €
AURORA1	1-channel AURORA OVO remote control	50,00 €
AURORA5	5-channel AURORA OVO remote control	67,50 €
AURORA15	15-channel AURORA OVO remote control	75,00 €
AURORA1P	1-channel AURORA OVO remote control with autotimer	67,50 €
AURORA5P	5-channel AURORA OVO remote control with autotimer	80,00 €
AURORA15P	15-channel AURORA OVO remote control with autotimer	95,00 €
MAGNETICDL1	1-channel MAGNETIC DE LUXE remote control	60,00 €
MAGNETICDL15	15-channel MAGNETIC DE LUXE remote control	92,50 €
MAGNETICDL1P	1-channel MAGNETIC DE LUXE remote control with autotimer	92,50 €
MAGNETICDL5P	15-channel MAGNETIC DE LUXE remote control with autotimer	100,00 €
PIXEL	99-channel PIXEL remote control with autotimer	150,00 €
	PIXEL remote control holder	6,50 €
SHAKKI1	1-channel SHAKKI mural remote control	25,00 €
SHAKKI2	2-channel SHAKKI mural remote control	30,00 €
AURA1	1-channel AURA mural remote control	30,00 €
AURA2	2-channel AURA mural remote control	35,00 €
AURA15	15-channel AURA mural remote control	42,50 €
AURA1P	1-channel AURA mural remote control with autotimer	60,00 €
AURA5P	5-channel AURA mural remote control with autotimer	65,00 €
MAGNETIC1	1-channel MAGNETIC mural remote control	37,50 €
MAGNETIC2	2-channel MAGNETIC mural remote control	40,00 €
MAGNETIC15	15-channel MAGNETIC mural remote control	67,50 €
MAGNETIC1P	1-channel MAGNETIC mural remote control with autotimer	67,50 €
MAGNETIC5P	5-channel MAGNETIC mural remote control with autotimer	75,00 €
SKIDA	1-channel SKIDA pendant remote control	27,50 €
QUATRO	4-channel QUATRO pendant remote control	55,00 €
DC 107	1-channel SHAKKI switchboard, flush-mounted (switch with radio receiver)	55,00 €
DC 111	1-channel AURA switchboard, flush-mounted (switch with radio receiver)	60,00 €
DC 106	2-channel AURA switchboard, flush-mounted (switch with radio receiver)	67,50 €
DC 168	1-channel MAGNETIC switchboard with autotimer, flush-mounted	80,00 €
MIKRO1	1-channel MIKRO flush-mounted switchboard (radio receiver for installation, e.g. in a roller shutter box)	65,00 €
MIKRO2	1-channel MIKRO flush-mounted switchboard with microswitch (radio receiver for installation, e.g. in a roller shutter box)	72,50 €
NANO1	1-channel NANO switchboard (radio receiver for key switch)	57,50 €
NANO2	Bidirectional NANO 1-channel switchboard with overload	75,00 €
GND	Remote controlled electrical socket	50,00 €
WZMS	Signal booster (recommended for large homes, buildings)	85,00 €
	Remote control receiver for alarm switchboards (battery operated)	102,50 €
	Remote control receiver for alarm switchboards (power supply from the alarm switchboard)	87,50 €
SOLEO	SOLEO sun sensor, wireless (for radio drives)	70,00 €
UPS 276	Emergency power supply 276 W UPS with remote control (additional power source in case of a power outage)	325,00 €
UPS 460	Emergency power supply 460 W UPS with remote control (additional power source in case of a power outage)	375,00 €

INEL radio control

description	Product name	net price
Ø40 shaft	Wired motor with obstacle detection 10 Nm, electronic limit switches N-10E (from roller shutter width 700mm)	110,00 €
Ø60 shaft	Wired motor with obstacle detection 20 Nm, electronic limit switches N-10E (from roller shutter width 700mm)	120,00 €
Ø40 shaft	Radio motor 10 Nm (from roller shutter width 720mm)	95,00 €
Ø60 shaft	Radio motor 20 Nm	110,00 €
Ø40 shaft	Radio motor with obstacle detection 10 Nm, electronic limit switches N-10RE	125,00 €
Ø60 shaft	Radio motor with obstacle detection 20 Nm, electronic limit switches N-20RE	150,00 €
Ø40 shaft	Overload motor 10 Nm N-10P (from roller shutter width 700mm)	112,50 €
Ø60 shaft	Overload motor 20 Nm N-20P (from roller shutter width 700mm)	122,50 €
Ø40 shaft	Radio overload motor 10 Nm N-10PR (from roller shutter width 700mm)	120,00 €
Ø60 shaft	Radio overload motor 20 Nm N-20PR (from roller shutter width 700mm)	145,00 €
Ø60/Ø70 shaft	Radio motor with emergency opening 50 Nm (from 900mm roller shutter width)	187,50 €
ST-0P	Controller for roller shutters (for installation with central switch)	47,50 €
ST-01R	Radio receiver (for push-button switch)	55,00 €
ST-01RL	Radio receiver (radio receiver for installation e.g. in a roller shutter box)	55,00 €
PIL-01 PM	1-channel remote control	40,00 €
PIL-05 PM	5-channel remote control	50,00 €
PIL-09 PM	9-channel remote control	57,50 €
PIL-19 PM	19-channel remote control	65,00 €
PIL-19 PMT	19-channel remote control with clock	97,50 €
PIL-99 PMT	99-channel remote control with clock	115,00 €
PIL-02 XB	2-channel pendant remote control	25,00 €
PIL-01 NS	1 channel mural remote control with touch panel	50,00 €
PIL-04 NS	4 channel mural remote control with touch panel	57,50 €
ST-01RN	Switch with a built-in radio receiver	80,00 €

accessories for SK-45 / SP-E / OWAL / SKP roller shutters

Product name	Uom	net price
PP53 standard colour guide	rm	12,75 €
PP53 guide in woodlike colour (varnished)	rm	16,25 €
PP53 guide in woodlike colour (Renolit)	rm	19,50 €
PK53 angled guide standard colour	rm	22,50 €
PK53 angled guide woodlike colour	rm	28,75 €
PPD79 double guide standard colour (for roller shutters set)	rm	25,25 €
PPD79 double guide woodlike colour (for roller shutters set)	rm	31,75 €
20 mm D/PP guide distance, standard colour	rm	12,00 €
20mm D/PP guide distance, woodlike colour (Renolit)	rm	18,00 €
PP53/ODS guide with built-in 12mm off-set, standard colour	rm	27,00 €
PP79/ODS guide with built-in 12mm off-set, standard colour (for sets)	rm	41,50 €
PP53/ODS guide with built-in 20mm off-set, standard colour	rm	30,00 €
PPMO guide, standard colour	rm	24,25 €
PPMO guide, woodlike colour (varnished)	rm	36,00 €
PPDO guide, standard colour (for curtain profile and insect screen)	rm	36,00 €
PPDO guide, woodlike colour (varnished, for curtain profile and insect screen)	rm	38,50 €
PPDO guide, woodlike colour (Renolit, for curtain profile and insect screen)	rm	44,50 €
PP68 standard colour guide	rm	24,25 €
PP68 guide in woodlike colour (varnished)	rm	36,00 €
PP68 guide in woodlike colour (Renolit)	rm	41,75 €
Angle bracket KT 30, standard colour (20 x 30 mm)	rm	10,00 €
PP66 guide, standard colour (for lengths less than 3rm)	rm	32,50 €
PP66 guide, woodlike colour (varnished; for lengths less than 3rm)	rm	35,25 €
PP75 guide, standard colour (for lengths less than 3rm)	rm	32,50 €

accessories for BECLEVER / REVO/ OPOTERM roller shutters

Product name	Uom	net price
PVC guide, white colour	rm	10,00 €
PVC guide, renolit	rm	17,50 €
BeClever ALU guide distance, white colour	rm	20,00 €
BeClever ALU guide distance, one-sided renolit	rm	22,50 €
BeClever ALU guide distance, two-sided renolit	rm	30,00 €
BeClever ALU guide, unwrought	rm	22,50 €
BeClever / Revo mounting anchor	pcs.	0,50 €
Opoterm mounting anchor	pcs.	1,25 €
BeClever / Opoterm reinforcement console	pcs.	32,50 €
Revo reinforcement console	pcs.	57,50 €
Opoterm, BeClever bottom steel box reinforcement	rm	6,00 €
Opoterm, BeClever lateral / frontal steel box reinforcement	rm	3,25 €
Insulating of Opoterm, BeClever, Revo 160/170 box	rm	6,00 €
Insulating of Opoterm, BeClever, Revo 200/210 box	rm	6,75 €
Insulating of Opoterm, BeClever, Revo 240/260 box	rm	8,50 €
NEOPOR Insulating of Opoterm, BeClever, Revo 160/170 box	rm	11,25 €
NEOPOR Insulating of Opoterm, BeClever, Revo 200/210 box	rm	12,50 €
NEOPOR Insulating of Opoterm, BeClever, Revo 240/260 box	rm	15,00 €
Cover plate on BeClever ALU box, RAL painted	rm	60,00 €

profiles and end slats

Product name	Uom	net price
PA39 profile, standard colour	rm / m ²	2,75 € / 60,00 €
PA39 profile, woodlike colour	rm / m ²	3,50 € / 57,50 €
Profile PA 39, woodlike colour, veneered end slat	m ²	75,00 €
PA39 profile, non-standard colour	rm / m ²	4,00 € / 78,75 €
PA43 profile, standard colour	rm / m ²	3,75 € / 75,00 €
PA43 profile, woodlike colour	rm / m ²	4,00 € / 78,75 €
Profile PA 43, woodlike colour, veneered end slat	m ²	86,25 €
PA43 profile, non-standard colour	rm / m ²	4,75 € / 87,50 €
PA 52/55 profile, standard colour	rm / m ²	6,50 € / 100,00 €
PA 52/55 profile, woodlike colour	rm / m ²	7,25 € / 105,50 €
PA77 profile, standard colour	rm / m ²	10,00 € / 133,75 €
PA77 profile, woodlike colour (varnish)	rm / m ²	11,25 € / 151,25 €
End slat, standard colour (for PA39 and PA43)	rm	10,75 €
End slat, woodlike colour (for PA39 and PA43)	rm	17,00 €
End slat, woodlike colour (for PA39 and PA43) + RENOLIT	rm	17,50 €
End slat standard colour (for Pa52)	rm	17,00 €
End slat kolor golden oak (for Pa52)	rm	29,25 €
End slat standard colour (for Pa55)	rm	18,50 €
End slat standard colour (for Pa77)	rm	33,00 €
End slat woodlike colour (for Pa77)	rm	42,00 €

other accessories

Product name	Uom	net price
Side plug of profile 39	pcs.	0,11 €
Side plug of profile 43	pcs.	0,23 €
Side plug of profile 52/55	pcs.	0,30 €
Side plug of profile 77	pcs.	0,43 €
Buffer	pcs.	0,75 €
Box coiler for cord or tape	pcs.	11,50 €
Cranked box coiler for cord / tape + crank	pcs.	42,50 €
Tape for box coiler – white/brown	rm	0,88 €
Tape for box coiler – anthracite / golden oak	rm	1,45 €
White cord for box coiler	rm	0,88 €
Brown cord for box coiler	rm	1,45 €
Cord / tape grommet for SK45 / SP-E / OWAL / SKP	pcs.	2,00 €
Tape grommet for top mounted roller shutter	pcs.	1,45 €
Cord / tape UTL grip	pcs.	3,25 €
SK45, Becliver roller shutter slide	set	2,00 €
Guide stop / bottom plug for the guide	pcs.	0,75 €
Plug of guide Ø10	pcs.	0,15 €
Plug of guide Ø13	pcs.	0,23 €
ACE 1: 7 mechanism to 10 kg	pcs.	49,50 €
ACE 1: 10 mechanism to 24 kg	pcs.	52,50 €
Cardan joint 45° with pivot	pcs.	26,25 €
Cardan joint 90° with pivot	pcs.	43,75 €
Bell grapple for Cardan with pivot	pcs.	18,75 €
Cardan joint 45° with eyelet	pcs.	34,50 €
Cardan joint 90° with eyelet	pcs.	57,50 €
Crank for Cardon joint 150cm	pcs.	51,75 €
Pivot / axle with eyelet	pcs.	17,25 €
Crank with hook 180 cm to NHK drives	pcs.	29,25 €
Crank with hook 150 cm to NHK drives	pcs.	26,50 €
A lock with a key to blind the NHK hole	pcs.	32,25 €
Spring for 10 kg Ø 40	pcs.	47,00 €
Spring for 15 kg Ø 40	pcs.	58,75 €
Spring for 15 kg Ø 60	pcs.	64,50 €
Spring for 24 kg Ø 60	pcs.	67,50 €
Spring for 34 kg Ø 60	pcs.	79,00 €
Cylinder lock	pcs.	47,00 €
Automatic lock (bolt) with no assembly service	set	17,75 €
Manual latch (with no assembly service)	set	9,00 €
Winding wheel	pcs.	6,00 €
Cap Ø 40 for a bearing (SK45, SPE, OWAL, SKP)	pcs.	2,00 €
Cap Ø 40 with steel axle (for top-mounted roller blinds)	pcs.	2,00 €
Cap Ø 60 for a bearing (SK45, SPE, OWAL, SKP)	pcs.	3,00 €
Cap Ø 60 with steel axle (for top-mounted roller blinds)	pcs.	3,00 €
Bearing for cap Ø 40 / Ø 60	pcs.	1,75 €
Cap Ø 60 with steel axle 12mm (for 250mm and bigger SK45 / OWAL boxes)	pcs.	3,75 €
Aluminium cap Ø 70 with steel axle 12mm	pcs.	23,75 €
Cap Ø 70 for inertial brake	pcs.	35,00 €
Cap Ø 60 common drive	pcs.	35,00 €
Ring of pipe / shaft Ø 40	pcs.	0,30 €
Ring of pipe / shaft Ø 60	pcs.	1,30 €
Shaft Ø 40 0,6 mm	rm	5,50 €
Shaft Ø 60 0,6mm	rm	6,75 €
Shaft Ø 60 1 mm	rm	13,75 €
Shaft Ø 70 1,2 mm	rm	23,50 €
Shaft Ø 125	rm	103,75 €
Steel short hanger to PA39 / PA 43	pcs.	1,25 €
Steel long hanger to A39 / PA43	pcs.	1,50 €
Steel hanger to PA52 / PA55 / PA77	pcs.	1,75 €
Block hanger for shaft Ø 40 / Ø 60 (lock to play, 2 parts, complete) to PA39 / PA43 / PA52	set	9,00 €
Ring for block hanger for shaft Ø 40 / Ø 60	pcs.	0,88 €
Block hanger for shaft Ø 60 / Ø 70 (3 parts, complete) to PA55	pcs.	16,25 €
Block hanger for shaft Ø 60 / Ø 70 (4 parts, complete, round ring) to PA55 / PA77	pcs.	19,25 €
Asymmetric ring for shaft Ø 70 to PA77	pcs.	6,25 €
Onduterm XL insulation mat (3 mm thick, 205 mm wide, additional thermal conductivity (0.56 (m ² K) / W)	rm	6,25 €

services

Name	Uom	net price
Drilling the holes in guides (free, on customer's request)	rm	0,00 €
Cable extraction from the SK45, OWAL, SP-e, SKP box (free, on customer's request)	rm	0,00 €
Packing in corrugated cardboard	rm	3,75 €
Packing in a 6 mm cardboard (applies to boxes; guides in bubble wrap)	rm	15,00 €
Courtain profile and roller shutter box separately packing (when ordering complete roller shutter)	rm	10,00 €
Varnishing the box to RAL colour	pcs.	32,50 €
Varnishing the revision flap to RAL colour	pcs.	26,25 €
Varnishing the guides to RAL colour	set	20,00 €
Varnishing the guides distance to RAL colour	set	14,50 €
Varnishing the end slat to RAL colour	pcs.	12,50 €
Narrowing the external roller shutter of the Fart Produkt company	pcs.	35,00 €
Narrowing the courtain profile of the Fart Produkt company	pcs.	20,00 €
Narrowing the external roller shutter of the other company	pcs.	80,00 €
Narrowing the courtain profile of the other company	pcs.	42,50 €
Milling the end slat to cylinder lock	pcs.	17,50 €
Mounting of an automatic lock (bolt) or manual latch	pcs.	12,50 €
Mounting the cranked mechanism for lifting the roller shutters with Cardan joint (roller shutter up to 10 kg)	set	135,00 €
Mounting the cranked mechanism for lifting the roller shutters with Cardan joint (roller shutter up to 24 kg)	set	145,00 €

To correctly select the drive, the area of the roller shutter needs to be calculated in m², and the obtained result be multiplied by the weight of the curtain profile:

- Pa39 – 2,8 kg.
- Pa43 – 2,6 kg.
- Pa52 – 3,0 kg.
- Pa55 – 3,5 kg.
- Pa77 – 4,8 kg.

To the obtained result, 10% needs to be added and appropriate drive can be selected from the table, paying attention to the height of the roller shutter and the size of the shaft.

Example:

1. For roller shutters made of Pa39 mm profile with dimensions of 2000mm x 2000mm, the area needs to be calculated: 2 m x 2 m = 4 m², so the area of the roller shutter is 4 m².
2. The obtained result is multiplied by the weight of Pa39: 4m² x 2.80 = 11.2 kg. We add 10%: 11.2 + 10% = 12.32 kg.
3. With a weight of 12.32 kg, a 10Nm drive can be used (with a standard cable drive), but the table with roller shutter prices shows, that with this size of roller shutter, the ø60 shaft needs to be applied, so a 20Nm drive must be used.

type of drive	name of drive	minimum widths of roller shutters	type of drive	shaft	power	maximum lifting capacity [kg] depending on height				
						1,5 m	2,5 m	3 m	4 m	
cable	cable motor standard	width from 480 to 549 mm	short	Ø 60	10Nm	17	15	14		
		width from 550 to 620 mm	short	Ø 40	10Nm	19	17	16		
		from 621 mm width		Ø 40	10Nm	19	17	16		
				Ø 60	20Nm	34	34	31	28	
				Ø 60	40Nm	65	62	58	55	
	Selve SP	width from 580 to 669 mm			Ø 60	7Nm	17	13	11	
		minimum width 670 mm			Ø 60	10Nm	23	18	15	
					Ø 60	15Nm	33	27	24	
					Ø 60	20Nm	43	35	31	23
					Ø 60	30Nm	63	52	47	39
	Somfy Solus	minimum width 650 mm			Ø 60	6Nm	12	8	6	
					Ø 60	10Nm	22	18	15	
					Ø 60	15Nm	34	29	24	
					Ø 60	20Nm	44	34	30	20
					Ø 60	30Nm	65	50	40	32
	Somfy NL40	width from 550 to 669 mm	short		Ø 40	4Nm	10	8	6	
		from 670 mm width			Ø 40	4Nm	22	18	15	
					Ø 40	9Nm	34	29	24	
					Ø 40	13Nm	10	8	6	
	cable NHK standard	minimum width 800 mm			Ø 60	20Nm	34	34	31	28
				Ø 60	50Nm	75	72	69	50	
cable with NHK	Somfy NHK	minimum width 750 mm		Ø 60	20Nm	45	38	30	22	
				Ø 60	25Nm	56	47	37	30	
				Ø 60	40Nm	90	80	70	55	
				Ø 60	50Nm	99	86	72	62	
radio motor	Mobilus	minimum width 731 mm		Ø 40	10Nm	17	15	12		
				Ø 60	15Nm	28	24	20		
				Ø 60	25Nm	48	38	33	25	
				Ø 60	35Nm	70	60	50	35	
	Inel	minimum width 720 mm		Ø 40	10Nm	18	16	15		
				Ø 60	20Nm	38	34	30	22	
	Somfy Altus RTS	minimum width 760 mm			Ø 60	6Nm	12	8	6	
					Ø 60	10Nm	22	17	15	
					Ø 60	25Nm	44	34	30	20
					Ø 60	40Nm	85	66	60	50
	Yooda	width from 670 to 749 mm	short		Ø 40	10Nm	19	17	16	
		minimum width 750 mm			Ø 40	10Nm	19	17	16	
				Ø 60	20Nm	34	30	27	20	
				Ø 60	30Nm	50	43	40	30	
radio with NKH	Inel NHK	minimum width 900 mm			Ø 60	50Nm	75	72	69	50
	Yooda NHK	minimum width 900 mm			Ø 60	20Nm	34	34	31	28
					Ø 60	30Nm	50	44	40	30
					Ø 60	40Nm	70	65	60	55
					Ø 60	50Nm	75	72	69	50

type of drive	name of drive	minimum widths of roller shutters	type of drive	shaft	power	maximum lifting capacity [kg] depending on height			
						1,5 m	2,5 m	3 m	4 m
radio with NHK	Somfy NHK	minimum width 950 mm		∅ 60	20Nm	45	38	30	22
				∅ 60	30Nm	60	50	40	33
				∅ 60	40Nm	90	80	70	55
				∅ 60	50Nm	99	86	72	62
cable with detection	Simu Autojob	width from 520 to 649 mm	short	∅ 60	6Nm	12	8	6	
		minimum width 650 mm		∅ 60	6Nm	12	8	6	
				∅ 60	10Nm	22	18	15	
				∅ 60	15Nm	34	29	24	17
	Inel E	minimum width 700 mm		∅ 40	10Nm	19	17	16	
		minimum width 700 mm		∅ 60	20Nm	34	34	31	23
	Somfy ILMO WT	width from 520 to 659mm	short	∅ 60	6Nm	12	8	6	
		minimum width 660 mm		∅ 60	6Nm	12	8	6	
				∅ 60	10Nm	22	17	15	
				∅ 60	15Nm	34	27	24	17
	Selve SEE Plus	minimum width 670 mm		∅ 60	7Nm	17	13	11	
				∅ 60	10Nm	23	18	15	
				∅ 60	15Nm	33	27	24	
				∅ 60	20Nm	43	35	31	23
				∅ 60	30Nm	63	52	47	38
	radio with detection	ERS Mobilus	minimum width 670 mm		∅ 40	10Nm	17	15	12
				∅ 60	15Nm	28	24	20	
				∅ 60	25Nm	48	38	33	25
Yooda EVY		minimum width 750mm		∅ 40	10Nm	19	17	16	
				∅ 60	20Nm	34	30	27	20
				∅ 60	30Nm	50	43	40	34
Simu Auto Hz		width from 520 to 769 mm	short	∅ 60	6Nm	12	10	8	
		minimum width 770 mm		∅ 60	8Nm	16	14	12	
				∅ 60	10Nm	20	18	16	
				∅ 60	15Nm	30	27	23	
				∅ 60	20Nm	34	30	26	18
Somfy Oximo IO		width from 520 to 769 mm	short	∅ 60	6Nm	12	8	6	
		minimum width 770 mm		∅ 60	6Nm	12	8	6	
				∅ 60	10Nm	22	17	15	
				∅ 60	15Nm	34	27	24	
				∅ 60	20Nm	44	34	30	20
Somfy Oximo RTS	width from 520 to 769 mm	krótki	∅ 60	6Nm	12	8	6		
	minimum width 770 mm		∅ 60	6Nm	12	8	6		
			∅ 60	10Nm	22	17	15		
			∅ 60	15Nm	34	27	24		
			∅ 60	20Nm	44	34	30	20	
Selve SEE Plus RC	minimum width 770 mm		∅ 60	7Nm	17	13	11		
			∅ 60	10Nm	23	18	15		
			∅ 60	15Nm	33	27	24		
			∅ 60	20Nm	43	35	31	23	
			∅ 60	30Nm	63	52	47	38	

All data for the order must be included in the order form, we do not take responsibility for additional comments contained in any other form than the order form, unless the information in the "comments" field indicates that the instructions for making roller shutters are provided elsewhere.

1. Symbol of the selected profile Pa39, Pa43 or Pa52.

2. The colour symbol given in the price list, e.g. if there is to be a walnut, should be entered: 28, if gray anthracite: 23. If armor-plating without perforation is to be used, then the number 1 should be added to the colour symbol, i.e. walnut, : 128, white: 102 etc.

When there is selected control by spring + lock, we always use unperforated armor-plating. If the symbol is entered incorrectly, e.g. instead of 128 it is 28, we will correct it for 128, without informing about this fact and assuming it is a mistake. If perforated armor-plating with this control is necessary to be used, please make a note about that in comments.

3. Mark the field with "x" if a mosquito net is to be used. The net is gray, the end slats of the mosquito net are available in the following colours: 01, 02, 03, 05, 08, 09, 15, 22, 23, 26R, 28, 28R, 30, 30R.

4. The total width of the roller shutter in millimeters along with the guides. The width of the guides needs to be added to the measured hole dimension; PP53: 53mm, PP66: 66mm, PP68: 68mm, PP75: 75mm.

In case of two roller shutters set, specify each roller shutter from the set separately in subsequent positions. If the roller shutters in the set have the same height, a joint guide (PPD79) will be used to connect the roller shutters, and the width of the roller shutter will be treated as a dimension to the axis of the guide.

5. Total height of the roller shutter in millimeters along with the box. By installing the roller shutter outside the measured opening, the height of the applied box to the height of roller shutter needs to be added.

6. Number of roller shutters: If the set consists of several roller shutters in one box, each part of the set in a separate line needs to be entered, and write in the notes that e.g. items No. 3 and 4 form the set. It can also an auxiliary drawing be drawn. In case of lack of set-sides information, it is assumed that the first given dimension is the left part of the set looking from the inside and the second dimension is the right part of the set looking from the inside.

7. The height / size of the box in millimeters, selected in accordance with the table in price list. For increasing the size of the box compared to the prices table there is no additional charge. If the size of the box is not entered, it will be selected according to the table.

8. The colour of the box: Enter the colour symbol or RAL number (if it is to be varnished). If the colour is not specified, the box in the colour of the selected armor-plating will be applied (if such colour is available). If the box is to be in veneer, and it is available in a varnished and veneer version, then the letter "R" needs to be written into the colour number (e.g. 28R), and if it is available only in veneer, there is no need to add "R".

9. End slat colour: Enter the colour symbol or RAL number (if it is to be

varnished). If the colour is not specified, the end slat in the colour of the selected armor-plating will be applied (if such colour is available). If the end slat is to be veneer, and it is available in a varnished and veneer version, then the letter "R" needs to be written into the colour number (e.g. 28R), and if it is available only in veneer, there is no need to add "R".

10. Guide type: write the guide symbol in: PP53 (standard, straight), PK53 (angled), PPMO (which pull the armor-plating apart from the window, used to place e.g. pleated mosquito net between roller shutter and window), PP68 (widened), PP66 (standard for Pa52), PP75 (for large 250mm boxes). In roller shutters with mosquito nets there are no joint-guides available, only single PP.

11. Guides colour: Enter the colour symbol or RAL number (if it is to be varnished). If the colour is not specified, the guides in the colour of the selected armor-plating will be applied (if such colour is available). If the guides are to be veneer, and they are available in a varnished and veneer version, then the letter "R" needs to be written into the colour number (e.g. 28R), and if they are available only in veneer, there is no need to add "R". Veneered guides are available only with one-sided veneer - from the outside.

12. Drive type, X in the appropriate column:

- cord - will be used a box coiler for cord in white, the grommet will be in the same color, if it is to be applied in brown, this should be entered in the comments.
- tape - will be used a box coiler for tape in white, the grommet will be in the same color, if it is to be applied in brown or anthracite, this should be entered in the comment.
- for an extra charge, a tape / cord holder can be applied.
- cranked box coiler - we use white as standard, in the version for the cord it occurs in white, in the version for the tape in anthracite or brown; in addition to marking of this field, mark the selected option "cord" or "tape" as well.
- spring - always comes complete with a cylinder lock, marking of this field will mean that a cylinder lock is also to be applied and if the screws securing side is not specified, we assume it will be standard, i.e. the screws will be secured and invisible from the revision flap side.
- motor type - provide the motor type and producer's name, for standard cable motors, we use the ones we currently have on stock.
- control - provide additional equipment, according to the legend: P-5 - means 5-channel remote control, WKp - flush-mounted push-button switch, etc.
- control of the Cardan mechanism should be entered in the notes, with this control any of the fields "drive type" should not be selected.

13. Protection method against lifting - mark the appropriate field.

- latch and automatic bolt - used for roller shutters controlled by a cord or tape.
- lock - used with spring-controlled roller shutters, it can also be applied with a cord or tape.

- block hanger - used with electric roller shutters, are also required with some drives with obstacle detection.

14. Control side - the extraction side of the control cable, tape or drive cable, viewing from inside the room.

15. Control extraction location - cable or tape control extraction location, as shown in the drawing: A, B, C or D.

- Marking this field in SK45/ OWAL/ SKP roller shutter with drive, means the place where the cable is led out, no marking will cause the cable remaining in the box, for self-ledding out.
- in the SP-e roller shutter, we lead the cable out of the side of the box as standard; if it is to be in another place, it should be properly indicated.

16. Mounting type - fill in according to drawing A, B or C.

- A - mounting on the elevation.
- B - mounting in a niche.
- C - mounting the box inverted.

17. Inscribing the appropriate letter will mean the drilling of the guides, entering "x" will mean standard drilling (type B).



Order form for external facade roller shutters in boxes: 45°.

* before completing the order form, please familiarise yourself with explanations and general sale conditions.

Fart Produkt Ltd. Limited partnership, Towarowa street 3, 87-100 Toruń,
+48 56 623 55 77, www.fartprodukt.pl, export@fartprodukt.pl.

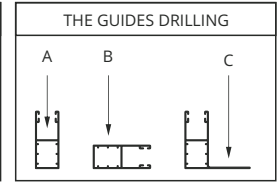
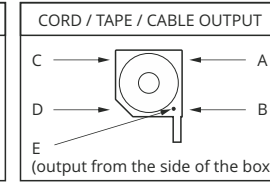
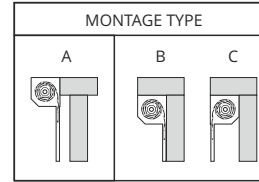

Ordinal	Curtain profile type [39, 43, 52]	Curtain profile colour	Mosquito net	Roller shutter dimensions [mm] (with box and guides)		Quantity [pcs.]	Box size (mm)	Box colour	End slat colour	Guides type PP straight PK angled [PK / PP] [PPMO] [P68]	Bottom end cap of the PP53 guide	Guides colour	Drive type					Protection method against lifting				Control side (sight from within) [L / R]	Output cord / tape / cable	Montage type	The guides drilling														
				width	height								Manual					Electric		manual latch	auto-matic bolt					cylinder lock	block hanger												
													cord (up to 12 kg)	tape (up to 12 kg)	cranked box/coiler (up to 20 kg)	spring	Motor type*	Control**																					
1	2	3	4	5	6	7	8	9	10		11	12					13				14	15	16	17															

FILLS IN THE CUSTOMER:

Customer's stamp and signature	* motors types CM - cable motor RM - radio motor OM - overload motor ROM - radio overload motor MEO - motor with emergency opening	** electric control PBp - push-button switch p/t PBn - push-button switch n/t PBR - radio push-button switch P - X - x-channel remote control PK - key switch	notes / drawings from within
	Order no.	Order date	

All data for the order must be included in the order form, we do not take responsibility for additional comments contained in any other form than the order form, unless the information in the "comments" field indicates that the instructions for making roller shutters are provided elsewhere.

1. Symbol of the selected profile Pa39, Pa43.

2. The colour symbol given in the price list, e.g. if there is to be a walnut, should be entered: 28, if gray anthracite: 23. If armor-plating without perforation is to be used, then the number 1 should be added to the colour symbol, i.e. walnut ; 128, white: 102 etc.

When there is selected control by spring + lock, we always use unperforated armor-plating. If the symbol is entered incorrectly, e.g. instead of 128 it is 28, we will correct it for 128, without informing about this fact and assuming it is a mistake. If perforated armor-plating with this control is necessary to be used, please make a note about that in comments.

3. Mark the field with "x" if a mosquito net is to be used. The net is gray, the end slats are not available in all woodlike colours, the availability needs to be checked.

4. Mounting type - fill in according to drawing A, B or C

- A - box from the outside and inside with no building in, smooth, without angle brackets.
- B - box from the outside intended for building in (with angle bracket), inside without building in (smooth).
- C - box built in on both sides, angle brackets on both sides of the box
- no marking of montage type means standard version, i.e. type C
- the outer angle bracket occurs in white and brown, by light colours of armor-plating applies white, and by dark colours - brown

5. Total width of the roller shutter in millimeters: with these roller shutter systems and with standard montage, the width of the roller shutter with guides = window width. In case of two roller shutters set, specify each roller shutter from the set separately in subsequent positions.

If the roller shutters in the set have the same height, a joint guide (60mm) will be used to connect the roller shutters, and the width of the roller shutter will be treated as a dimension to the axis of the guide.

In case of three roller shutters set with the same height, there is no possibility to use a joint guide to connect them, every roller shutter from the set will have a separate guides, so on connection of roller shutters in the set, the total width of the guides will be 120 mm.

6. The total height of the roller shutter in millimeters, including the box. To the window height, the height of the box given in the price list table should be added.

7. The height / size of the box in millimeters, selected in accordance with the table in price list. For increasing the size of the box compared to the prices table there is no additional charge. If the size of the box is not entered, it will be

selected according to the table.

8. The colour of the box: Enter the colour symbol or RAL number (if it is to be varnished). If the colour is not specified, the box in the colour of the selected armor-plating will be applied (if such colour is available). If the box is to be in veneer, and it is available in a varnished and veneer version, then the letter "R" needs to be written into the colour number (e.g. 28R), and if it is available only in veneer, there is no need to add "R".

9. End slat colour: Enter the colour symbol or RAL number (if it is to be varnished). If the colour is not specified, the end slat in the colour of the selected armor-plating will be applied (if such colour is available). If the end slat is to be veneer, and it is available in a varnished and veneer version, then the letter "R" needs to be written into the colour number (e.g. 28R), and if it is available only in veneer, there is no need to add "R".

10. Box colour:

- front profile from without, if montage type C is selected - leave the field empty, if type A or B is selected, please write in the symbol or name of the box colour.
- front profile from within, if montage type C or B is selected - leave the field empty, if type A is selected, please write in the symbol or name of the box colour.
- revision flap - write in the symbol or name of the colour, leaving the field empty means that the colour should be standard, i.e. white.

11. Guide colour, enter the symbol or name of the guide colour, if the guide is to be aluminum, provide the RAL number on which it is to be varnished. As standard are used "H" cross-section guides, if single-chamber guides are to be used (additional payment), please point it out. Single-chamber guides have veneer only on one plane, from without. There is a possibility to plaster the side plane of the guide for an extra charge (longer period of implementation).

12. Drive type, X in the appropriate column:

- tape - a white box coiler for tape will be used, only in the case of choosing the dark revision flap we'll use a brown or anthracite, for an extra charge a tape holder may be used.
- cranked box coiler - we use white as standard, only in the case of choosing the dark revision flap we'll use a brown or anthracite.
- motor type - write in the motor type and producer's name, for standard cable motors, we apply the ones we currently have on stock.
- control - enter the additional equipment, according to the legend: P-5 - means 5-channel remote control, WKp - flush-mounted key switch, etc.
- control by the Cardan mechanism should be written in the comments, by this control do not select any of the "drive type" fields.

13. Protection method against lifting - mark the appropriate field:

- automatic bolt - used for roller shutters controlled by a cord or tape.

- block hanger - used with electric roller shutters, are also required with some drives with obstacle detection.

14. Control side - the extraction side of the control tape or drive cable, viewing from inside the room.

15. Only available in Revo and Opoterm roller shutters - the type of adapter used to connect the window with the roller shutter must be specified or the accurate name of the window profile and its thickness must be provided.



Order form for REVO roller shutters.

* before completing the order form, please familiarise yourself with explanations and general sale conditions.

Fart Produkt Ltd. Limited partnership, Towarowa street 3, 87-100 Toruń,
+48 56 623 55 77, www.fartprodukt.pl, export@fartprodukt.pl.

MONTAGE TYPE:



A - without building in



B - with building in from the inside



C - with complete building in

Ordinal	Cortain profile type [39, 43]	Cortain profile colour	Mosquito net	Montage type	Roller shutter dimensions [mm] (with box and guides)		Quantity [pcs.]	Box size (mm)	End slat colour	Box colour			Guides colour	Drive type				Protection method against lifting		Control side (sight from within) [L / R]	Adaptive profile type
					Frontal profiles					Revision flap colour	Manual			Electric		Automatic bolt	Block hanger				
					external	internal					Cord (up to 12 kg)	Cranked box coiler (up to 20 kg)		Motor type*	Control**						
5	6	7	8	9	10	11	12	13	14	15											

Adaptive profiles types:

FLAT

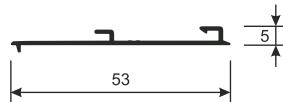

UNIVERSAL (white or brown)

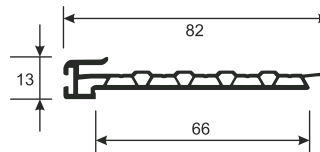

6 mm

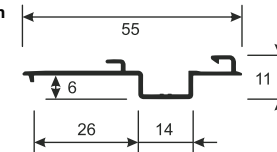

8 mm

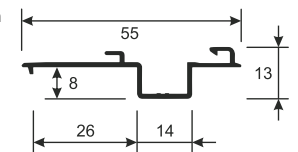

FILLS IN THE CUSTOMER:

Customer's stamp and signature	<p>* motors types CM - cable motor RM - radio motor OM - overload motor ROM - radio overload motor MEO - motor with emergency opening</p>	<p>** electric control PBp - push-button switch p/t PBn - push-button switch n/t PBR - radio push-button switch P - X - x-channel remote control PK - key switch</p>	<p>notes / drawings from within</p>
	Order no.	Order date	



Order form for OPOTERM roller shutters.

* before completing the order form, please familiarise yourself with explanations and general sale conditions.

Fart Produkt Ltd. Limited partnership, Towarowa street 3, 87-100 Toruń,
+48 56 623 55 77, www.fartprodukt.pl, export@fartprodukt.pl.

MONTAGE TYPE:



A – without building in



B – with building in from the inside



C – with complete building in

Ordinal	Curtain profile type [39, 43]	Curtain profile colour	Mosquito net	Montage type	Roller shutter dimensions [mm] (with box and guides)		Quantity [pcs.]	Box size (mm)	End slat colour	Box colour			Guides colour	Drive type				Protection method against lifting		Control side (sight from within) [L / R]	Adaptive profile type
					Frontal profiles					Revision flap colour	Manual			Electric		Automatic bolt	Block hanger				
					external	internal					Cord (up to 12 kg)	Cranked box coiler (up to 20 kg)		Motor type*	Control**						
5	6	7	8	9	10	11	12	13	14	15											

Adaptive profiles types:

PSAW/6,7/x

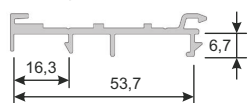

PSAW/6,8/x

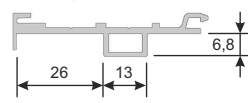

PSAW/7/x

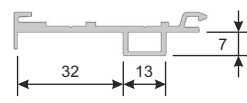

PSAW/7,9/x

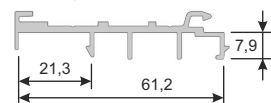

PSAW/8/x

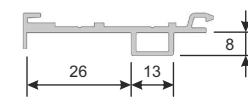

PSAW/8/2/x

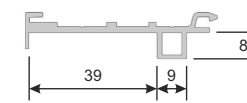

FILLS IN THE CUSTOMER:

Customer's stamp and signature	* motors types CM – cable motor RM – radio motor OM – overload motor ROM – radio overload motor MEO – motor with emergency opening	** electric control PBp – push-button switch p/t PBn – push-button switch n/t PBR – radio push-button switch P – X – x-channel remote control PK – key switch	notes / drawings from within
	Order no.	Order date	

All rights reserved.

The property rights to texts, drawings, photos and all other information published in this price list belong to Fart Produkt Ltd. limited partnership, Towarowa street 3, 87-100 Toruń. It is forbidden to use, duplicate, distribute or modify the submitted graphic materials in a manner other than specified in the contract with Fart Produkt Ltd. limited partnership, Towarowa street 3, 87-100 Toruń. Fart Produkt Ltd. limited partnership, Towarowa street 3, 87-100 Toruń reserves the right to withdraw consent to the use, reproduction, distribution or modification of received graphic materials.

Fart Produkt Ltd. Limited partnership,
Towarowa street 3, 87-100 Toruń

Towarowa street 3
87 - 100 Toruń
tel. + 48 56 623 55 77
www.fartprodukt.pl
e-mail: export@fartprodukt.pl

