



## Price list of external jalousies



edition 15.05.2023

## Price list of external jalousies

\ 1	Products description
\ 2 – 13	Price list for <b>BOX Premium</b> facade jalousies
\ 14– 19	Price list for <b>Classic</b> facade jalousies
\ 20 – 24	Price list for <b>BeClever</b> facade top-mounted jalousies
\ 25	Colour scheme
\ 26	Electric control – remote controls and accessories
\ 27 – 29	Order forms
\ 30	General sale conditions

## Aesthetics and functionality

Facade (external) jalousies are a modern and elegant window cover mounted on the outside of the building facade.

The light and simple design will fit perfectly in single-family housing as well as in modern architectural buildings with large glazing.

The Fart Produkt facade jalousies protect the interior of the building from excessive sunlight, and, thanks to its aesthetic value, affect its external appearance, often being an element complementing the aesthetic design of the facade.

Mounted on large facades, they act as an insulator that affects the proper temperature distribution in the room and helps the air conditioning work - without overloading it. Between the slats surface and the glass there is a thermal barrier created, i.e. a mass of air, which slows down the heat transfer. Thanks to this, at a temperature of 35 °C outside, you can lower the temperature inside the building by even up to 10 °C.

The slats can be raised and lowered, as well as their pitch can be changed. This allows to regulate the access of light and heat inside the room.

The height of the folded slats package in the pulled-up position varies depending on the type of jalousie and its height. This size is important from the point of view of the architectural design, because usually it is necessary to leave enough space above the window to fit the entire package of slats.

A wide range of colors allows you to perfectly adapt the jalousie to both modern as well as traditional architectural objects.

### Properties of Fart Produkt facade jalousies:

- an effective way to protect interiors against solar radiation and noise,
- smooth regulation of daylight access inside the room,
- resistance to weather conditions activity and a very long product life,
- variety of structural solutions,
- large range of colours,
- elegant element of the building facade,
- light and simple aluminum structure, which does not overload the building facade,
- automation of the jalousies work in cooperation with the weather automation system.



### Case BOX Premium.

Made of 1,2 mm thick aluminum, BOX Premium case can be surface- or flush-mounted. Depending on the chosen method of installation, as well as the variant of the brackets configuration, it gives the possibility of applying additional insulation at the back and an additional plaster carrier at the front.

### Haberdashery.

The textile tape is made of special fibers with the addition of Kevlar, ensuring high toughness, abrasion resistance and colour durability.

The ladder is made of polyester and is available in gray or black.

### Bottom gutter.

Extruded aluminum profile with a width adapted to the type of slat, powder coated with high-quality varnishes resistant to weather conditions. The bottom gutter is finished with plastic plugs.

### Bottom gutter end cap.

Gutter side end cap is made of plastic, available in gray and black. The end cap has the bottom gutter guide pin bolt.

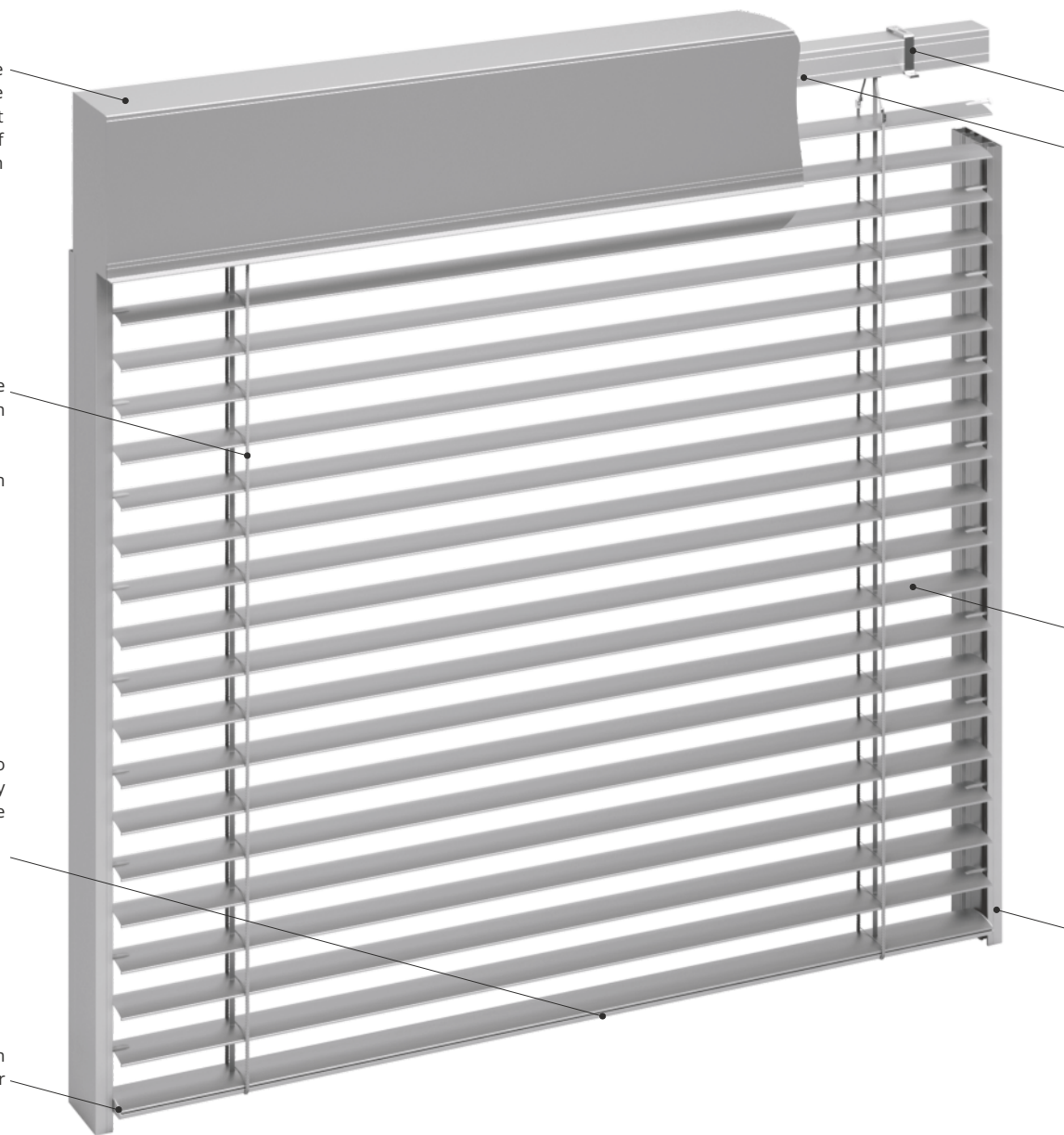

### Upper gutter mounting bracket.

Upper gutter mounting brackets are made of galvanized steel.

### Upper gutter.

56 x 58 mm cold-rolled U-shaped profile is made of heat-galvanized 0.6 mm thick steel sheet. The upper gutter is open downwards for easy service access.

### Control.

Automatic control of the jalousies using an electric motor with a voltage of 230 V / 50 Hz and an active power from 90 to 210 W.

### Slats.

A horizontal aluminum slat, approx. 0.4 mm thick and 80 or 93 mm wide, shaped in the rolling process, is covered with high-quality varnishes resistant to weather conditions.

### Side guidance.

Side guidance with 88.4 mm wide guides. With the use of additional insulation, the guide is lengthened with a special adaptor.



### SLATS PACKAGE

- 80 mm wide aluminum slat, painted with resistant to weather conditions varnish.
- as standard slat rotation 90°; 180° rotation for an additional charge of 5%.
- bottom gutter with dimensions of 80 x 13 mm.
- a textile tape made of special fibers with the addition of Kevlar.
- a package of jalousie as standard fixed with automatic brackets of the top rail mounting.
- maximum jalousie dimensions: width: 4000 mm, height: 3200 mm, surface area according to the table.

### GUIDANCE THE SLAT

- guides made of aluminum, 88,4 mm wide, fixed to the window or window recess.

### CASSETTE

- cassette made of 1.2 mm thick aluminum is available in four heights - H = 200/240/300/350 mm.
- as standard (no extra charge) it is possible to use 10 mm brackets, 20 and 40 mm brackets are available for an extra charge

### DRIVE

- drives for an extra charge, table on page 26.
- depending of the size of the jalousie the appropriate drive power needs to be selected.

### CASSETTES

- Variant 1 and 2** - without cassette building in, surface mounting.
- Variant 2** - 10mm bracket on the back side of the cassette.

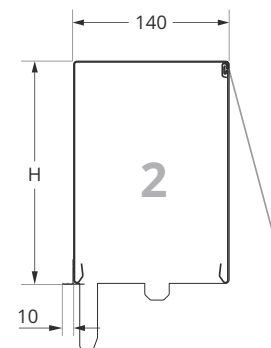
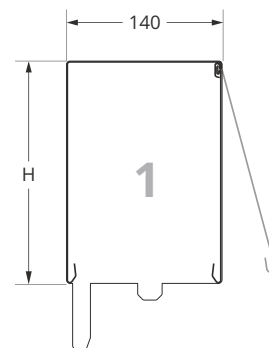

### SLAT

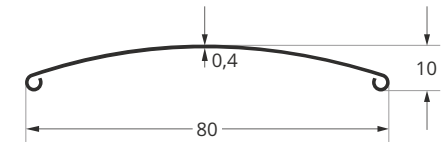

### BOX PREMIUM GUIDE

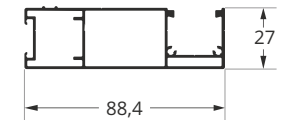

### OFF-SETS OF THE GUIDE

(used with brackets)

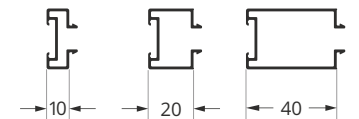

### BRACKETS

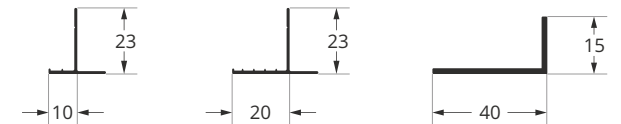

**Variants 3 and 4** - cassette for building in.

**Variant 3** - 10 mm bracket on the front side of the cassette.

**Variant 4** - 10 mm bracket on the back and front sides of the cassette.

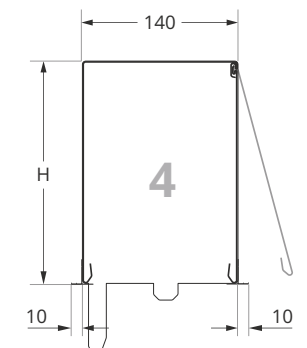
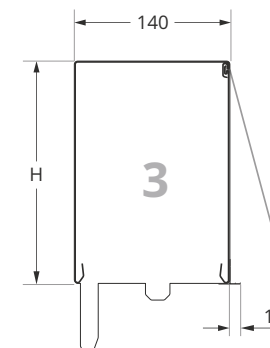

C80 BOX PREMIUM facade jalousies																			Net prices in Euro, dimensions in mm				
height of cassette	total height of jalousie	width																	surcharge for guides in RAL colour (2 pcs)	Side guide 10 mm off-set (2 pcs)	Side guide 20 mm off-set (2 pcs)	Side guide 40 mm off-set (2 pcs)	
		800	900	1000	1100	1200	1300	1400	1500	1600	1700	1800	1900	2000	2100	2200	2300	2400					
200	800	192	204	216	228	240	261	274	296	319	332	345	357	371	383	396	409	422	14,8	9,5	11,3	13,3	
	900	199	212	225	237	249	271	284	306	330	343	356	369	382	395	408	421	434	16,8	10,8	12,3	15,0	
240	1000	207	220	233	246	258	279	293	316	339	353	366	379	393	406	419	433	446	18,5	12,3	13,5	16,8	
	1100	215	228	241	254	267	289	302	325	349	363	377	390	404	418	431	445	459	20,3	13,3	15,0	18,5	
	1200	223	236	249	263	276	298	312	336	360	374	388	401	415	429	443	457	471	22,0	14,5	16,5	20,0	
	1300	231	245	258	272	285	307	321	346	370	384	398	412	427	441	455	469	483	24,0	15,8	18,0	21,8	
	1400	239	253	266	280	294	316	331	355	380	394	409	423	437	452	467	481	495	25,8	17,0	19,3	23,5	
	1500	247	261	275	289	303	325	340	365	390	405	419	434	449	463	478	493	507	27,5	18,3	20,3	25,3	
	1600	255	269	283	297	312	334	349	375	401	415	430	445	460	475	490	505	520	29,5	19,3	21,8	27,0	
	1700	268	284	299	314	330	353	369	396	422	438	454	470	486	502	518	533	550	31,3	20,8	23,3	28,5	
300	1800	277	292	307	323	339	363	379	406	433	449	465	481	498	514	529	546	562	33,3	21,8	24,8	30,5	
	1900	285	300	316	332	347	372	388	416	443	460	476	492	508	525	541	558	574	35,0	23,0	26,0	32,0	
	2000	292	308	324	340	356	381	397	426	453	469	486	503	520	536	553	570	586	37,0	24,3	27,5	33,5	
	2100	300	316	333	349	365	390	407	436	463	480	497	514	531	548	565	582	598	38,8	25,5	28,5	35,0	
	2200	308	324	341	357	374	399	416	446	474	490	508	525	542	559	577	593	611	40,5	26,5	30,3	37,0	
	2300	316	333	349	366	383	408	426	456	484	501	518	536	553	570	588	605	623	42,5	27,8	31,5	38,5	
350	2400	324	340	358	375	392	418	435	466	494	511	529	547	565	582	600	618	635	44,3	29,0	32,8	40,3	
	2500	331	349	366	384	401	427	445	476	504	522	540	558	576	593	612	630	648	46,0	30,5	34,3	41,8	
	2600	339	357	375	392	410	436	467	486	514	533	551	569	587	605	624	655	673	47,8	31,5	35,5	43,8	
	2700	347	365	383	401	418	445	476	495	524	542	561	579	598	617	635	666	684	49,8	32,5	37,0	45,3	
	2800	355	373	391	409	428	454	486	505	534	553	572	590	609	628	647	679	697	51,5	34,0	38,3	47,0	
	2900	363	382	400	418	436	463	496	515	545	564	583	602	620	640	658	691	721	53,3	35,0	39,8	48,5	
	3000	371	389	408	426	445	472	505	525	555	574	593	612	632	651	670	714	733	55,5	36,5	41,0	50,5	
	3100	386	406	425	445	464	506	527	548	578	598	619	639	659	704	724	745	765	57,3	37,8	42,8	52,3	
3200	394	414	434	454	474	516	537	558	589	609	629	650	670	716	737	757	778	59,0	38,8	44,0	53,8		

Top rail's mounting brackets	2 pieces										3 pieces							
10 mm bracket	INCLUDED IN THE PRICE																	
20 mm bracket (1 pcs)*	4,50	5,25	5,75	6,25	6,75	7,25	8,00	8,50	9,00	9,50	10,25	10,75	11,50	12,00	12,50	13,00	13,52	
40 mm bracket (1 pcs)*	10,00	11,25	12,50	13,75	15,00	16,00	17,50	18,75	20,00	21,25	22,25	23,75	25,00	26,25	27,50	28,50	29,90	
Bottom gutter in RAL colour	3,50	4,00	4,50	5,00	5,50	5,75	6,25	6,50	7,00	7,50	8,00	8,50	8,75	9,25	9,50	10,25	10,40	

**WARNING! NARROW JALOUSIES - ARROW EFFECT.** An arrow effect may occur on narrow jalousies with two winding mechanisms. This effect will occur if, during the rolling of the jalousies, the string from the ladder gets between the slats and causes an uneven increase in the thickness of the bundle on the left and right side. This effect is visible if the jalousie is narrow, and additionally may increase if the jalousie is narrow and high at the same time.

**System's price includes:**

- cassette,
- 10 mm brackets,
- 2 side guides,
- mounting brackets of the top rail,
- slats package with bottom gutter,
- 90° slats rotation,
- slats and construction in colours according to the colour table on page 25.

**Surcharges:**

- drive and electric control – page 26,
- 180° slat rotation +5%,
- XPS insulation – page 11-12,
- varnishing of the cassette – page 11-12,
- varnishing of the bottom gutter (the table above),
- varnishing of side guides (the table above),
- off-sets of the guides (the table above),
- 20 or 40 mm brackets (the table above).

\* the price for one bracket on the back or front of the cassette (the second and third variants of cassette configuration), in the case of selecting the fourth cassette configuration variant (two brackets - one at the front, the second at the back), the above surcharge should be multiplied by two.

C80 BOX PREMIUM facade jalousies																	Net prices in Euro, dimensions in mm				
height of cassette	total height of jalousie	width															surcharge for guides in RAL colour (2 pieces)	Side guide 10 mm offset (2 pcs)	Side guide 20 mm offset (2 pcs)	Side guide 40 mm offset (2 pcs)	
		2500	2600	2700	2800	2900	3000	3100	3200	3300	3400	3500	3600	3700	3800	3900					4000
200	800	444	464	477	490	503	516	529	542	555	567	590	608	621	634	647	660	14,8	9,5	11,3	13,3
	900	457	477	490	504	517	530	543	557	570	583	605	624	637	651	664	677	16,8	10,8	12,3	15,0
240	1000	469	490	503	517	530	544	557	570	584	597	620	640	653	667	680	694	18,5	12,3	13,5	16,8
	1100	482	503	517	530	544	558	571	585	599	612	636	656	669	683	696	710	20,3	13,3	15,0	18,5
	1200	495	516	530	544	558	572	586	600	614	628	651	671	685	699	714	727	22,0	14,5	16,5	20,0
	1300	507	529	544	558	572	586	600	615	629	643	667	687	702	716	730	744	24,0	15,8	18,0	21,8
	1400	520	542	557	571	585	600	614	629	643	658	683	703	717	732	746	761	25,8	17,0	19,3	23,5
	1500	533	555	570	585	599	614	629	643	658	673	698	719	734	748	763	778	27,5	18,3	20,3	25,3
	1600	546	568	583	598	613	628	643	658	673	688	714	735	749	765	780	795	29,5	19,3	21,8	27,0
	1700	577	600	616	632	648	664	680	696	712	728	755	777	793	809	825	840	31,3	20,8	23,3	28,5
300	1800	590	613	629	646	662	678	694	710	727	743	771	793	809	825	841	857	33,3	21,8	24,8	30,5
	1900	603	626	643	659	676	693	709	725	742	758	786	808	825	841	858	875	35,0	23,0	26,0	32,0
	2000	615	639	656	673	689	706	722	740	756	773	802	824	841	857	885	903	37,0	24,3	27,5	33,5
	2100	628	652	669	686	703	720	737	754	771	788	817	840	868	885	902	919	38,8	25,5	28,5	35,0
	2200	640	665	683	700	717	734	752	769	786	803	844	867	884	902	919	936	40,5	26,5	30,3	37,0
	2300	653	678	695	713	730	748	765	783	812	829	859	883	900	917	935	953	42,5	27,8	31,5	38,5
350	2400	666	691	709	727	744	762	791	809	826	844	875	899	916	934	952	970	44,3	29,0	32,8	40,3
	2500	678	704	722	740	769	787	806	824	841	860	891	915	932	951	969	987	46,0	30,5	34,3	41,8
	2600	691	717	747	765	784	802	820	851	869	887	906	930	949	967	985	1004	47,8	31,5	35,5	43,8
	2700	704	741	759	778	797	815	834	865	884	903	922	946	964	983	1001	1020	49,8	32,5	37,0	45,3
	2800	728	754	773	792	811	829	848	880	899	917	937	962	980	999	1018	1037	51,5	34,0	38,3	47,0
	2900	741	767	786	806	824	844	863	895	914	933	953	977	997	1016	1035	1054	53,3	35,0	39,8	48,5
	3000	753	780	799	818	838	857	877	909	929	948	968	993	1012	1032	1051	1071	55,5	36,5	41,0	50,5
	3100	786	813	834	854	888	909	929	949	969	990	1011	1037	1071	1092	1112	1132	57,3	37,8	42,8	52,3
3200	799	827	847	868	903	923	944	964	985	1005	1027	1053	1087	1108	1129	1149	59,0	38,8	44,0	53,8	

Top rail's mounting brackets	3 pieces							4 pieces								
10 mm bracket	INCLUDED IN THE PRICE															
20 mm bracket (1 pcs)*	14,30	14,82	15,34	15,86	16,38	16,90	17,68	18,20	18,72	19,24	19,76	20,28	21,06	21,58	22,10	22,62
40 mm bracket (1 pcs)*	31,20	32,50	33,54	34,84	36,14	37,44	38,74	39,78	41,08	42,38	43,68	44,98	46,02	47,32	48,62	49,92
Bottom gutter in RAL colour	11,18	11,70	11,96	12,48	12,74	13,26	13,52	14,30	14,56	15,08	15,60	15,86	16,38	16,64	17,16	17,68

**WARNING! NARROW JALOUSIES - ARROW EFFECT.** An arrow effect may occur on narrow jalousies with two winding mechanisms. This effect will occur if, during the rolling of the jalousies, the string from the ladder gets between the slats and causes an uneven increase in the thickness of the bundle on the left and right side. This effect is visible if the jalousie is narrow, and additionally may increase if the jalousie is narrow and high at the same time.

**System's price includes:**

- cassette,
- 10 mm brackets,
- 2 side guides,
- mounting brackets of the top rail,
- slats package with bottom gutter,
- 90° slats rotation,
- slats and construction in colours according to the colour table on page 25.

**Surcharges:**

- drive and electric control – page 26,
- 180° slat rotation +5%,
- XPS insulation – page 11-12,
- varnishing of the cassette – page 11-12,
- varnishing of the bottom gutter (the table above),
- varnishing of side guides (the table above),
- off-sets of the guides (the table above),
- 20 or 40 mm brackets (the table above).

\* the price for one bracket on the back or front of the cassette (the second and third variants of cassette configuration), in the case of selecting the fourth cassette configuration variant (two brackets - one at the front, the second at the back), the above surcharge should be multiplied by two.

**C80 slats package in standard colour, other colours at extra charge (according to the key below the table)**

Net prices in Euro, dimensions in mm

height of cassette	total height of jalousie	width																																
		800	900	1000	1100	1200	1300	1400	1500	1600	1700	1800	1900	2000	2100	2200	2300	2400	2500	2600	2700	2800	2900	3000	3100	3200	3300	3400	3500	3600	3700	3800	3900	4000
200	800	103	108	113	118	123	128	132	136	137	152	156	161	165	170	175	179	183	189	189	201	205	209	214	218	223	228	232	242	243	247	251	255	260
	900	109	114	119	125	129	135	140	145	146	160	165	170	175	180	185	190	195	199	202	212	219	223	228	233	238	242	248	258	259	264	268	273	277
240	1000	113	119	125	130	136	142	147	153	155	168	174	180	184	190	195	201	207	211	215	226	232	236	242	247	252	257	263	274	275	280	285	290	295
	1100	119	125	130	137	143	148	155	161	163	178	183	189	195	201	207	212	220	224	227	239	245	250	255	262	267	273	278	290	291	296	302	307	312
	1200	125	132	137	143	150	156	162	169	172	188	193	199	206	212	218	223	230	236	239	251	258	264	271	277	282	289	294	305	308	313	318	325	330
	1300	130	136	143	150	156	164	170	176	180	195	203	209	215	222	228	236	242	249	251	265	271	277	284	290	297	303	310	321	324	330	337	343	349
	1400	135	142	149	156	163	170	177	183	189	205	211	219	225	233	239	246	253	260	263	278	284	292	298	305	311	318	325	337	340	347	353	359	366
	1500	140	148	155	163	170	178	185	193	196	213	221	228	235	243	250	257	265	272	275	291	297	305	312	319	327	333	340	353	356	363	370	377	384
	1600	141	149	157	164	172	180	188	195	201	218	226	234	242	248	256	265	272	280	284	299	307	314	321	328	337	344	351	364	368	375	382	389	397
300	1700	146	154	162	171	177	187	195	204	208	227	234	243	251	259	267	275	283	292	296	312	320	327	336	343	350	359	367	380	384	391	399	405	414
	1800	163	172	181	190	198	206	215	223	229	247	255	264	273	281	290	298	307	315	320	336	344	351	360	369	377	386	394	407	412	419	428	435	444
	1900	168	176	186	194	204	214	222	232	237	256	264	274	283	292	301	309	318	327	333	349	357	366	375	384	392	402	410	423	428	436	444	452	461
	2000	173	183	192	202	212	220	230	239	246	265	274	283	292	303	312	321	329	339	345	361	370	379	388	397	406	416	425	438	444	452	461	470	478
	2100	177	188	198	208	218	228	237	248	254	274	283	293	303	312	322	331	342	351	358	374	383	393	403	412	422	431	441	454	459	469	478	487	496
	2200	183	193	204	215	226	235	246	255	262	282	293	304	312	323	334	344	353	363	370	387	398	406	416	427	437	446	457	470	476	486	495	504	514
350	2300	188	200	211	220	231	243	252	264	271	291	302	312	323	334	344	355	366	376	382	400	411	421	430	441	450	462	473	486	493	502	513	522	532
	2400	193	204	216	227	238	249	260	271	279	301	312	322	333	344	355	365	376	388	395	413	423	434	445	456	466	476	488	502	508	519	529	539	549
	2500	199	209	222	233	245	256	268	280	287	310	321	332	343	354	366	377	388	400	407	426	436	447	459	469	481	492	503	518	525	536	547	557	567
	2600	200	212	223	236	247	259	271	284	291	314	326	338	349	361	372	384	396	408	415	435	444	456	468	479	491	502	514	529	537	547	558	570	580
	2700	204	217	229	241	254	265	278	290	300	321	334	346	359	370	382	395	407	419	428	446	458	470	482	494	505	517	530	545	554	564	576	587	598
	2800	210	222	236	248	260	274	286	300	308	331	344	356	368	382	394	406	418	431	440	459	472	484	496	508	520	532	545	561	569	581	592	604	615
	2900	216	228	240	255	267	280	294	307	317	340	353	366	379	392	404	417	430	443	452	472	485	497	510	522	534	548	560	577	585	597	610	621	633
	3000	220	234	247	259	274	287	301	315	325	349	362	375	388	401	415	428	441	455	464	485	498	511	524	537	549	561	576	592	602	614	626	639	651
3100	237	252	265	278	293	307	321	334	345	370	383	397	410	425	438	452	465	478	488	508	522	537	549	563	576	589	603	620	629	642	655	668	681	
3200	242	256	271	285	300	314	328	343	353	378	393	407	421	435	448	463	477	490	501	522	536	549	563	577	592	604	618	636	646	658	672	685	698	

Bottom gutter in RAL colour	3,50	4,00	4,50	5,00	5,50	5,75	6,25	6,50	7,00	7,50	8,00	8,50	8,75	9,25	9,50	10,25	10,40	11,18	11,70	11,96	12,48	12,74	13,26	13,52	14,30	14,56	15,08	15,60	15,86	16,38	16,64	17,16	17,68
-----------------------------	------	------	------	------	------	------	------	------	------	------	------	------	------	------	------	-------	-------	-------	-------	-------	-------	-------	-------	-------	-------	-------	-------	-------	-------	-------	-------	-------	-------

**WARNING! NARROW JALOUSIES - ARROW EFFECT.** An arrow effect may occur on narrow jalousies with two winding mechanisms. This effect will occur if, during the rolling of the jalousies, the string from the ladder gets between the slats and causes an uneven increase in the thickness of the bundle on the left and right side. This effect is visible if the jalousie is narrow, and additionally may increase if the jalousie is narrow and high at the same time.

**The price of the package includes:**

- 80 mm wide aluminum slats, painted with varnish resistant to weather conditions,
- the textile tape made of special materials (fibers with the addition of Kevlar),
- a ladder made of polyester resistant to weather changes and UV radiation,
- bottom gutter with dimension of 80 x 13 mm.

**C80 colours at extra charge:**

- nut +50 %,
- golden oak +50 %.

**SLAT**

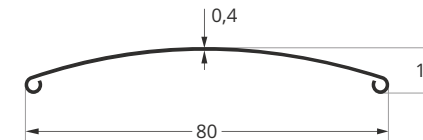





### SLATS PACKAGE

- 93 mm wide aluminum slat, painted with resistant to weather conditions varnish.
- bottom gutter with dimensions of 92 x 15 mm.
- a textile tape made of special fibers with the addition of Kevlar.
- a package of jalousie as standard fixed with automatic brackets of the top rail mounting.
- maximum jalousie dimensions: width: 4000 mm, height: 3500 mm, surface area according to the table.

### GUIDANCE THE SLAT

- guides made of aluminum, 88,4 mm wide, fixed to the window or window recess.

### CASSETTE

- cassette made of 1.2 mm thick aluminum is available in three heights - H = 200/240/300 mm.
- as standard (no extra charge) it is possible to use 10 mm brackets, 20 and 40 mm brackets are available for an extra charge

### DRIVE

- drives for an extra charge, table on page 26.
- depending of the size of the jalousie the appropriate drive power needs to be selected.

### CASSETTES

- Variant 1 and 2** - without cassette building in, surface mounting.
- Variant 2** - 10mm bracket on the back side of the cassette.

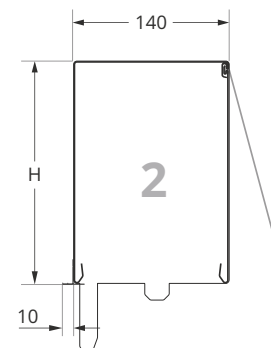
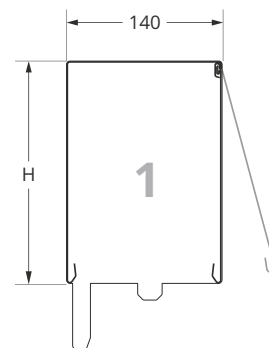

### SLAT

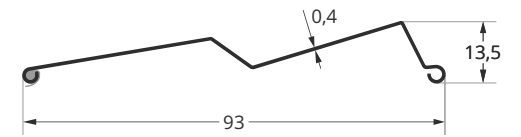

### BOX PREMIUM GUIDE

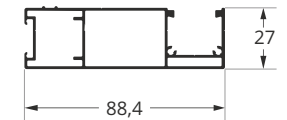

### OFF-SETS OF THE GUIDE

(used with brackets)

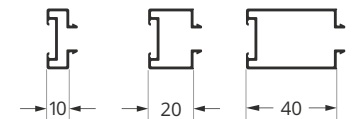

### BRACKETS

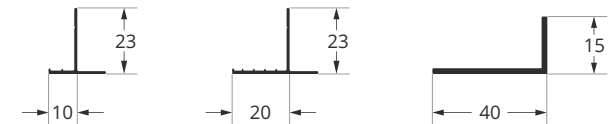

**Variants 3 and 4** - cassette for building in.

**Variant 3** - 10 mm bracket on the front side of the cassette.

**Variant 4** - 10 mm bracket on the back and front sides of the cassette.

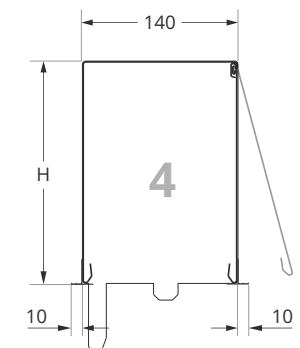
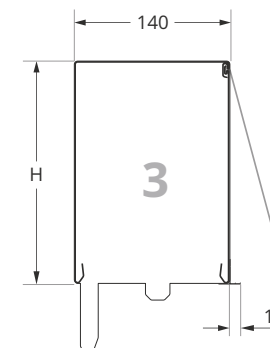

## Z90 BOX PREMIUM facade jalousies

Net prices in Euro, dimensions in mm

height of cassette	total height of jalousie	width																			surcharge for guides in RAL colour (2 pcs)	Side guide 10 mm off-set (2 pcs)	Side guide 20 mm off-set (2 pcs)	Side guide 40 mm off-set (2 pcs)		
		800	900	1000	1100	1200	1300	1400	1500	1600	1700	1800	1900	2000	2100	2200	2300	2400	2500	2600						
200	800	194	207	219	231	243	264	277	301	325	338	350	363	376	389	403	416	429	442	453	473	14,8	9,5	11,3	13,3	
	900	203	216	229	241	253	275	288	313	337	350	363	376	389	403	416	429	442	456	468	488	16,8	10,8	12,3	15,0	
	1000	212	225	238	251	264	285	299	325	349	362	376	389	403	416	429	443	456	483	504	504	18,5	12,3	13,5	16,8	
	1100	221	234	247	260	274	295	309	336	360	374	388	401	415	429	442	456	470	498	519	519	20,3	13,3	15,0	18,5	
	1200	230	243	257	270	284	306	319	348	372	386	400	414	428	442	456	470	484	513	534	534	22,0	14,5	16,5	20,0	
	1300	239	252	266	280	293	316	330	359	384	398	412	426	441	455	469	484	498	527	549	549	24,0	15,8	18,0	21,8	
	1400	248	261	275	290	303	326	340	371	396	410	425	440	454	468	483	498	512	543	565	565	25,8	17,0	19,3	23,5	
	1500	256	271	285	299	314	337	351	382	408	422	437	452	467	482	497	512	527	558	580	580	27,5	18,3	20,3	25,3	
	1600	265	280	294	309	323	346	362	394	419	434	449	464	480	495	510	525	540	573	595	595	29,5	19,3	21,8	27,0	
1700	274	289	304	319	334	357	372	405	431	446	462	477	493	508	524	539	555	588	611	611	31,3	20,8	23,3	28,5		
240	1800	283	298	313	328	343	367	382	416	442	458	474	490	506	521	537	553	568	603	626	626	33,3	21,8	24,8	30,5	
	1900	298	314	330	346	362	387	404	440	466	483	500	516	533	550	567	583	600	636	660	660	35,0	23,0	26,0	32,0	
	2000	307	323	340	356	372	397	414	451	478	495	512	529	547	564	580	597	614	651	675	675	37,0	24,3	27,5	33,5	
	2100	316	332	349	366	382	407	425	463	490	507	525	542	559	576	593	611	629	666	690	690	38,8	25,5	28,5	35,0	
	2200	325	342	359	376	393	418	435	474	501	519	537	555	572	590	607	625	642	681	706	706	40,5	26,5	30,3	37,0	
	2300	334	351	368	385	403	428	446	486	514	532	549	567	585	603	621	639	657	696	721	721	42,5	27,8	31,5	38,5	
	2400	342	360	377	395	412	438	456	497	525	543	561	580	598	616	634	652	671	711	737	737	44,3	29,0	32,8	40,3	
	2500	351	369	387	404	423	449	467	508	537	555	574	592	611	629	648	666	684	726	752	752	46,0	30,5	34,3	41,8	
300	2600	360	378	396	414	432	459	500	520	549	567	586	605	624	642	661	703	721	741	767	767	47,8	31,5	35,5	43,8	
	2700	369	387	406	424	442	469	512	532	560	580	599	618	637	656	675	717	737	756	793	793	49,8	32,5	37,0	45,3	
	2800	385	404	424	443	463	490	535	555	586	606	626	646	666	686	706	750	770	802	829	829	51,5	34,0	38,3	47,0	
	2900	394	414	433	453	473	500	546	567	597	618	638	658	678	699	719	764	795	816	844	844	53,3	35,0	39,8	48,5	
	3000	403	423	442	463	483	511	558	579	609	630	651	671	692	712	733	790	810	831	859	859	55,5	36,5	41,0	50,5	
	3100	411	431	452	472	492	548	568	590	620	642	662	683	704	726	747	783	804	825	846	875	875	57,3	37,8	42,8	52,3
	3200	420	441	462	482	503	559	580	602	633	654	675	696	717	738	776	797	818	840	861	890	890	59,0	38,8	44,0	53,8
	3300	429	450	471	492	513	570	591	613	645	666	688	720	741	791	812	833	854	877	905	905	60,8	40,0	45,0	55,8	
	3400	438	459	480	501	522	580	602	624	656	678	699	732	754	804	825	847	869	891	920	920	62,8	41,0	46,5	57,0	
350	3500	447	468	490	511	533	592	614	636	668	690	712	745	767	818	840	862	884	906	936	936	64,5	42,8	47,8	58,8	
	3600	456	478	500	521	543	603	625	647	680	702	724	762	785	832	854	876	899	922	951	951	66,3	44,8	49,8	60,5	
	3700	465	487	509	531	553	614	636	659	692	714	737	778	801	846	868	891	913	937	966	966	68,0	47,0	52,0	62,3	
	3800	474	496	519	541	563	624	648	670	703	726	749	794	817	860	882	905	928	952	981	981	69,8	49,5	54,5	64,0	
	3900	483	505	528	551	573	635	659	682	715	739	761	809	833	874	896	920	943	967	997	997	71,5	52,3	57,3	65,8	
4000	492	515	538	561	584	646	670	693	727	751	774	825	849	888	911	934	957	982	1012	1012	73,3	55,0	60,0	67,5		
<b>Top rail's mounting brackets</b>		2 pieces											3 pieces													
<b>10 mm bracket</b>		INCLUDED IN THE PRICE																								
<b>20 mm bracket (1 pcs)*</b>		4,50	5,25	5,75	6,25	6,75	7,25	8,00	8,50	9,00	9,50	10,25	10,75	11,50	12,00	12,50	13,00	13,50	14,00	14,50						
<b>40 mm bracket (1 pcs)*</b>		10,00	11,25	12,50	13,75	15,00	16,00	17,50	18,75	20,00	21,25	22,25	23,75	25,00	26,25	27,50	28,50	29,75	30,93	32,10						
<b>Bottom gutter in RAL colour</b>		3,50	4,00	4,50	5,00	5,50	5,75	6,25	6,50	7,00	7,50	8,00	8,50	8,75	9,25	9,50	10,25	10,67	11,17	11,67						

### System's price includes:

- cassette,
- slats package with bottom gutter,
- 10 mm brackets,
- slats and construction in colours according to the colour table on page 25.
- 2 side guides,
- mounting brackets of the top rail,

### Surcharges:

- drive and electric control - page 26,
- varnishing of side guides (the table above),
- XPS insulation - page 11-12,
- off-sets of the guides (the table above),
- varnishing of the cassette - page 11-12,
- 20 or 40 mm brackets (the table above).
- varnishing of the bottom gutter (the table above),

**WARNING! NARROW JALOUSIES - ARROW EFFECT.** An arrow effect may occur on narrow jalousies with two winding mechanisms. This effect will occur if, during the rolling of the jalousies, the string from the ladder gets between the slats and causes an uneven increase in the thickness of the bundle on the left and right side. This effect is visible if the jalousie is narrow, and additionally may increase if the jalousie is narrow and high at the same time.

\* the price for one bracket on the back or front of the cassette (the second and third variants of cassette configuration), in the case of selecting the fourth cassette configuration variant (two brackets - one at the front, the second at the back), the above surcharge should be multiplied by two.

## Z90 BOX PREMIUM facade jalousies

Net prices in Euro, dimensions in mm

height of cassette	total height of jalousie	width																			surcharge for guides in RAL colour (2 pieces)	Side guide 10 mm off-set (2 pcs)	Side guide 20 mm off-set (2 pcs)	Side guide 40 mm off-set (2 pcs)
		2700	2800	2900	3000	3100	3200	3300	3400	3500	3600	3700	3800	3900	4000	4100	4200	4300	4400	4500				
200	800	486	499	511	525	538	551	564	576	601	620	633	646	659	672	685	698	711	724	737	14,8	9,5	11,3	13,3
	900	501	515	528	541	555	568	581	594	620	639	652	665	678	692	706	720	733	747	761	16,8	10,8	12,3	15,0
	1000	517	531	544	558	571	585	598	612	639	658	671	685	698	712	726	739	753	766	780	18,5	12,3	13,5	16,8
	1100	533	546	560	574	588	602	615	629	657	677	690	704	718	732	746	760	774	788	802	20,3	13,3	15,0	18,5
	1200	548	563	576	591	605	619	633	647	675	695	709	724	738	752	766	780	794	808	822	22,0	14,5	16,5	20,0
	1300	564	578	592	607	621	636	650	664	694	714	728	743	757	772	786	801	816	831	846	24,0	15,8	18,0	21,8
	1400	579	594	609	624	638	652	667	682	712	733	748	762	777	791	806	820	835	850	864	25,8	17,0	19,3	23,5
	1500	595	610	625	640	655	670	685	700	731	752	767	782	797	812	827	842	857	872	887	27,5	18,3	20,3	25,3
	1600	610	626	641	656	671	687	702	717	749	771	786	801	816	831	846	862	877	892	907	29,5	19,3	21,8	27,0
	1700	626	642	657	673	688	704	719	735	768	789	805	820	836	851	866	882	897	912	927	31,3	20,8	23,3	28,5
240	1800	642	657	673	689	705	721	736	752	786	808	824	839	855	871	887	903	919	935	950	33,3	21,8	24,8	30,5
	1900	677	694	710	727	744	761	778	794	830	853	870	887	904	920	936	953	969	986	1002	35,0	23,0	26,0	32,0
	2000	693	710	727	744	761	778	795	812	849	872	889	906	924	941	958	976	994	1011	1028	37,0	24,3	27,5	33,5
	2100	708	725	743	760	778	795	812	829	867	891	919	936	953	970	988	1005	1022	1039	1056	38,8	25,5	28,5	35,0
	2200	724	741	759	777	794	812	830	847	887	920	938	955	973	991	1009	1027	1045	1063	1081	40,5	26,5	30,3	37,0
	2300	740	758	775	793	812	829	858	876	915	939	957	975	993	1011	1028	1046	1064	1081	1099	42,5	27,8	31,5	38,5
	2400	755	773	791	810	838	856	875	893	934	958	976	994	1012	1031	1049	1067	1086	1104	1123	44,3	29,0	32,8	40,3
	2500	771	789	818	837	855	873	892	911	952	976	995	1014	1032	1051	1069	1087	1106	1124	1143	46,0	30,5	34,3	41,8
300	2600	796	815	834	853	872	914	932	951	970	995	1014	1033	1052	1071	1090	1109	1127	1146	1165	47,8	31,5	35,5	43,8
	2700	812	831	850	870	888	931	951	969	989	1014	1033	1052	1071	1090	1110	1129	1148	1167	1187	49,8	32,5	37,0	45,3
	2800	849	869	889	909	929	974	994	1014	1035	1060	1080	1100	1120	1141	1161	1181	1202	1222	1242	51,5	34,0	38,3	47,0
	2900	864	885	905	925	945	991	1012	1032	1053	1079	1099	1120	1140	1160	1181	1201	1221	1241	1262	53,3	35,0	39,8	48,5
	3000	880	901	921	942	963	1009	1029	1050	1071	1098	1119	1139	1160	1181	1201	1222	1243	1264	1285	55,5	36,5	41,0	50,5
	3100	895	916	964	985	1006	1027	1047	1068	1090	1117	1164	1185	1206	1227	1248	1269	1290	1311	1332	57,3	37,8	42,8	52,3
	3200	911	932	980	1002	1023	1044	1066	1087	1108	1136	1184	1205	1226	1248	1269	1291	1312	1334	1356	59,0	38,8	44,0	53,8
	3300	927	948	997	1019	1040	1062	1084	1105	1127	1155	1204	1225	1247	1268	1290	1312	1333	1355	1376	60,8	40,0	45,0	55,8
	3400	942	964	1014	1036	1058	1080	1068	1123	1146	1173	1223	1245	1267	1288	1310	1332	1354	1376	1398	62,8	41,0	46,5	57,0
350	3500	958	980	1031	1054	1075	1097	1119	1141	1164	1192	1243	1265	1287	1309	1332	1354	1376	1398	1420	64,5	42,8	47,8	58,8
	3600	973	996	1048	1071	1092	1115	1120	1159	1183	1211	1263	1285	1308	1330	1352	1374	1397	1419	1441	66,3	44,8	49,8	60,5
	3700	989	1012	1064	1088	1110	1132	1135	1178	1201	1229	1283	1305	1328	1350	1373	1395	1418	1440	1463	68,0	47,0	52,0	62,3
	3800	1005	1028	1081	1105	1127	1150	1149	1196	1220	1248	1302	1325	1348	1371	1394	1416	1439	1461	1484	69,8	49,5	54,5	64,0
	3900	1020	1044	1098	1122	1144	1167	1164	1214	1239	1267	1322	1346	1369	1392	1414	1437	1460	1483	1505	71,5	52,3	57,3	65,8
4000	1036	1060	1115	1140	1161	1185	1178	1232	1257	1286	1342	1366	1389	1412	1435	1458	1481	1504	1527	73,3	55,0	60,0	67,5	
Top rail's mounting brackets		3 pieces			4 pieces																			
10 mm bracket		INCLUDED IN THE PRICE																						
20 mm bracket (1 pcs)*		15,00	15,50	16,00	16,50	17,00	17,50	18,00	18,50	19,00	19,50	20,00	20,50	21,00	21,50	22,00	22,50	23,00	23,50	24,00				
40 mm bracket (1 pcs)*		33,28	34,45	35,63	36,80	37,98	39,15	40,33	41,50	42,68	43,85	45,03	46,20	47,38	48,55	49,73	50,90	52,08	53,25	54,43				
Bottom gutter in RAL colour		12,17	12,67	13,17	13,67	14,17	14,67	15,17	15,67	16,17	16,67	17,17	17,67	18,17	18,67	19,17	19,67	20,17	20,67	21,17				

### System's price includes:

- cassette,
- slats package with bottom gutter,
- 10 mm brackets,
- slats and construction in colours according to the colour table on page 25.
- 2 side guides,
- mounting brackets of the top rail,

### Surcharges:

- drive and electric control - page 26,
- varnishing of side guides (the table above),
- XPS insulation - page 11-12,
- off-sets of the guides (the table above),
- varnishing of the cassette - page 11-12,
- 20 or 40 mm brackets (the table above).
- varnishing of the bottom gutter (the table above),

**WARNING! NARROW JALOUSIES - ARROW EFFECT.** An arrow effect may occur on narrow jalousies with two winding mechanisms. This effect will occur if, during the rolling of the jalousies, the string from the ladder gets between the slats and causes an uneven increase in the thickness of the bundle on the left and right side. This effect is visible if the jalousie is narrow, and additionally may increase if the jalousie is narrow and high at the same time.

\* the price for one bracket on the back or front of the cassette (the second and third variants of cassette configuration), in the case of selecting the fourth cassette configuration variant (two brackets - one at the front, the second at the back), the above surcharge should be multiplied by two.



<b>Cassette 200 mm</b>																							<i>Net prices in Euro, dimensions in mm</i>										
	800	900	1000	1100	1200	1300	1400	1500	1600	1700	1800	1900	2000	2100	2200	2300	2400	2500	2600	2700	2800	2900	3000	3100	3200	3300							
Cassette 200 mm	163,00	173,00	183,00	193,00	202,75	218,25	228,75	239,25	260,00	270,50	281,25	291,00	301,25	312,00	323,00	334,00	344,00	353,75	372,75	384,50	395,75	400,25	411,50	424,50	433,50	443,50							
Surcharge XPS 10 mm*	2,75	3,00	3,75	4,00	4,25	4,75	5,00	5,25	5,75	6,00	6,25	6,75	7,00	7,25	7,75	8,00	8,25	8,75	9,00	9,50	10,00	10,25	10,75	11,00	11,25	11,75							
Surcharge XPS 20 mm*	6,50	7,25	8,25	9,00	10,00	10,75	11,50	12,25	13,25	14,00	14,75	15,50	16,50	17,25	18,25	19,00	19,75	20,50	21,25	22,00	23,00	24,00	24,75	25,50	26,25	27,00							
Surcharge XPS 40 mm*	4,50	5,00	5,75	6,25	6,75	7,25	7,75	8,25	8,75	9,50	10,25	10,75	11,25	11,75	12,25	13,00	13,50	14,00	14,50	15,00	15,50	16,50	17,00	17,50	18,00	18,50							

\* the price for insulation on the back or front of the cassette (the second and third variants of cassette configuration), in the case of selecting the fourth cassette configuration variant (insulation of front and back) the the above surcharge should be multiplied by two.

<b>Cassette 240 mm</b>																							<i>Net prices in Euro, dimensions in mm</i>										
	800	900	1000	1100	1200	1300	1400	1500	1600	1700	1800	1900	2000	2100	2200	2300	2400	2500	2600	2700	2800	2900	3000	3100	3200	3300							
Cassette 240 mm	175,75	186,75	198,75	209,75	220,75	241,75	254,00	265,50	288,75	300,50	312,25	324,25	336,50	348,50	359,75	372,00	384,25	396,25	413,75	426,00	437,50	449,50	461,50	473,50	485,25	497,00							
Surcharge XPS 10 mm*	3,50	4,00	4,25	4,75	5,25	5,50	6,00	6,25	6,75	7,25	7,50	8,00	8,25	8,75	9,25	9,50	10,25	10,75	11,00	11,50	11,75	12,25	12,75	13,00	13,50	14,00							
Surcharge XPS 20 mm*	7,75	8,75	10,00	11,00	11,75	12,75	13,75	14,75	15,75	16,75	17,75	18,75	19,75	20,75	21,50	22,50	23,75	24,75	25,75	26,50	27,50	28,50	29,75	30,75	31,50	32,50							
Surcharge XPS 40 mm*	5,50	6,00	6,75	7,25	8,00	8,75	9,25	10,25	10,75	11,50	12,25	12,75	13,50	14,00	14,75	15,50	16,00	17,00	17,50	18,25	18,75	19,50	20,25	20,75	21,50	22,00							

\* the price for insulation on the back or front of the cassette (the second and third variants of cassette configuration), in the case of selecting the fourth cassette configuration variant (insulation of front and back) the the above surcharge should be multiplied by two.

<b>Cassette 300 mm</b>																							<i>Net prices in Euro, dimensions in mm</i>										
	800	900	1000	1100	1200	1300	1400	1500	1600	1700	1800	1900	2000	2100	2200	2300	2400	2500	2600	2700	2800	2900	3000	3100	3200	3300							
Cassette 300 mm	184,25	195,50	207,50	219,50	230,50	252,50	264,50	277,25	300,25	312,75	325,25	337,50	350,00	362,50	374,75	387,00	399,25	411,75	430,00	442,00	454,50	466,75	479,25	492,00	504,00	516,00							
Surcharge XPS 10 mm*	4,25	4,75	5,25	5,75	6,25	6,75	7,25	7,75	8,25	9,00	9,50	10,25	10,75	11,25	11,75	12,25	12,75	13,25	13,75	14,25	14,75	15,25	15,75	16,50	17,00	17,50							
Surcharge XPS 20 mm*	10,00	11,25	12,25	13,50	14,75	16,00	17,25	18,50	19,75	21,00	22,00	23,50	24,75	26,00	27,00	28,25	29,75	30,75	32,00	33,25	34,50	35,50	37,00	38,25	39,50	40,50							
Surcharge XPS 40 mm*	6,75	7,50	8,25	9,25	10,25	11,00	11,75	12,75	13,50	14,25	15,00	15,75	17,00	17,75	18,50	19,25	20,25	21,00	21,75	22,50	23,75	24,50	25,25	26,00	26,75	27,75							

\* the price for insulation on the back or front of the cassette (the second and third variants of cassette configuration), in the case of selecting the fourth cassette configuration variant (insulation of front and back) the the above surcharge should be multiplied by two.

<b>Cassette 350 mm</b>																							<i>Net prices in Euro, dimensions in mm</i>										
	800	900	1000	1100	1200	1300	1400	1500	1600	1700	1800	1900	2000	2100	2200	2300	2400	2500	2600	2700	2800	2900	3000	3100	3200	3300							
Cassette 350 mm	203,00	217,50	232,00	246,50	261,00	275,50	290,00	304,50	319,00	333,50	348,00	362,50	377,00	391,50	406,00	420,50	435,00	449,50	464,00	478,50	493,00	507,50	522,00	536,50	551,00	565,50							
Surcharge XPS 10 mm*	6,00	6,50	7,00	7,50	8,00	8,50	9,00	9,50	10,00	10,50	11,00	11,50	12,00	12,50	13,00	13,50	14,00	14,50	15,00	15,50	16,00	16,50	17,00	17,50	18,00	18,50							
Surcharge XPS 20 mm*	12,00	13,75	15,50	17,25	19,00	20,75	22,50	24,25	26,00	27,75	29,50	31,25	33,00	34,75	36,50	38,25	40,00	41,75	43,50	45,25	47,00	48,75	50,50	52,25	54,00	55,75							
Surcharge XPS 40 mm*	8,25	9,50	10,75	12,00	13,25	14,50	15,75	17,00	18,25	19,50	20,75	22,00	23,25	24,50	25,75	27,00	28,25	29,50	30,75	32,00	33,25	34,50	35,75	37,00	38,25	39,50							

\* the price for insulation on the back or front of the cassette (the second and third variants of cassette configuration), in the case of selecting the fourth cassette configuration variant (insulation of front and back) the the above surcharge should be multiplied by two.

<b>Varnishing</b>																							<i>Net prices in Euro, dimensions in mm</i>										
	800	900	1000	1100	1200	1300	1400	1500	1600	1700	1800	1900	2000	2100	2200	2300	2400	2500	2600	2700	2800	2900	3000	3100	3200	3300							
Varnishing of the cassette variant 1	4,50	5,25	5,75	6,50	7,00	7,75	8,25	9,00	9,75	10,25	11,00	11,50	12,25	13,00	13,50	14,25	14,75	15,50	16,25	16,75	17,50	18,00	18,75	19,50	20,00	20,75							
Varnishing of the cassette variant 2	11,50	12,75	14,25	15,75	17,00	18,50	19,75	21,50	22,75	24,25	25,50	27,00	28,25	29,75	31,25	32,50	34,00	35,50	36,75	38,25	39,75	41,00	42,50	44,00	45,25	46,75							

<b>Brackets</b>																							<i>Net prices in Euro, dimensions in mm</i>										
	800	900	1000	1100	1200	1300	1400	1500	1600	1700	1800	1900	2000	2100	2200	2300	2400	2500	2600	2700	2800	2900	3000	3100	3200	3300							
Bracket 10 mm	INCLUDED IN THE PRICE																																
Bracket 20 mm (1 pcs.)*	4,50	5,25	5,75	6,25	6,75	7,25	8,00	8,50	9,00	9,50	10,25	10,75	11,50	12,00	12,50	13,00	13,50	14,00	14,50	15,00	15,50	16,00	16,50	17,00	17,50	18,00							
Bracket 40 mm (1 pcs.)*	10,00	11,25	12,50	13,75	15,00	16,00	17,50	18,75	20,00	21,25	22,25	23,75	25,00	26,25	27,50	28,50	29,75	30,93	32,10	33,28	34,45	35,63	36,80	37,98	39,15	40,33							

\* the price for one bracket on the back or front of the cassette (the second and third variants of cassette configuration), in the case of selecting the fourth cassette configuration variant (two brackets - one at the front, the second at the back), the above surcharge should be multiplied by two.

### Standard varnishing - no surcharge.

As a standard, we varnish the bottom edges of the box and brackets (if there are any - depending on the selected configuration of the cassette) at no extra charge.



### Nonstandard varnishing - varnishing variants available at extra charge:

Varnishing variant 1.

Varnishing variant 2.

Varnishing variant 3.

(the price of variants 1 and 2 should be totaled up).

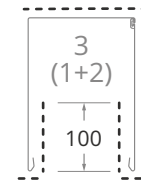
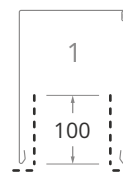



Guides for C-80 and Z90 BOX PREMIUM systems					Net prices in Euro, dimensions in mm	
height	guide - 2 pieces standard colour	surcharge for varnishing nonstandard colour (2 pieces)	surcharge for off-set 10 mm standard/nonstandard colour (2 pieces)	surcharge for off-set 20 mm standard/nonstandard colour (2 pieces)	surcharge for off-set 40 mm standard/nonstandard colour (2 pieces)	
800	56,8	14,8	9,5	11,3	13,3	
900	62,8	16,8	10,8	12,3	15,0	
1000	68,8	18,5	12,3	13,5	16,8	
1100	74,5	20,3	13,3	15,0	18,5	
1200	80,0	22,0	14,5	16,5	20,0	
1300	86,0	24,0	15,8	18,0	21,8	
1400	92,0	25,8	17,0	19,3	23,5	
1500	98,0	27,5	18,3	20,3	25,3	
1600	105,8	29,5	19,3	21,8	27,0	
1700	109,8	31,3	20,8	23,3	28,5	
1800	115,8	33,3	21,8	24,8	30,5	
1900	121,8	35,0	23,0	26,0	32,0	
2000	127,8	37,0	24,3	27,5	33,5	
2100	133,5	38,8	25,5	28,5	35,0	
2200	139,0	40,5	26,5	30,3	37,0	
2300	145,0	42,5	27,8	31,5	38,5	
2400	151,0	44,3	29,0	32,8	40,3	
2500	157,0	46,0	30,5	34,3	41,8	
2600	163,0	47,8	31,5	35,5	43,8	
2700	168,8	49,8	32,5	37,0	45,3	
2800	174,5	51,5	34,0	38,3	47,0	
2900	180,5	53,3	35,0	39,8	48,5	
3000	186,5	55,5	36,5	41,0	50,5	
3100	190,3	57,3	37,8	42,8	52,3	
3200	196,3	59,0	38,8	44,0	53,8	
3300	202,3	60,8	40,0	45,0	55,8	
3400	207,8	62,8	41,0	46,5	57,0	
3500	213,8	64,5	42,8	47,8	58,8	
3600	219,8	66,3	44,8	49,8	60,5	
3700	225,8	68,0	47,0	52,0	62,3	
3800	231,8	69,8	49,5	54,5	64,0	
3900	237,8	71,5	52,3	57,3	65,8	
4000	243,8	73,3	55,0	60,0	67,5	

"BOX" SIDE GUIDE

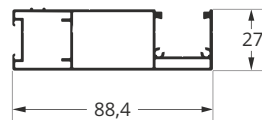

"BOX" SIDE GUIDE WITH 10 mm OFF-SET

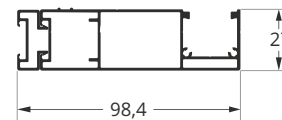

OFF-SET OF THE GUIDE

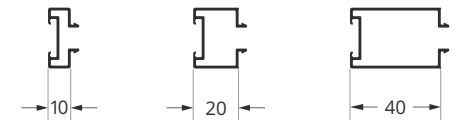

"BOX" SIDE GUIDE WITH 20 mm OFF-SET

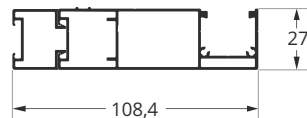

"BOX" SIDE GUIDE WITH 40 mm OFF-SET

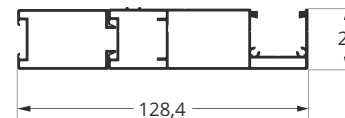

## Masking cover.

The masking cover is made of 1,5 mm thick aluminum, as a standard appears in raw aluminum colour. On special order and for an additional fee, it is possible to varnish it in a colour from the RAL palette.

The masking cover is also available in the option of its closure with side covers.

## Haberdashery.

The textile tape is made of special fibers with the addition of Kevlar, ensuring high toughness, abrasion resistance and colour durability.

The ladder is made of polyester and is available in gray or black.

## Bottom gutter.

Extruded aluminum profile with a width adapted to the type of slat, powder coated with high-quality varnishes resistant to weather conditions. The bottom gutter is finished with plastic plugs.

## Bottom gutter end cap.

Gutter side end cap is made of plastic, available in gray and black. The end cap has the bottom gutter guide pin bolt.

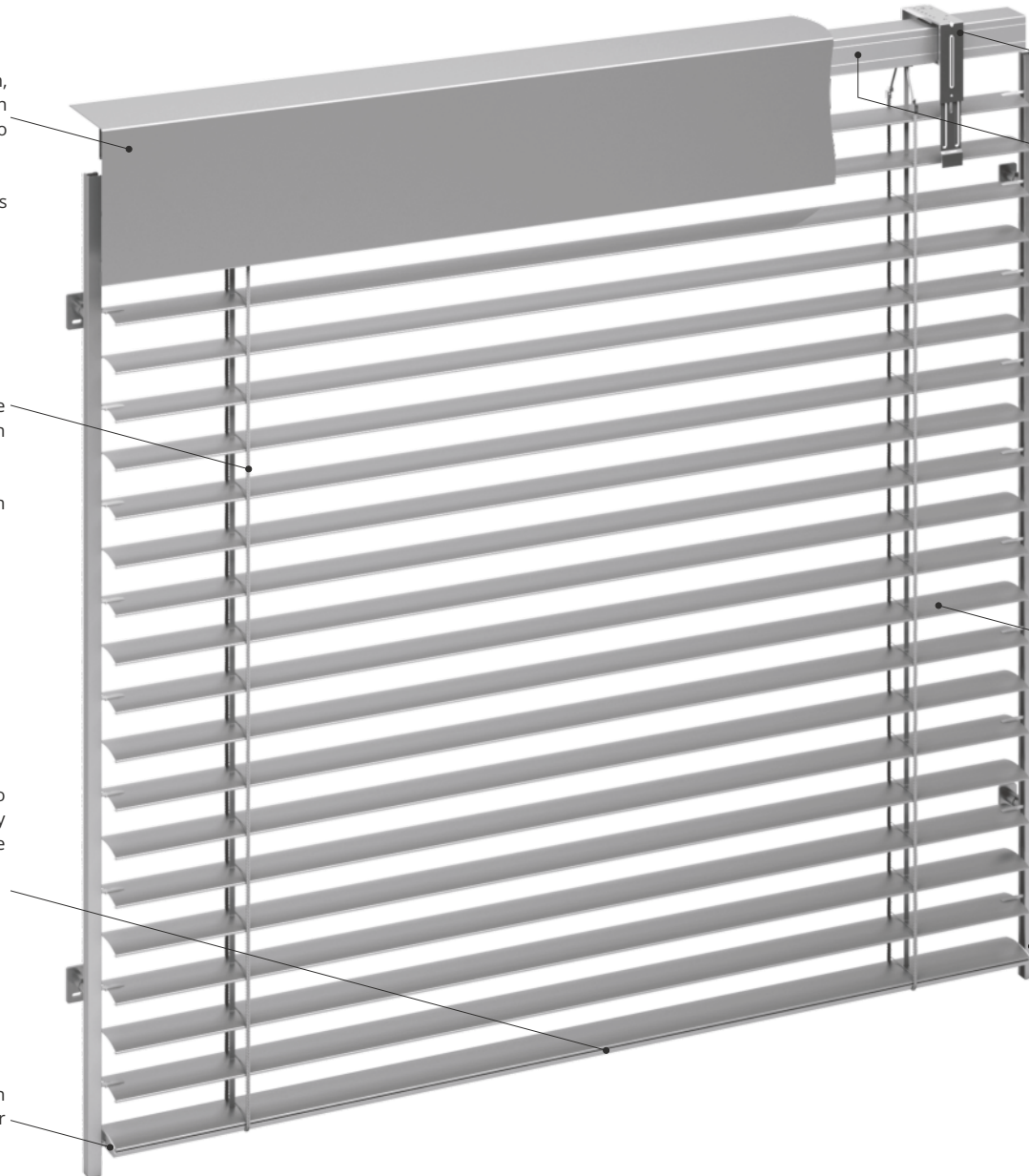

## Upper gutter mounting bracket.

Upper gutter mounting brackets are made of galvanized steel.

## Upper gutter.

56 x 58 mm cold-rolled U-shaped profile is made of heat-galvanized 0.6 mm thick steel sheet. The upper gutter is open downwards for easy service access.

## Control.

Automatic control of the jalousies using an electric motor with a voltage of 230 V / 50 Hz and an active power from 90 to 210 W.

## Slats.

A horizontal aluminum slat, approx. 0.4 mm thick and 80 or 93 mm wide, shaped in the rolling process, is covered with high-quality varnishes resistant to weather conditions.

## Lateral guidance.

Lateral guidance is provided by guides made of extruded aluminum, covered with high-quality varnishes resistant to weather conditions varnishes.





### SLATS PACKAGE

- 80 mm wide aluminum slat, painted with resistant to weather conditions varnish.
- as standard slat rotation 90°; 180° rotation for an additional charge of 5%.
- bottom gutter with dimensions of 80 x 13 mm.
- a textile tape made of special fibers with the addition of Kevlar.
- a package of jalousie as standard fixed with automatic brackets of the top rail mounting.
- maximum jalousie dimensions: width: 4000 mm, height: 5000 mm, surface area according to the table.

### GUIDANCE THE SLAT

- guides made of aluminum, 20 mm wide, fixed with holders.

### THE MASKING COVER

- masking cover made of 1,5 mm thick aluminium sheet, available in 5 heights – 220 / 260 / 300 / 350 / 380 mm (max. cover width: 4000 mm)
- the cover appears in raw aluminum colour as a standard. On special order and for an additional fee, it is possible to varnish it in a colour from the RAL palette. Below the table of surcharges for varnishing - the prices / surcharges include three varnishing variants (to be selected on the order form).

### DRIVE

- drives for an extra charge, table on page 26.
- depending of the size of the jalousie the appropriate drive power needs to be selected.

### MASKING COVER

#### Type 1

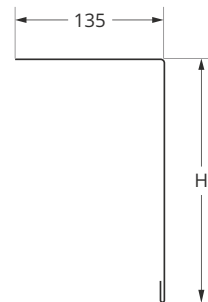

#### Type 2

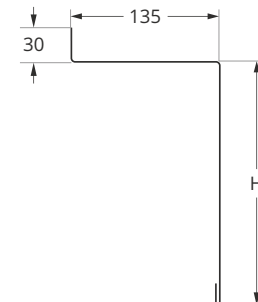

### SLAT

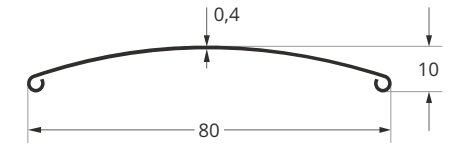

### GUIDES

#### A - single

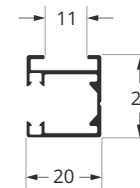

#### B - for sets

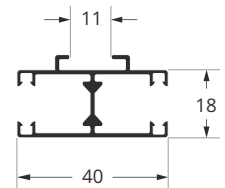

### SIDE GUIDES' BRACKETS

Available brackets variants:

- A1 50-70 mm
- A2 71-105 mm
- A3 106-170 mm
- A4 171-295 mm

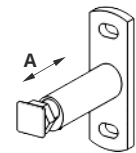

Price list of masking covers		Net prices in Euro
H height and cover type	price	varnishing
220 mm – type 1	36,00 € / rm	10,30 € / rm
220 mm – type 2	36,00€ / rm	11,00 € / rm
260 mm – type 1	55,00 € / rm	11,30 € / rm
260 mm – type 2	55,00 € / rm	12,00 € / rm
300 mm – type 1	55,00 € / rm	12,30 € / rm
300 mm – type 2	55,00 € / rm	13,30 € / rm
350 mm – type 2	55,00 € / rm	13,80 € / rm
350 mm – tyep 1	55,00 € / rm	14,50 € / rm
380 mm – type 2	55,00 € / rm	14,50 € / rm
380 mm – type 1	55,00 € / rm	15,30 € / rm
side cover	7,00 € / pcs.	2,80 € / pcs.





### SLATS PACKAGE

- 93 mm wide aluminum slat, painted with resistant to weather conditions varnish.
- bottom gutter with dimensions of 92 x 15 mm.
- a textile tape made of special fibers with the addition of Kevlar.
- a package of jalousie as standard fixed with automatic brackets of the top rail mounting.
- maximum jalousie dimensions: width: 4500 mm, height: 5000 mm, surface area according to the table.

### GUIDANCE THE SLAT

- guides made of aluminum, 20 mm wide, fixed with holders.

### THE MASKING COVER

- masking cover made of 1,5 mm thick aluminium sheet, available in 5 heights – 220 / 260 / 300 / 350 / 380 mm (max. cover width: 4000 mm)
- the cover appears in raw aluminum colour as a standard. On special order and for an additional fee, it is possible to varnish it in a colour from the RAL palette. Below the table of surcharges for varnishing - the prices / surcharges include three varnishing variants (to be selected on the order form).

### DRIVE

- drives for an extra charge, table on page 25.
- depending of the size of the jalousie the appropriate drive power needs to be selected.

### SLAT

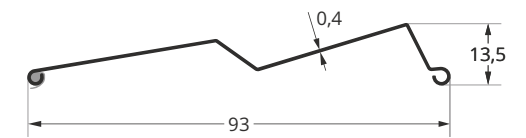

### GUIDES

#### A - single

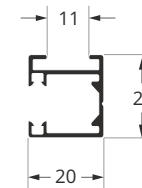

#### B - for sets

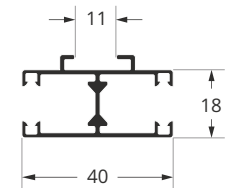

### SIDE GUIDES' BRACKETS

Available brackets variants:

- A1** 50-70 mm
- A2** 71-105 mm
- A3** 106-170 mm
- A4** 171-295 mm

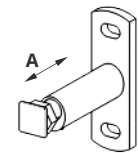

### MASKING COVER

#### Type 1

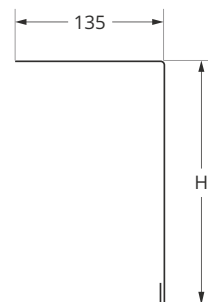

#### Type 2

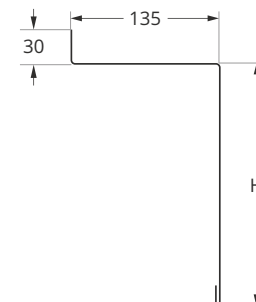

### Price list of masking covers

Net prices in Euro

H height and cover type	price	varnishing
220 mm – type 1	36,00 € / rm	10,30 € / rm
220 mm – type 2	36,00€ / rm	11,00 € / rm
260 mm – type 1	55,00 € / rm	11,30 € / rm
260 mm – type 2	55,00 € / rm	12,00 € / rm
300 mm – type 1	55,00 € / rm	12,30 € / rm
300 mm – type 2	55,00 € / rm	13,30 € / rm
350 mm – type 2	55,00 € / rm	13,80 € / rm
350 mm – tyep 1	55,00 € / rm	14,50 € / rm
380 mm – type 2	55,00 € / rm	14,50 € / rm
380 mm – type 1	55,00 € / rm	15,30 € / rm
side cover	7,00 € / pcs.	2,80 € / pcs.

Z90 CLASSIC facade jalousies																					Net prices in Euro, dimensions in mm	
height of masking cover	total height of jalousie	width																			surcharge for guides in RAL colour (2 pieces)	number of handles of guides pair
		800	900	1000	1100	1200	1300	1400	1500	1600	1700	1800	1900	2000	2100	2200	2300	2400	2500	2600		
220	800	158	165	170	176	181	187	192	198	204	220	227	232	237	243	248	253	259	265	271	3,50	4
	900	167	171	178	184	190	197	202	208	214	233	239	245	251	257	262	268	274	281	285	4,00	
	1000	174	180	187	193	199	205	213	218	226	245	251	258	264	271	277	283	290	296	303	4,25	
	1100	180	187	195	202	208	216	222	230	236	257	263	271	277	284	292	297	305	311	318	5,00	
	1200	187	195	202	210	217	226	233	239	247	268	275	283	292	297	305	312	319	326	334	5,25	
	1300	195	204	210	218	227	234	243	250	258	281	288	296	304	311	319	326	335	343	351	6,00	
	1400	202	210	218	227	236	245	253	261	269	293	300	308	316	324	333	341	349	357	366	6,25	
	1500	209	217	227	236	245	253	262	272	281	304	312	321	331	339	347	356	365	374	382	6,75	
260	1600	216	227	236	245	253	263	273	282	292	316	324	334	343	353	362	371	381	390	399	7,00	
	1700	223	234	245	253	263	274	282	293	303	328	337	346	357	366	376	385	394	404	414	7,50	
	1800	245	254	265	275	285	296	306	316	326	354	363	374	383	393	403	412	423	434	443	7,75	
	1900	252	262	274	284	294	305	316	328	337	365	376	385	396	406	418	428	439	449	460	8,50	
	2000	258	271	281	293	304	316	326	337	349	376	387	399	410	420	431	442	453	465	476	8,75	
	2100	265	277	290	301	312	324	337	347	359	389	401	411	423	435	447	458	468	481	492	9,25	
	2200	274	285	297	311	322	334	346	359	371	401	412	424	436	448	460	472	484	496	508	9,50	
	2300	281	294	305	318	331	345	356	369	382	412	424	437	449	462	474	486	499	511	523	10,00	
300	2400	288	301	314	326	340	354	366	381	393	424	437	450	463	476	489	501	514	527	539	10,25	
	2500	294	308	322	336	349	363	376	390	404	436	449	463	476	490	502	517	529	542	555	10,75	
	2600	301	316	324	345	357	373	386	401	415	448	462	475	489	502	517	530	544	558	571	11,25	
	2700	310	323	339	353	367	382	396	411	426	460	474	488	502	517	532	545	559	573	588	11,75	
	2800	316	331	346	362	376	391	406	421	436	472	486	500	515	530	545	559	574	589	605	12,00	
	2900	323	339	355	369	385	402	418	431	447	483	499	513	529	544	559	574	590	605	619	12,75	
	3000	331	346	363	378	394	410	427	442	459	495	511	527	542	558	573	589	605	620	636	13,00	
	3100	352	368	384	402	418	434	450	466	483	521	537	552	569	585	601	617	633	650	666	13,50	
350	3200	359	376	393	410	426	443	460	478	494	532	549	566	582	598	615	631	649	665	680	13,75	
	3300	366	383	401	418	436	453	470	488	506	544	561	578	595	612	630	646	664	680	697	14,50	
	3400	374	391	408	427	445	463	481	498	517	555	573	591	608	626	643	661	678	696	714	14,75	
	3500	381	399	418	436	453	472	490	509	527	568	586	605	621	639	657	676	694	712	729	15,25	
	3600	387	406	425	443	463	482	500	520	538	580	598	617	636	653	672	690	709	727	746	15,50	
	3700	394	414	434	453	472	492	511	529	549	592	610	630	649	668	686	705	724	743	760	16,00	
	3800	403	421	441	462	482	500	521	539	559	605	623	642	662	680	700	720	739	758	778	16,25	
	3900	410	429	449	469	490	510	530	550	570	615	636	654	675	695	715	733	755	774	793	16,75	
380	4000	416	437	458	479	499	521	539	561	582	627	648	668	687	708	728	748	768	788	810	17,00	
	4100	422	445	465	486	508	529	549	571	592	639	659	710	715	721	742	762	784	804	822	17,00	
	4200	430	452	474	495	517	539	559	583	603	651	671	723	728	735	756	777	799	820	898	17,25	
	4300	437	460	482	504	526	549	570	592	614	662	684	737	742	748	770	791	813	835	915	17,75	
	4400	444	467	489	511	535	558	579	603	625	674	696	748	756	762	785	806	829	851	932	18,00	
	4500	451	475	497	521	544	568	589	614	636	685	708	762	769	776	799	821	843	866	949	18,50	
	4600	470	494	518	541	565	589	610	636	658	709	732	787	794	802	824	847	870	893	978	18,75	
	4700	477	502	525	549	573	598	620	645	669	721	744	802	808	814	838	862	885	909	995	19,25	
380	4800	484	509	533	558	583	607	630	656	679	732	757	814	821	829	852	876	899	925	1012	19,50	
	4900	491	517	541	566	592	617	640	666	690	743	769	828	834	841	866	890	915	940	1029	20,25	
	5000	498	524	549	574	600	626	651	677	701	756	781	840	848	855	880	904	930	955	1046	20,50	
Bottom gutter in RAL		3,50	4,00	4,50	5,00	5,50	5,75	6,25	6,50	7,00	7,50	8,00	8,50	8,75	9,25	9,50	10,25	10,67	11,17	11,67		

The price of the system includes: **1.** The masking cover in the colour of raw aluminum. (surcharge for varnishing - table p. 15). **2.** Mounting brackets for the jalousie's rail. **3.** Slats, bottom gutter and guides in standard colours, in accordance with the table on page 25. **WARNING! NARROW JALOUSIES - ARROW EFFECT.** An arrow effect may occur on narrow jalousies with two winding mechanisms. This effect will occur if, during the rolling of the jalousies, the string from the ladder gets between the slats and causes an uneven increase in the thickness of the bundle on the left and right side. This effect is visible if the jalousie is narrow, and additionally may increase if the jalousie is narrow and high at the same time.

Z90 CLASSIC facade jalousies																					Net prices in Euro, dimensions in mm	
height of masking cover	total height of jalousie	width																			surcharge for guides in RAL colour (2 pieces)	number of handles of guides pair
		2700	2800	2900	3000	3100	3200	3300	3400	3500	3600	3700	3800	3900	4000	4100	4200	4300	4400	4500		
220	800	285	292	296	301	307	312	318	322	336	341	346	351	356	360	366	369	374	378	397	3,50	4
	900	303	308	314	319	325	331	336	343	357	362	367	373	378	383	388	393	397	402	423	4,00	
	1000	319	325	331	337	345	314	356	363	377	383	389	394	400	405	410	415	420	425	448	4,25	
	1100	336	343	349	356	363	368	376	383	399	404	410	417	422	428	435	439	445	450	475	5,00	
	1200	353	359	367	374	381	389	395	403	419	425	431	438	445	451	457	463	468	474	500	5,25	
	1300	369	377	384	392	400	408	415	422	439	447	453	460	466	474	480	485	492	498	525	6,00	
	1400	386	394	402	410	419	426	435	442	460	467	474	482	490	496	503	510	515	522	551	6,25	
	1500	403	411	420	428	437	445	453	462	480	489	496	504	511	520	526	533	541	547	577	6,75	
260	1600	420	429	437	447	454	465	473	482	500	509	517	525	533	542	549	555	563	570	601	7,00	
	1700	436	446	454	465	474	483	493	502	521	529	538	547	555	564	572	579	587	594	627	7,50	
	1800	466	476	485	496	506	515	525	536	555	564	573	582	592	601	609	616	624	633	668	7,75	
	1900	483	494	503	513	525	535	545	555	576	585	594	605	614	623	632	640	649	656	694	8,50	
	2000	500	511	521	532	543	554	564	576	595	605	615	625	635	645	654	662	671	679	719	8,75	
	2100	517	527	539	550	561	572	584	595	616	627	638	648	658	668	678	686	696	705	745	9,25	
	2200	533	545	557	568	580	592	605	615	637	648	659	669	680	692	701	711	720	729	771	9,50	
	2300	550	562	574	586	598	610	623	636	657	668	679	690	702	713	723	733	743	752	796	10,00	
300	2400	568	579	574	605	616	630	642	654	678	690	701	713	725	737	747	758	768	777	823	10,25	
	2500	585	597	592	623	636	649	662	675	698	711	723	735	747	759	769	780	790	802	848	10,75	
	2600	600	614	609	640	654	668	680	695	719	732	743	757	769	782	830	840	851	862	872	11,25	
	2700	617	631	628	659	673	686	700	714	740	753	766	778	792	804	854	866	876	888	899	11,75	
	2800	634	649	645	678	692	706	720	734	760	774	787	801	813	827	878	889	901	913	925	12,00	
	2900	651	666	662	695	710	724	740	755	781	794	808	822	835	849	902	914	926	938	950	12,75	
	3000	668	683	680	713	728	743	760	775	802	816	830	844	859	872	911	924	935	947	976	13,00	
	3100	697	714	697	744	760	776	791	807	834	849	864	878	893	908	919	932	945	980	1011	13,50	
	3200	715	729	729	762	778	795	811	828	854	870	885	900	915	930	943	956	969	957	1036	13,75	
	3300	732	747	746	781	797	813	830	847	876	892	908	923	939	954	966	980	993	980	1063	14,50	
350	3400	746	765	764	799	815	833	851	867	897	913	929	944	960	976	990	1003	1017	1005	1088	14,75	
	3500	764	781	781	817	834	853	870	888	917	933	949	966	982	998	1012	1025	1039	1029	1114	15,25	
	3600	781	799	799	834	853	870	889	907	938	955	972	989	1005	1022	1035	1050	1064	1053		15,50	
	3700	798	817	817	853	871	889	908	927	959	976	992	1010	1027	1044	1059	1073	1088			16,00	
	3800	815	833	834	871	889	910	928	947	978	996	1013	1032	1049	1067	1081	1096				16,25	
	3900	831	851	853	889	908	928	947	966	999	1018	1036	1054	1071	1089	1105					16,75	
	4000	847	868	870	908	927	947	966	987	1020	1038	1057	1076	1094	1112						17,00	
	4100	912	915	888	926	945	966	1042	1062	1069	1076	1078	1097	1116							17,00	
	4200	930	932	917	944	964	986	1062	1084	1091	1095	1099	1119								17,25	
	4300	948	950	935	961	982	1004	1082	1104	1108	1114	1121									17,75	
380	4400	965	969	953	980	1000	1023	1103	1125	1131	1181									18,00		
	4500	983	986	971	998	1019	1042	1124	1147	1184											18,50	
	4600	1013	1016	1018	1028	1049	1072	1156	1179												18,75	
	4700	1031	1033	1036	1045	1067	1090	1177	1201												19,25	
	4800	1049	1051	1054	1063	1086	1109	1197													19,50	
	4900	1066	1068	1071	1081	1104	1128														20,25	
5000	1083	1087	1089	1099	1123	1148														20,50		
Bottom gutter in RAL		12,17	12,67	13,17	13,67	14,17	14,67	15,17	15,67	16,17	16,67	17,17	17,67	18,17	18,67	19,17	19,67	20,17	20,67	21,17		

The price of the system includes: **1.** The masking cover in the colour of raw aluminum. (surcharge for varnishing - table p. 15). **2.** Mounting brackets for the jalousie's rail. **3.** Slats, bottom gutter and guides in standard colours, in accordance with the table on page 25. **WARNING! NARROW JALOUSIES - ARROW EFFECT.** An arrow effect may occur on narrow jalousies with two winding mechanisms. This effect will occur if, during the rolling of the jalousies, the string from the ladder gets between the slats and causes an uneven increase in the thickness of the bundle on the left and right side. This effect is visible if the jalousie is narrow, and additionally may increase if the jalousie is narrow and high at the same time.

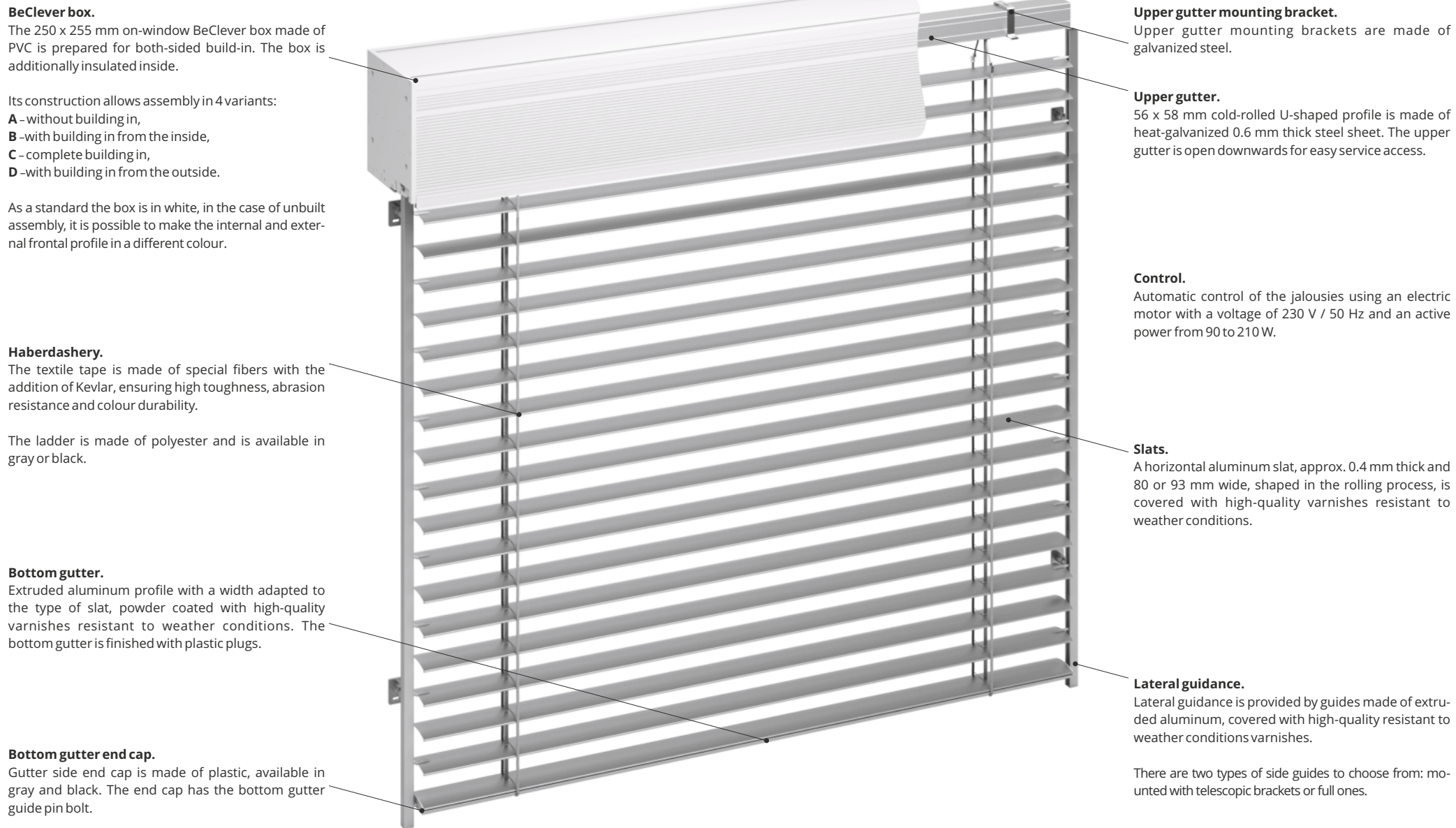

**BeClever box.**  
The 250 x 255 mm on-window BeClever box made of PVC is prepared for both-sided build-in. The box is additionally insulated inside.

Its construction allows assembly in 4 variants:  
**A** - without building in,  
**B** - with building in from the inside,  
**C** - complete building in,  
**D** - with building in from the outside.

As a standard the box is in white, in the case of unbuilt assembly, it is possible to make the internal and external frontal profile in a different colour.

**Haberdashery.**  
The textile tape is made of special fibers with the addition of Kevlar, ensuring high toughness, abrasion resistance and colour durability.

The ladder is made of polyester and is available in gray or black.

**Bottom gutter.**  
Extruded aluminum profile with a width adapted to the type of slat, powder coated with high-quality varnishes resistant to weather conditions. The bottom gutter is finished with plastic plugs.

**Bottom gutter end cap.**  
Gutter side end cap is made of plastic, available in gray and black. The end cap has the bottom gutter guide pin bolt.

**Upper gutter mounting bracket.**  
Upper gutter mounting brackets are made of galvanized steel.

**Upper gutter.**  
56 x 58 mm cold-rolled U-shaped profile is made of heat-galvanized 0.6 mm thick steel sheet. The upper gutter is open downwards for easy service access.

**Control.**  
Automatic control of the жалюзи using an electric motor with a voltage of 230 V / 50 Hz and an active power from 90 to 210 W.

**Slats.**  
A horizontal aluminum slat, approx. 0.4 mm thick and 80 or 93 mm wide, shaped in the rolling process, is covered with high-quality varnishes resistant to weather conditions.

**Lateral guidance.**  
Lateral guidance is provided by guides made of extruded aluminum, covered with high-quality resistant to weather conditions varnishes.

There are two types of side guides to choose from: mounted with telescopic brackets or full ones.

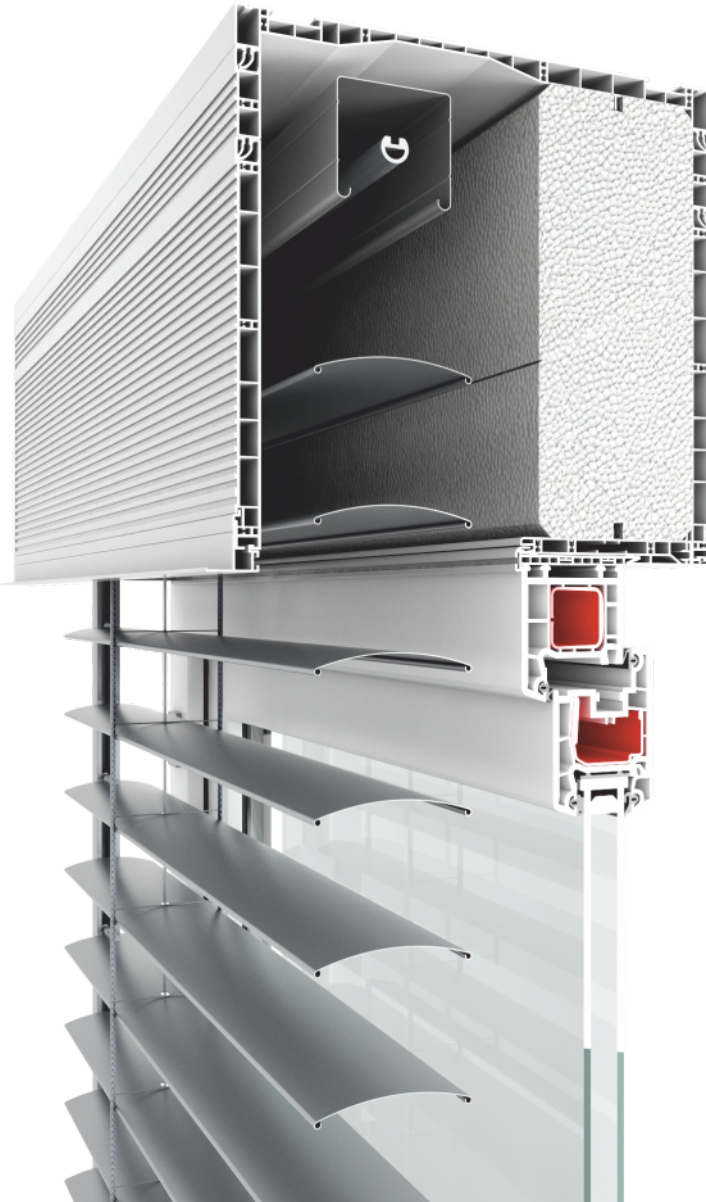

### SLATS PACKAGE

- 80 mm wide aluminum slat, painted with resistant to weather conditions varnish.
- as standard slat rotation 90°; 180° rotation for an additional charge of 5%.
- bottom gutter with dimensions of 80 x 13 mm.
- a textile tape made of special fibers with the addition of Kevlar.
- a package of jalousie as standard fixed with automatic brackets of the top rail mounting.
- max. jalousie dimensions: width: 4000 mm, height: 2500 mm, surface area according to the table.

### GUIDANCE THE SLAT

- side guidance with using of guides made of extruded aluminum. You can choose guides **A/B** mounted with telescopic brackets or full **C**,
- **A/B** guides are offered at no extra charge in a standard colour range (page 25). Full **C** side guides are available at an additional cost - table on page 22).

### CASE

- top-mounted box with dimensions of 250 x 255 mm made of PVC, white as standard,
- internal and external frontal profiles of the box in colour other than white at an additional charge (available colours on pages 22).
- box with the possibility of assembly in one of the 4 available variants: **A** - without building in, **B** - with building in from the inside, **C** - with complete building in, **D** - with building in from the outside.
- insulation of the box as a standard, Neopor insulation for an additional fee of 5 €/rm.

### DRIVE

- drives for an extra charge, table on page 26.
- depending of the size of the jalousie the appropriate drive power needs to be selected.

### BOX

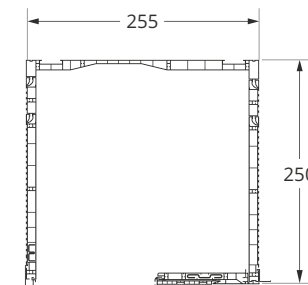

### SLAT

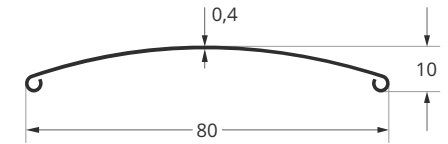

### GUIDES

**A** - single on telescopic brackets **B** - on telescopic brackets for sets

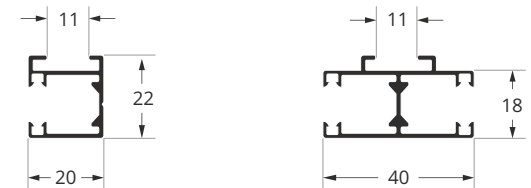

**C** - full side guide

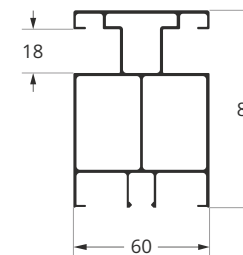

### GUIDE BRACKETS

BeClever external jalousies with **A/B** guides are only available with 50-70 mm brackets.

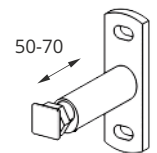





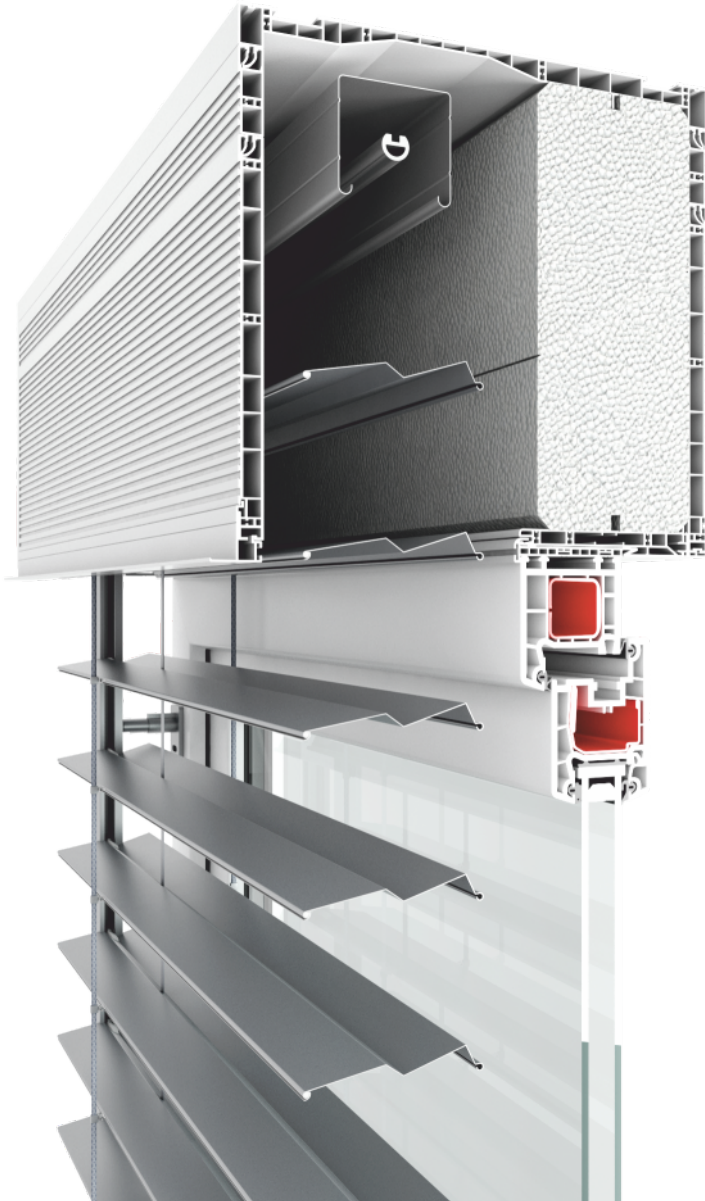

### SLATS PACKAGE

- 93 mm wide aluminum slat, painted with resistant to weather conditions varnish.
- bottom gutter with dimensions of 93 x 13 mm.
- a textile tape made of special fibers with the addition of Kevlar.
- a package of jalousie as standard fixed with automatic brackets to the top rail mounting.
- max. jalousie dimensions: width: 4000 mm, height: 2500 mm, surface area according to the table.

### GUIDANCE THE SLAT

- side guidance with using of guides made of extruded aluminum. You can choose guides **A/B** mounted with telescopic brackets or full **C**.
- **A/B** guides are offered at no extra charge in a standard colour range (page 25). Full **C** side guides are available at an additional cost - table on page 24).

### CASE

- top-mounted box with dimensions of 250 x 255 mm made of PVC, white as standard,
- internal and external frontal profiles of the box in colour other than white at an additional charge (available colours on pages 24).
- box with the possibility of assembly in one of the 4 available variants: **A** - without building in, **B** - with building in from the inside, **C** - with complete building in, **D** - with building in from the outside.
- insulation of the box as a standard, Neopor insulation for an additional fee of 5 €/rm.

### DRIVE

- drives for an extra charge, table on page 26.
- depending of the size of the jalousie the appropriate drive power needs to be selected.

### BOX

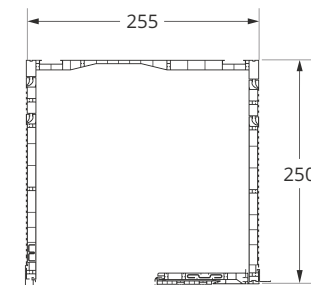

### SLAT

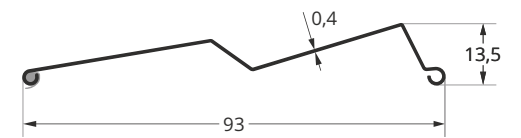

### GUIDES

**A** - single on telescopic brackets **B** - on telescopic brackets for sets

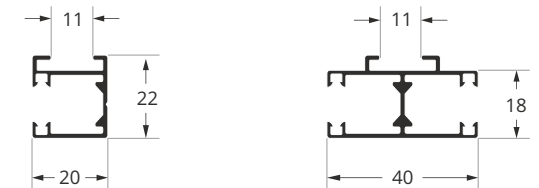

### C - full side guide

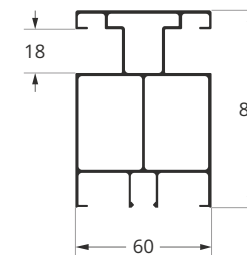

### GUIDE BRACKETS

BeClever external jalousies with **A/B** guides are only available with 50-70 mm brackets.

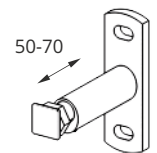

Facade top-mounted жалوسies Z90 in BeClever box																												Net prices in Euro, dimensions in mm				surcharge for A/B guides in RAL colour (2 pieces)	surcharge for C guides (2 pieces)*	number of handles of guides pair		
total height of жалوسie	width																																			
	800	900	1000	1100	1200	1300	1400	1500	1600	1700	1800	1900	2000	2100	2200	2300	2400	2500	2600	2700	2800	2900	3000	3100	3200	3300	3400	3500	3600	3700	3800	3900	4000			
800	452	466	479	492	505	518	531	543	594	619	632	645	657	671	683	696	709	721	774	795	808	820	833	846	858	872	883	904	954	967	979	991	1003	3,50	44,20	4
900	461	473	487	501	513	528	541	554	605	631	644	658	671	684	697	711	724	738	788	813	825	838	851	864	877	890	904	925	976	988	1001	1013	1026	4,00	46,80	
1000	468	482	496	509	523	536	551	563	617	644	656	670	684	699	711	726	740	752	806	829	842	855	869	883	897	909	924	945	996	1010	1022	1036	1048	4,25	49,40	
1100	474	489	503	519	532	547	560	575	627	656	668	684	697	711	726	740	754	767	821	846	859	873	887	902	915	929	944	967	1017	1032	1045	1058	1071	5,00	52,00	
1200	481	496	511	527	541	557	571	585	638	667	681	696	712	725	740	754	769	782	837	863	876	891	906	920	935	949	964	987	1038	1053	1066	1081	1093	5,25	54,60	
1300	489	505	519	534	550	565	581	596	649	680	694	708	724	738	754	769	785	799	853	878	894	908	924	938	954	969	983	1007	1060	1074	1088	1102	1117	6,00	57,20	
1400	496	512	527	544	559	575	591	607	659	691	706	721	737	752	767	784	799	814	869	896	910	927	942	958	973	988	1003	1028	1080	1096	1110	1125	1139	6,25	59,80	
1500	503	519	536	552	569	585	601	617	672	702	718	734	751	767	781	798	815	831	884	913	927	944	960	976	992	1007	1023	1048	1102	1117	1132	1146	1163	6,75	62,40	
1600	510	528	544	561	577	593	612	627	683	715	730	747	763	781	796	814	830	846	901	930	945	962	979	993	1011	1027	1043	1068	1122	1139	1153	1168	1184	7,00	65,00	
1700	517	535	553	569	586	604	620	638	694	727	743	759	778	794	810	827	844	861	916	946	962	979	996	1012	1029	1047	1063	1089	1143	1159	1175	1190	1207	7,50	67,60	
1800	539	555	574	592	609	626	645	662	717	753	769	787	803	820	838	855	872	890	945	976	992	1010	1028	1044	1061	1078	1097	1123	1178	1195	1210	1227	1243	7,75	70,20	
1900	546	564	582	600	618	636	655	673	728	763	781	797	816	834	853	871	888	905	963	993	1010	1027	1045	1064	1081	1098	1116	1144	1199	1216	1233	1249	1266	8,50	72,80	
2000	552	572	590	609	627	647	665	683	740	775	793	812	830	848	866	885	903	921	979	1010	1027	1045	1064	1081	1100	1118	1137	1163	1219	1236	1253	1270	1287	8,75	75,40	
2100	559	579	599	617	636	655	675	692	750	787	806	824	843	863	882	900	917	937	994	1027	1044	1063	1082	1100	1118	1138	1156	1184	1241	1259	1276	1293	1311	9,25	78,00	
2200	567	586	606	627	645	665	685	704	762	799	818	837	857	876	895	914	933	953	1011	1043	1061	1081	1100	1118	1138	1158	1176	1205	1262	1280	1297	1315	1335	9,50	80,60	
2300	575	595	614	635	655	675	694	714	773	811	830	850	869	890	909	929	948	968	1026	1060	1078	1098	1118	1137	1157	1177	1196	1225	1282	1301	1318	1337	1356	10,00	83,20	
2400	582	602	623	643	664	684	705	726	784	823	843	862	884	904	923	944	963	983	1042	1078	1095	1116	1137	1155	1176	1195	1215	1246	1303	1323	1341	1360	1380	10,25	85,80	
2500	588	610	630	652	673	694	715	736	795	835	854	876	896	918	937	960	980	999	1058	1094	1113	1133	1155	1175	1196	1216	1236	1266	1325	1344	1363	1382	1401	10,75	88,40	

Bottom gutter in RAL																																
3,50	4,00	4,50	5,00	5,50	5,75	6,25	6,50	7,00	7,50	8,00	8,50	8,75	9,25	9,50	10,25	10,67	11,17	11,67	12,17	12,67	13,17	13,67	14,17	14,67	15,17	15,67	16,17	16,67	17,17	17,67	18,17	18,67

Frontal profile colour																																	
internal	6,76	8,06	9,36	10,92	12,22	13,5	14,82	16,12	17,68	18,98	20,28	21,58	22,88	24,44	25,74	27,04	28,34	29,64	31,20	32,50	33,80	35,10	36,40	37,70	39,00	40,30	41,60	42,90	44,20	45,50	46,80	48,10	49,40
external	6,76	8,06	9,36	10,92	12,22	13,5	14,82	16,12	17,68	18,98	20,28	21,58	22,88	24,44	25,74	27,04	28,34	29,64	31,20	32,50	33,80	35,10	36,40	37,70	39,00	40,30	41,60	42,90	44,20	45,50	46,80	48,10	49,40

**WARNING! NARROW JALOUSIES - ARROW EFFECT.** An arrow effect may occur on narrow жалوسies with two winding mechanisms. This effect will occur if, during the rolling of the жалوسies, the string from the ladder gets between the slats and causes an uneven increase in the thickness of the bundle on the left and right side. This effect is visible if the жалوسie is narrow, and additionally may increase if the жалوسie is narrow and high at the same time.

**System's price includes:**

- box to building in,
- mounting brackets of жалوسie's rail,
- slats package with bottom gutter according to the colour chart on page 25.
- two **A/B** guides with telescopic brackets in the colours according to the colour chart on page 25.

**Surcharges:**

- drive and electric control – page 26.
- varnishing the **A/B** guides in a colour other than available in the colour chart on page 25 (table above),
- **C** guides painted in the selected RAL colour (see table above), (the price includes cost of side guides and their varnishing on any RAL colour)
- varnishing of the bottom gutter (the table above),
- external/internal frontal profiles of the box other than white (table above).

**Colours of the internal and external frontal profile available at an additional cost:**

- gray (renolit 715505)
- anthracite (renolit 701605)
- smooth anthracite (renolit 701605-083)
- nut (renolit 2178007)
- golden oak (renolit 2178001)
- basalt (renolit 701205)
- basalt smooth (renolit 701205-083)
- jet black matt
- alux DB

		SLATS								
		PREMIUM SYSTEM		CLASSIC SYSTEM		BeClever BOX			****	
		C80 PREMIUM	Z90 PREMIUM	C80 CLASSIC	Z90 CLASSIC	C80 BeClever	Z90 BeClever	„BOX“ CASES	GUIDES	BOTTOM GUTTERS
WHITE	RAL 9016	✓	✓	✓	✓	✓	✓	✓***	✓	✓
SILVER	RAL 9006	✓	✓	✓	✓	✓	✓	✓***	✓	✓
SILVER GRAY	RAL 9007	✓	—	✓	—	✓	—	✓***	✓	✓
ANTHRACITE STRUCTURE	DB 703	✓	✓	✓	✓	✓	✓	✓***	✓	✓
ANTHRACITE	RAL 7016	✓	✓	✓	✓	✓	✓	✓***	✓	✓
BASALT GRAY	RAL 7012	✓	✓	✓	✓	✓	✓	✓***	✓	✓
BEIGE	VSR 240	✓	—	✓	—	✓	—	✓***	✓	✓
BLACK	RAL 9005	✓	✓	✓	✓	✓	✓	✓***	✓	✓
BROWN	RAL 8028	✓	—	✓	—	✓	—	surcharge * RAL 8028	surcharge * RAL 8028	RAL 8028 *
GOLDEN OAK		surcharge 50%	—	surcharge 50%	—	surcharge 50%	—	surcharge * RAL 8003 MAT	surcharge * RAL 8003 MAT	RAL 8003 MAT **
NUT		surcharge 50%	—	surcharge 50%	—	surcharge 50%	—	surcharge * RAL 8028 MAT	surcharge * RAL 8028 MAT	RAL 8028 MAT **
GRAY ALUMINUM		—	surcharge 22%	—	surcharge 32%	—	surcharge 22%	surcharge * RAL 9007 MAT	surcharge * RAL 9007 MAT	RAL 9007 MAT **
GRAPHITE STRUCTURE		—	surcharge 22%	—	surcharge 32%	—	surcharge 22%	surcharge * DB 703 MAT structure	surcharge * DB 703 MAT structure	DB 703 MAT structure **
DARK GRAY		—	surcharge 22%	—	surcharge 32%	—	surcharge 22%	surcharge * RAL 7037 MAT	surcharge * RAL 7037 MAT	RAL 7037 MAT **
GRAY NATURAL		—	surcharge 22%	—	surcharge 32%	—	surcharge 22%	surcharge * RAL 7030 MAT	surcharge * RAL 7030 MAT	RAL 7030 MAT **

**WARNING!** Through using various techniques of covering the surface with a varnish layer, there is a possibility of differences in shades between the colours of the slats and the case of the facade jalousie (bottom gutter, guide, guide holders and a masking cover).

**\* - surcharges marked with an asterisk.**

Additional payments for varnishing marked with an asterisk should be valued according to the varnishing price lists, which can be found on the following pages:

- BOX PREMIUM cases - page 11/12,
- BOX PREMIUM guides - page 13 or in tables with systems' prices,
- CLASSIC and BeClever guides in tables with systems' prices.

**\*/\*\* - colours marked with an asterisk.**

As it is not possible to use a color identical to the colour of the slats, these are the RAL colours that are the closest to the slats' colours.

**\*\*\* - „BOX“ CASES**

The price without additional payment applies to the varnishing variant of "standard" cassette. Other varnishing variants on page 11/12.



**\*\*\*\* - GUIDES**

**WARNING!** The given colour scheme of the guides does not apply to the full C guide in the BeClever top-mounted system.

**ELERO electric motors**

Products name	Torque	Speed	Net price
<b>Ja Soft</b> – drives with mechanical limit switches			
<b>JA 06 Soft</b>	6 Nm	26 rev/min	101,50 €
<b>JA 09 Soft</b>	9 Nm	26 rev/min	119,50 €
<b>JA 20 dk</b>	20 Nm	26 rev/min	239,25 €
<b>Ja Comfort</b> – drives with electronic limit switches			
<b>JA 06 Comfort</b>	6 Nm	26 rev/min	158,50 €
<b>JA 09 Comfort</b>	9 Nm	26 rev/min	176,75 €
<b>Ja Comfort-868</b> – drives with electronic limit switches, built-in radio receiver			
<b>JA 06 Comfort-868</b>	6 Nm	26 obr/min	189,75
<b>JA 09 Comfort-868</b>	9 Nm	26 obr/min	221,00

**ELERO electric control**

<b>COMBIO-868 JA Pulse</b> - radio receiver (to the box)	114,50 €
<b>MONOTEC-868</b> - mural remote control	41,50 €
<b>MONOCOM 1 Slider</b> - 1-channel white remote control (possibility of tilting the slats)	75,50 €
<b>VARIOCOM 6 Slider</b> - 6-channel white remote control (possibility of tilting the slats)	98,75 €
<b>MULTITEL 2</b> - 15-channel remote control with display, manual / automatic switch-key	137,75 €
<b>ASTROTEC-868</b> - surface-mounted mural sender with a clock, manual / automatic switch-key	156,00 €
<b>AERO-868</b> - power supply - built-in radio solar cell, wind and sun sensor	286,00 €
<b>AERO-868 AC</b> - 230 V mains supply, radio wind and sun sensor	299,00 €

**MOBILUS receiver**

<b>C-ZR</b> - radio receiver	78,00 €
<b>HCT</b> - 24-channel remote control with a clock	163,75 €
<b>HM</b> - 99-channel remote control	91,00 €

**SOMFY electric motors**

<b>Wired motors – electronic limit switches</b>			
<b>SOMFY WT 6 Nm</b>	6 Nm		114,50 €
<b>SOMFY WT 9 Nm</b>	9 Nm		130,00 €
<b>SOMFY WT 20 Nm</b>	20 Nm		156,00 €
<b>Wired motors – electronic limit switches with obstacle detection</b>			
<b>Somfy WT PROTECT 6 Nm</b>	6 Nm		135,25 €
<b>Somfy WT PROTECT 9 Nm</b>	9 Nm		156,00 €
<b>Somfy WT PROTECT 20 Nm</b>	20 Nm		189,75 €
<b>Radio motors – electronic limit switches with obstacle detection</b>			
<b>SOMFY J4 IO protect 6 Nm</b>	6 Nm		286,00 €
<b>SOMFY J4 IO protect 9 Nm</b>	9 Nm		306,75 €
<b>SOMFY J4 IO protect 20 Nm</b>	20 Nm		345,75 €

**SOMFY electric control**

<b>Cable control</b>			
<b>Smoove UNO WT 5P</b> (five-positional)			31,25 €
<b>Smoove DUO WT 5P</b> (five-positional)			41,50
<b>Radio control SOMFY IO</b>			
<b>TAHOMA SWITCH</b> - online IO & RTS installation manager			374,50 €
<b>SET&amp;GO IO</b> - starting device			226,25 €
<b>NINA TIMER</b> - remote control - individual, group control and time automatics			299,00 €
<b>SITUO 1 IO VARIATION A/M PURE</b> - remote control with adjustment of slats angle			85,75 €
<b>SITUO 5 IO VARIATION A/M PURE II</b> - remote control with adjustment of slats angle			109,25 €
<b>SMOOVE UNO A/M. IO</b> - controller with IO Pure remote control receiver			163,75 €
<b>ODBIORNIK IZYMO PURE IO</b> - mounted under the switch			163,75 €
<b>SMOOVE ORIGIN 1 PURE IO</b>			72,50 €
<b>EOLIS WIRE FREE IO</b> - battery powered wind sensor			153,50 €
<b>EOLIS IO</b> - ind sensor powered with the voltage of 230 V			156,00 €
<b>SOLIRIS IO</b> - wind-solar sensor powered with the voltage of 230 V			239,25 €



# Order form.

External facade jalousies  
**BOX PREMIUM.**

Guidance by use of guides.

Fart Produkt Ltd. Limited partnership, Towarowa street 3, 87-100 Toruń,  
tel. +48 56 623 55 77, export@fartprodukt.pl, www.fartprodukt.pl.

\* Bracket ( 0 - none, / 10 / 20 / 40)

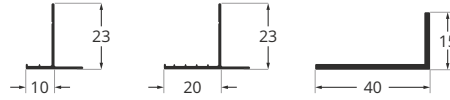

\*\* Varnishing variants (0 standard with no surcharge. 1, 2 and 3 - surcharge).

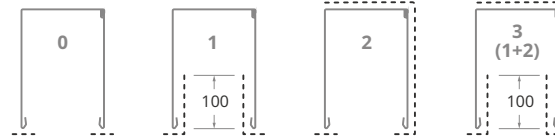

\*\*\*

A - mounting in the recess  
B - mounting to the window

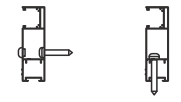

Drilling holes in guides

Ordinal number	Slat			Total width [mm]	Height [mm]		Quantity [pcs.]	Box						Colour of Fart Produkt colour palette			*** Drilling holes in guides A / B	Plugs of the guides (in black)		Textiles colour		Side of cable output (from the within) L \ R (left / right)	Motor 1 / 2 / 3 / 4 / 5	Accessories and additions			
	C80 slats rotation 90°	C80 slats rotation 180° surcharge 5%	Z90		Of window <input type="checkbox"/>	Total <input type="checkbox"/>		Height	* Bracket		Onduterm mat	XPS		** Varnishing	Colour of varnishing	Slats		Guides	Bottom gutter	Straight	Slanted (5%)				Gray	Black	
									Back	Front		Back	Front														
									10 <input type="checkbox"/>	20 <input type="checkbox"/>		40 <input type="checkbox"/>	10 <input type="checkbox"/>							20 <input type="checkbox"/>	40 <input type="checkbox"/>						

NOTES / DRAWINGS FROM THE INSIDE	Order no	Transport	Selection of covers height				Motors - description:  <b>1. SOMFY J4WT</b> electronic limit switches. <b>2. SOMFY J4WT PROTECT</b> electronic limit switches, obstacle and ice detection for move up. <b>3. SOMFY IO</b> motor with radio receiver, electronic limit switches.  <b>4. ELERO JA Soft</b> or <b>DK</b> electro-mechanical limit switches, soft version with soundless brake. <b>5. ELERO JA Comfort 868</b> motor with radio receiver, obstacle and ice detection for move up.  The price list of remote controls, switches and accessories for motors can be found on page 26. Please mark the choice in the table and provide the specific model in the "NOTES" field.
	Order date	Completion date	Height of jalousie	C80 CASSETTE	Height of jalousie	Z90 CASSETTE	
	Stamp and signature of commissioning party		800 - 900 mm	200 mm	800 - 1700 mm	200 mm	
			901 - 1700 mm	240 mm	1701 - 2500 mm	240 mm	
				2301 - 3200 mm	350 mm	2501 - 3500 mm	300 mm

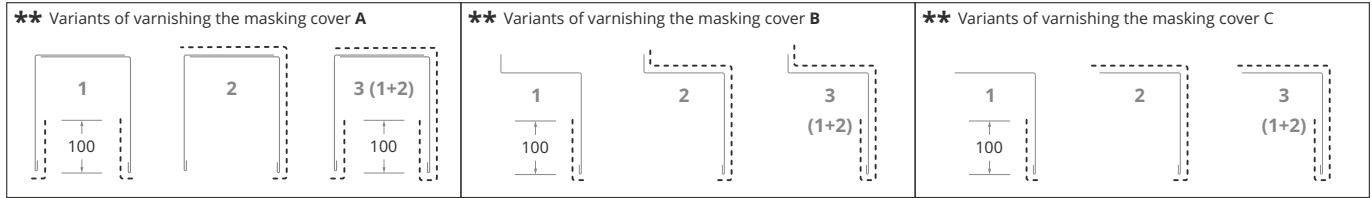

Ordinal number	Slat			Total width [mm]	Height [mm]		Quantity [pcs.]	*	Type of covering sheet metal	Lateral lidding of covering sheet metal	Colour of Fart Produkt colour palette					Textiles colour		Guides				Set	Side of cable output (from the within) L \ R (left \ right)	Motor 1 / 2 / 3 / 4 / 5	Accessories and additions			
	C80 slats rotation 90°	C80 slats rotation 180° surcharge 5%	Z90		<input type="checkbox"/> Of window	<input type="checkbox"/> Total					Slats	Guides	Bottom gutter	Varnishing of the masking cover **	Colour of varnishing	Gray	Black	*** Left	**** Brackets type	*** Right	**** Brackets type							
																										Color of Fart Produkt colour palette	Color of Fart Produkt colour palette	Color of Fart Produkt colour palette

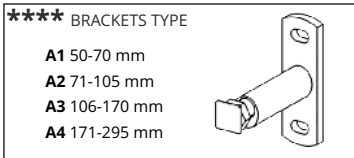
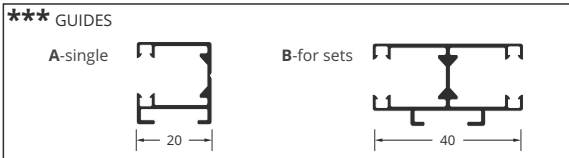
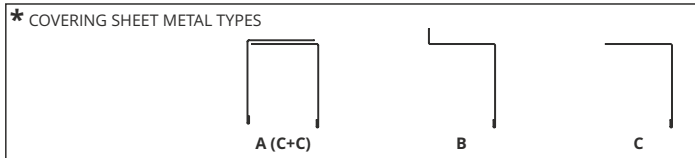

Height of jalousie	Selection of covers height			
	C80 Masking cover	Height of jalousie	Z90 Masking cover	Height of jalousie
800 - 1600 mm	220 mm	800 - 1700 mm	220 mm	
1601 - 2300 mm	260 mm	1701 - 2600 mm	260 mm	
2301 - 3200 mm	300 mm	2601 - 3500 mm	300 mm	
3201 - 4200 mm	350 mm	3501 - 4500 mm	350 mm	
4201 - 5000 mm	380 mm	4501 - 5000 mm	380 mm	

Order no \_\_\_\_\_ Transport \_\_\_\_\_

Order date \_\_\_\_\_ Completion date \_\_\_\_\_

Stamp and signature of commissioning party \_\_\_\_\_

**Motors - description:**

- SOMFY J4WT** electronic limit switches.
- SOMFY J4WT PROTECT** electronic limit switches, obstacle and ice detection for move up.
- SOMFY IO** motor with radio receiver, electronic limit switches.
- ELERO JA Soft** or **DK** electro-mechanical limit switches, soft version with soundless brake.
- ELERO JA Comfort 868** motor with radio receiver, obstacle and ice detection for move up.

The price list of remote controls, switches and accessories for motors can be found on page 25. Please mark the choice in the table and provide the specific model in the "NOTES" field.

# Order form.

External facade jalousies with top-mounted **BeClever box**.

Guidance by use of guides.

Fart Produkt Ltd. Limited partnership, Towarowa street 3, 87-100 Toruń,  
tel. +48 56 623 55 77, export@fartprodukt.pl, www.fartprodukt.pl.

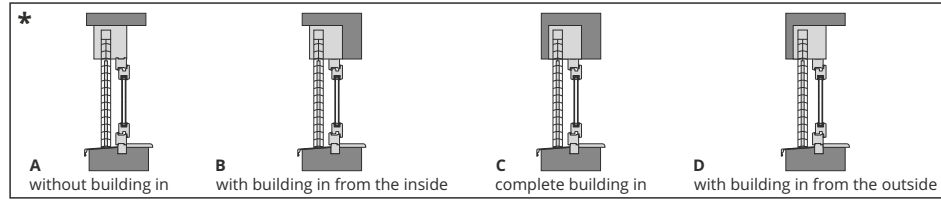

Available colours of the box frontal profile (the box is white as standard, other colours at an additional charge) \*\*\*

1. gray (renolit 715505)	6. basalt (renolit 701205)
2. anthracite (renolit 701605)	7. basalt smooth (renolit 701205-083)
3. smooth anthracite (renolit 701605-083)	8. jet black matt
4. nut (renolit 2178007)	9. alux DB
5. golden oak (renolit 2178001)	

Ordinal number	Slat			Total width [mm]	Height [mm]		Quantity [pcs.]	Box			** Guides A / B / C		Set	Colour of Fart Produkt colour palette			RAL colour	Textiles colour		Motor 1 / 2 / 3 / 4 / 5	Accessories and additions
	C80 slats rotation 90°	C80 slats rotation 180° surcharge 5%	Z90		Of window <input type="checkbox"/>	Total <input type="checkbox"/>		Installation type A/B/C/D	* Colour of frontal profile		Left	Right		Slats	Bottom gutter	Guides (A and B)	Guides C (surcharge)	Gray	Black		
									*** internal (applies to A/D mounting)	*** external (applies to A/B mounting)											
									***												

	Order no	Transport
	Order date	Completion date
	Stamp and signature of commissioning party	

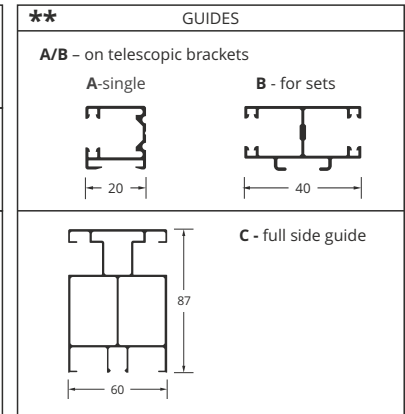

**Motors - description:**

- SOMFY J4WT** electronic limit switches.
- SOMFY J4WT PROTECT** electronic limit switches, obstacle and ice detection for move up.
- SOMFY IO** motor with radio receiver, electronic limit switches.
- ELERO JA Soft** or **DK** electro-mechanical limit switches, soft version with soundless brake.
- ELERO JA Comfort 868** motor with radio receiver, obstacle and ice detection for move up.

The price list of remote controls, switches and accessories for motors can be found on page 26. Please mark the choice in the "NOTES" field and provide the specific model in the "NOTES" field.

## General Provisions

1. General Terms and Conditions of Sale shall apply to the sale of products of the Fart Produkt sp. z o.o. sp.k. company having its registered office in Toruń at ul. Towarowa 3, entered into the National Court Register under the number 0000615850.
2. The sale shall be made to the economic operators cooperating with Fart-Produkt, hereinafter referred to as Trading Partners.
3. Price list does not constitute an offer within the meaning of the Civil Code.
4. Trading Partner is a separate, economic operator independent of the Fart-Produkt.
5. Trading Partners operate in their own name and on their own account.
6. Trading Partner may use trademarks of Fart-Produkt only with the consent of Fart-Produkt or only for the purpose of identifying Fart-Produkt as the manufacturer of a product.
7. All trade information obtained from Fart-Produkt shall be confidential and should not be disclosed by Trading Partner to any third parties.
8. Business Days within the meaning of this Terms and Conditions of Sale shall mean days from Monday to Friday excluding public holidays.

## Obligations and Liabilities of Trading Partner

1. Having relevant expertise for the purpose of optimal selection of products from the wide range of products offered by Fart-Produkt.
2. Having relevant expertise for the purpose of proper assembly of products from the wide range of products offered by Fart-Produkt.
3. Providing customers with true information about products from the wide range of products offered by Fart-Produkt.
4. Displaying advertising materials and relevant information about Fart-Produkt as the manufacturer of the products.
5. Providing guarantee services during the guarantee period.
6. Providing post-guarantee services according to individual agreements with customers.
7. Handling of customer complaints pertaining to the products offered by Fart-Produkt, in accordance with the complaints procedure.
8. Protecting good reputation and corporate image of Fart-Produkt by providing reliable service, proper assembly as well as providing maintenance services on products from the wide range of products offered by Fart-Produkt.
9. Ensuring that proper storage conditions will be maintained for products delivered by Fart-Produkt, including proper display of products offered by Fart-Produkt.

## Prices

1. Prices of products offered by Fart-Produkt are indicated in price list valid on a given date. Prices quoted are net prices. VAT should be added to the given prices at the rate applying on the date when the tax obligation arises.
2. Prices indicated in price lists of Fart-Produkt are expressed in Euro.
3. Prices indicated in price lists of Fart-Produkt are recommended retail prices, on which discount will apply for Trading Partner. Discounts shall be settled individually.
4. Prices indicated in price lists do not include assembly.
5. Fart-Produkt reserves the right to modify the price

list. Any modification to the price list will be communicated to Trading Partners when published on the site [www.fartprodukt.pl](http://www.fartprodukt.pl), via e-mail and by sales representatives of Fart-Produkt.

## Orders

1. Trading Partner shall place Orders in writing using order forms prepared by Fart-Produkt.
2. Order forms shall be delivered together with price lists and are available on the site [www.fartprodukt.pl](http://www.fartprodukt.pl).
3. Orders can be placed via fax or internet. By placing an order Trading Partner accepts the General Terms and Conditions of Sale and Trading Partner shall bear full responsibility for the content of order, which he has placed.
4. Orders placed in other form than by order forms will extend the order completion period and Fart-Produkt shall not be responsible for interpretation of data included in such orders.
5. Any modifications of orders require written form and they will extend the order completion period.
6. If an order is in progress the costs related to any modification of such order will be borne by Trading Partner.
7. Non-standard orders as well as orders under which lacquering of elements of finished product is required will extend the order completion period to 3 weeks.
8. Placing an order is considered as acceptance of the General Terms and Conditions of Sale.

## Terms of payment

1. Trading Partner is obliged to pay for ordered and purchased products on the date indicated in the invoice. The payment deadline shall be the date on which bank account of Fart-Produkt has been credited.
2. The terms, like: advance payments, form and the payment deadline will be determined individually for every Trading Partner.
3. If Trading Partner exceeds the payment deadline it may result in charging statutory interest for late payment by Fart-Produkt, suspension of execution of successive orders, refusal to deliver ordered products, modifying the terms of payment.
4. In case the payment deadline has been exceeded and compulsory enforcement of payment due to Fart-Produkt by debt collection agency is necessary, then Trading Partner authorises Fart-Produkt to charge Trading Partner with costs related to recovery of due amount.

## Guarantee

1. Fart-Produkt shall provide a 24-month guarantee for delivered products to Trading Partner.
2. The guarantee period shall commence on the date of issuing an invoice to Trading Partner.
3. Guarantee provided by Fart-Produkt shall be valid only with a relevant document confirming the purchase of the product i.e. VAT invoice or receipt.
4. Trading Partner shall act as the Guarantor to customer.
5. Assembly of products of Fart-Produkt shall be performed by dedicated and trained assembly teams, otherwise the guarantee rights shall be deemed null and void.
6. The guarantee does not cover:
  - damage caused by Trading Partner or persons for whom Trading Partner shall be responsible as well as damage caused by third parties.
  - natural wear and tear of the products, incorrect

assembly, incorrect start-up, inappropriate use of the product, impact of external factors.

- discoloration and other changes in the surface properties of elements caused by the influence of atmospheric factors as well as differences in the shades of colours between template and a real finished product.
  - defects of indentations, scratches, damages, if they resulted from inappropriate transport of products by Trading Partner.
  - damages resulting from random events (fire, flood, etc.)
  - damages resulting from improper storage of products by Trading Partner.
  - oversized products ordered on special request of Trading Partner.
7. Trading Partner shall bear the costs of transport to the place of complaint.
  8. In case of unjustified call for expert of Fart-Produkt to the place of complaint, Fart-Produkt shall charge Trading Partner with the costs incurred.
  9. Interference in visual elements of products, i.e. removing stickers, logo, rating plates shall result in the loss of guarantee rights.
  10. Trading Partner shall lose the guarantee rights in case Trading Partner or any third parties will make any modifications or unauthorised repairs of the products.
  11. Guarantee will cover damages caused by courier company only in case of writing a proper damage protocol in the presence of the courier by Trading Partner.

## Final Provisions

1. Any disputes which may arise between Fart-Produkt and Trading Partner, if they cannot be settled amicably, will be dealt with by common courts, with jurisdiction over the registered office of Fart-Produkt.
2. Any matters not provided for in the provisions of Cooperation Agreement or the General Terms and Conditions of Sale shall be governed by the Civil Code.

## All rights reserved.

The property rights to texts, drawings, photos and all other information published in this price list belong to Fart Produkt Ltd. limited partnership, Towarowa street 3, 87-100 Toruń. It is forbidden to use, duplicate, distribute or modify the submitted graphic materials in a manner other than specified in the contract with Fart Produkt Ltd. limited partnership, Towarowa street 3, 87-100 Toruń. Fart Produkt Ltd. limited partnership, Towarowa street 3, 87-100 Toruń reserves the right to withdraw consent to the use, reproduction, distribution or modification of received graphic materials.

Fart Produkt Ltd. Limited partnership,  
Towarowa street 3, 87-100 Toruń,  
tel. +48 56 623 55 77,  
[www.fartprodukt.pl](http://www.fartprodukt.pl), [export@fartprodukt.pl](mailto:export@fartprodukt.pl)





ul. Towarowa 3  
87 - 100 Toruń  
tel. + 48 56 623 55 77  
[www.fartprodukt.pl](http://www.fartprodukt.pl)  
e-mail: [export@fartprodukt.pl](mailto:export@fartprodukt.pl)

